

# Temporary Conditions

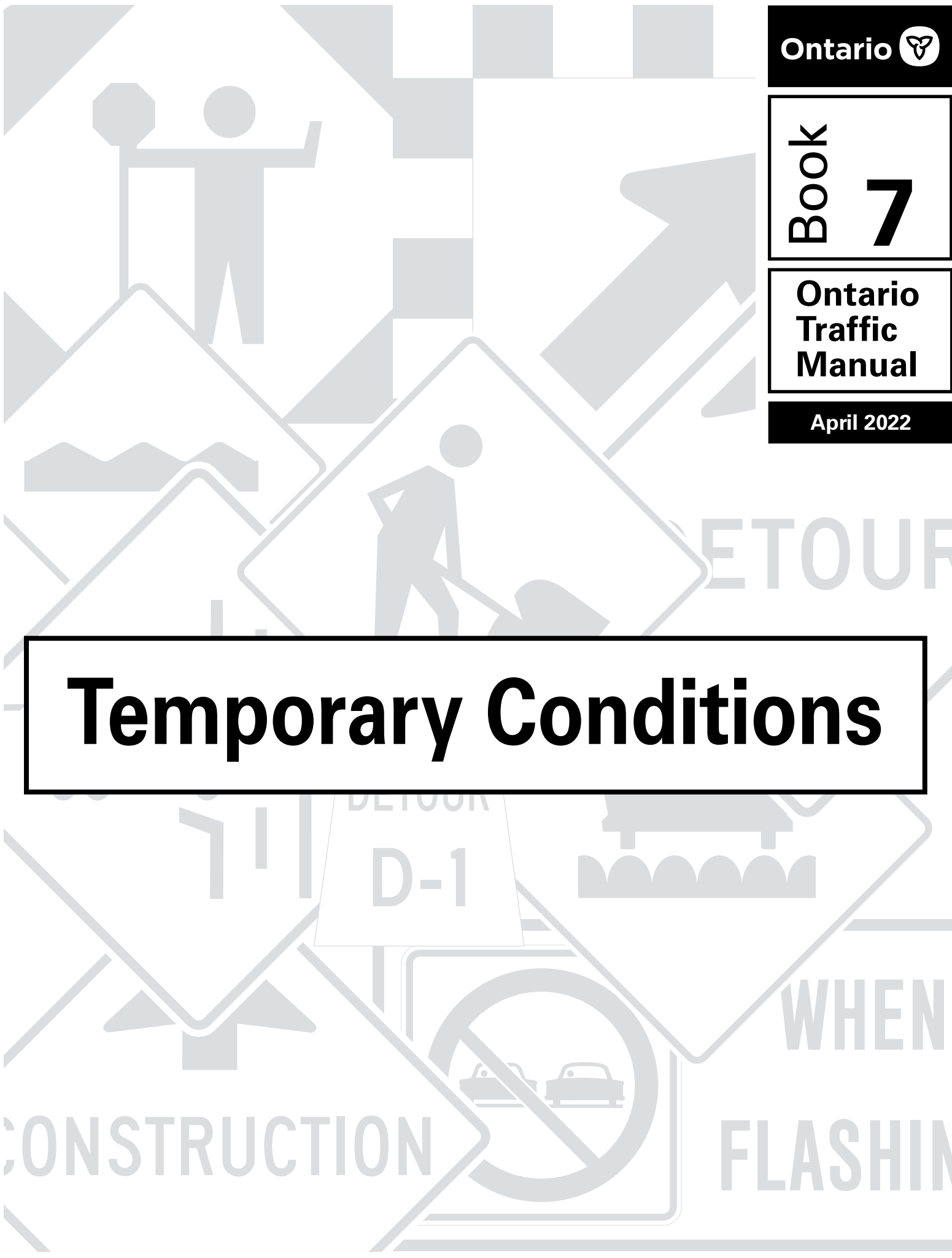



Ontario 



# Temporary Conditions

---

Ontario Traffic Manual  
April 2022

Cette publication hautement spécialisée, Ontario Traffic Manual – (OTM) Book 7 – Temporary Conditions, Office and Field Edition, n'est disponible qu'en anglais conformément au Règlement 671/92, selon lequel il n'est pas obligatoire de la traduire en vertu de la Loi sur les services en français. Pour obtenir des renseignements en français, veuillez communiquer avec le ministère des Transports par courriel à [OTM@ontario.ca](mailto:OTM@ontario.ca).

**ISBN 978-1-4868-5850-7 (PDF)**

**ISBN 978-1-4868-5849-1 (Print)**

Copyright © 2022

Queen's Printer for Ontario

All rights reserved.

## Foreword

---

The purpose of the Ontario Traffic Manual (OTM) is to provide information and guidance for transportation practitioners and to promote uniformity of treatment in the design, application and operation of traffic control devices and systems across Ontario. The objective is safe road user behaviour, achieved by a predictable roadway environment through the consistent, appropriate application of traffic control devices. Further purposes of the OTM are to provide a set of guidelines consistent with the intent of the Highway Traffic Act and to provide a basis for road authorities to generate or update their own guidelines and standards. The OTM is made up of a number of Books, which are continuously updated.

The OTM is directed to its primary users, traffic practitioners. The OTM incorporates current best practices in the province of Ontario. The interpretations, recommendations and guidelines in the OTM are intended to provide an understanding of traffic operations and they cover a broad range of traffic situations encountered in practice. They are based on many factors which may determine the specific design and operational effectiveness of traffic control systems. However, no manual can cover all contingencies or all cases encountered in the field. Therefore, field experience and knowledge of application are essential in deciding what to do in the absence of specific direction from the Manual itself and in overriding any recommendations in this Manual. The traffic practitioner's fundamental responsibility is to exercise engineering judgement and experience on technical matters in the best interests of the public and workers. Guidelines are provided in the OTM to assist in making those judgements, but they should not be used as a substitute for judgement. Design, application and operational guidelines and procedures should be used with judicious care and proper consideration of the prevailing circumstances.

In some designs, applications, or operational features, the traffic practitioner's judgement is to meet or exceed a guideline while in others a guideline might not be met for sound reasons, such as space availability, yet still produce a design or operation which may be judged to be safe. Every effort should be made to stay as close to the guidelines as possible in situations like these, and to document reasons for departures from them.

## Custodial Office

Inquiries about amendments, suggestions or comments regarding the OTM or about training sources may be directed to:

Ministry of Transportation, Ontario  
Traffic Office  
301 St. Paul Street, 2nd Floor  
St. Catharines, Ontario L2R 7R4  
Email: [otm@ontario.ca](mailto:otm@ontario.ca)  
Tel: (905) 704-2960  
Fax: (905) 704-2888

## Acknowledgements

### Technical Working Groups

#### Project Management/Technical Writing

Sheri Graham, Ministry of Transportation  
Roger De Gannes, Ministry of Transportation  
Tracey Difede, Ministry of Transportation  
Ron Lewis, Ministry of Transportation  
Michael Pardo, Ministry of Transportation  
Anthony Di Lorenzo, Ministry of Transportation

#### Project Consultant Team

Margot Smeenk, EXP  
Blake Gordon, EXP  
Minsu Kee, EXP  
Yves-Marie Monereau, EXP  
Maurice Masliah, Headlight Consulting  
Peter Wehmeyer, Direct Traffic Management Inc.

#### Unplanned Events

Luis Mendoza, OPP  
Michael Zelasko, OPP

**Stakeholder Advisory Committee**

Chris Arsenault, Ministry of Transportation

Dan Ferguson, Cox Construction

Dennis O'Neil, AORS

Donald Graham, City of Waterloo

Frank Pinder, Ministry of Transportation

Geoff Wilkinson, Ontario Traffic Council

James Delamere, Stinson Owl-Lite

Joanna Bruce, Ministry of Transportation

Joe Doyle, Miller Group

Joe Richards, Ontario Traffic Control Contractors Association

Peter Vujic, Region of Niagara

Rich Shebib, City of Hamilton

Ryan McHugh, City of Mississauga

Ruhi Sharma, MLTSD

Sandy De Lorenzi, Ministry of Transportation

Stephen Lyon, City of Ottawa

Steve Anderson, OPP

Tony Cristilli, OPP

Thanks to

Entro Communications Inc.:

Rachel Wallace and Vincent-Matthieu Gratton

# Table of Contents

<b>1</b>	<b>Introduction</b>	<b>1</b>
1.1	Purpose of the Manual	2
1.2	Legal Authority	3
1.3	Training	4
<b>2</b>	<b>Temporary Work Zone Planning and Monitoring</b>	<b>6</b>
2.1	Fundamental Principles for Work Zone Planning, Design, and Operation	6
2.2	Transportation Management Planning Process	7
2.2.1	Collect Project Information (Step 1)	8
2.2.2	Identify, Assess, and Manage Risks (Step 2)	9
2.2.2.1	Consider Hierarchy of Risk Controls (Step 2a)	11
2.2.2.2	Assess Work Zone Impacts (Step 2b)	12
2.2.3	Develop Traffic Control Plan(s) (Steps 3, 4, and 5)	13
2.2.3.1	Select Relevant Layout (Step 3)	13
2.2.3.2	Develop Traffic Control Plan by Applying or Modifying Layout(s) to Address Site Specifics (Step 4)	13
2.2.3.3	Develop Traffic Protection Plan (Step 5)	13
2.2.4	Develop Additional Plan(s) (as required) (Step 6)	14
2.2.4.1	Other Plans (If Required)	14
2.3	Implementation and Monitoring	16
2.3.1	Obtain Approvals (Step 7)	16
2.3.2	Implementation (Step 8)	17
2.3.3	Monitoring (Step 9)	17
<b>3</b>	<b>Temporary Work Zone Design</b>	<b>18</b>
3.1	Fundamental Principles of Work Zone Design	18
3.2	Defining the Highway Environment	20
3.2.1	Area Type (Urban or Rural)	21
3.2.2	Highway Type (Freeway or Non-Freeway)	23
3.2.3	Cross-Section (Two-Lane, Multi-Lane Divided or Undivided)	23
3.2.4	Traffic Volume (Low Volume or High Volume)	24
3.3	Configurations for Temporary Conditions	24
3.3.1	Off-Shoulder	25
3.3.2	Shoulder	25
3.3.3	Lane Encroachment	25
3.3.4	Partial Lane Shift(s)	26



3.3.5	Lane Closure(s) or Lane Occupied .....	27
3.3.6	Detours .....	28
3.3.7	Rolling Closures .....	29
<b>3.4</b>	<b>Component Areas for Temporary Conditions .....</b>	<b>30</b>
3.4.1	Advance Warning Area .....	31
3.4.2	Approach Area .....	32
3.4.3	Transition Area .....	32
3.4.4	Longitudinal Buffer Areas (LBA) .....	33
3.4.5	Work Area .....	34
3.4.6	Termination Area .....	34
3.4.7	Additional Considerations in Component Area Design .....	34
3.4.7.1	Ingress and Egress .....	34
3.4.7.2	Linear Space Restrictions .....	35
3.4.7.3	Horizontal and Vertical Clearance .....	37
<b>3.5</b>	<b>Duration of Work .....</b>	<b>37</b>
3.5.1	Mobile Operations .....	38
3.5.2	Intermittent Duration Work (ID) .....	39
3.5.3	Very Short Duration Work (VSD) .....	40
3.5.4	Short Duration Work (SD) .....	41
3.5.5	Long Duration Work (LD) .....	41
<b>3.6</b>	<b>Speed Management in Temporary Work Zones .....</b>	<b>42</b>
3.6.1	Guidelines for Posting Reduced Speed Limits in Construction Zones .....	44
3.6.2	Designating the Construction Zone .....	47
3.6.3	Turn Prohibitions and Other Regulations in the Construction Zone ..	48
<b>3.7</b>	<b>Active Road User Considerations .....</b>	<b>48</b>
3.7.1	Pedestrian Safety Considerations .....	49
3.7.1.1	Pedestrian Protection from the Work Zone .....	50
3.7.1.2	Pedestrian Travel Path .....	51
3.7.1.3	Temporary Pedestrian Crossings .....	52
3.7.1.4	Pedestrian Access Within Work Zones .....	52
3.7.2	Cyclist Safety Considerations .....	53
3.7.2.1	Cyclist Protection in the Work Zone .....	54
3.7.2.2	Modified/Temporary Cycling Facility .....	56
3.7.2.3	Change in Cyclist Facility Type .....	57
3.7.2.4	Cyclist Detours .....	58
<b>3.8</b>	<b>Visibility Considerations .....</b>	<b>58</b>
3.8.1	Night-time Provisions .....	58
3.8.2	Work Zone Lighting .....	59
3.8.2.1	Lighting of Work Area .....	59
3.8.2.2	Highway Lighting through a Work Zone .....	60
3.8.2.3	Anti-glare Screening .....	60

**4 Temporary Traffic Control Devices ..... 61**

**4.1 General Quality Guidelines for Traffic Control Devices ..... 62**

    4.1.1 Evaluation Guide for Traffic Control Devices ..... 64

**4.2 Devices for Channelization, Guidance, and Information ..... 68**

    4.2.1 Traffic Cones ..... 69

    4.2.2 Construction Marker ..... 70

    4.2.3 Flexible Drums (Barrel)..... 71

    4.2.4 Barricades ..... 72

    4.2.5 Temporary Construction Barrier System (TCBS) ..... 73

    4.2.6 Temporary Pavement Markings, and Highway Delineation ..... 73

        4.2.6.1 Temporary Pavement Markings ..... 73

        4.2.6.2 Orange Temporary Pavement Markings ..... 76

        4.2.6.3 Highway Delineators..... 77

    4.2.7 Signs ..... 79

    4.2.8 Traffic Control Sign Specifications ..... 81

        4.2.8.1 Sign Size ..... 81

        4.2.8.2 Sign Retro-Reflectivity Standards ..... 82

        4.2.8.3 Sign Material and Thickness ..... 83

        4.2.8.4 Positioning and Installation of Signs ..... 84

        4.2.8.5 Individual Sign Specifications – Static Message Signs ..... 88

    4.2.9 Typical Information Signs ..... 131

    4.2.10 Road Closing/Restriction Notice Sign (TC-64) ..... 138

        4.2.10.1 Road Closing/Restriction Notice Sign (Full-Time) ..... 138

        4.2.10.2 Physical Specifications for TC-64 Primary Signs, Auxiliary Signs, and Trailblazer Signs ..... 139

        4.2.10.3 Message Guidelines for TC-64..... 141

        4.2.10.4 Site Selection and Installation of TC-64 ..... 145

    4.2.11 Dynamic Message Signs and Devices ..... 145

        4.2.11.1 Portable Variable Message Sign (PVMS) ..... 146

        4.2.11.2 Physical Specifications for PVMS ..... 147

        4.2.11.3 Message Guidelines for PVMS..... 150

        4.2.11.4 Site Selection and Installation of PVMS ..... 153

        4.2.11.5 Flashing Arrow Board (TC-12) ..... 155

        4.2.11.6 Dynamic Speed Display Sign..... 159

        4.2.11.7 Supplementary Flashing Lights..... 161

        4.2.11.8 Queue-End Warning ..... 162

**4.3 Advance Notification, Advance Warning, and Alternate Route Signs ..... 165**

    4.3.1 Temporary Conditions Traffic Management (TCTM) Manual ..... 165

        4.3.1.1 Advance Notification Signing (ANS) ..... 165

        4.3.1.2 Advance Warning Signing (AWS)..... 166

        4.3.1.3 Alternate Route Signing (ARS) ..... 167

**4.4 Devices to Regulate and Control the Flow of Traffic ..... 169**

    4.4.1 Yield to Oncoming Traffic ..... 169

4.4.2	Traffic Control Persons (TCP) .....	169
4.4.2.1	Specifications for Use of TCP .....	170
4.4.2.2	TCP Qualifications and Equipment .....	171
4.4.2.3	TCP Position and Location .....	174
4.4.2.4	TCP Control Procedures .....	177
4.4.3	Temporary Traffic Control Using Signals .....	178
4.4.3.1	Automated Flagger Assistance Devices (AFAD) .....	178
4.4.3.2	Portable Lane Control Signals (PLCS) .....	182
4.4.3.3	Portable Temporary Traffic Signals (PTTS) .....	184
4.4.3.4	Temporary Traffic Signals (TTS) .....	188
4.4.4	Traffic Control Using Moving Vehicles .....	193
4.4.4.1	Pilot Vehicles .....	194
4.4.4.2	Pace Vehicles .....	195
4.4.4.3	Rolling Closures .....	197
4.4.5	Paid Duty Police Officers .....	199
4.4.6	Decision Matrices for the Use of Devices to Regulate and Control the Flow of Traffic .....	200
<b>4.5</b>	<b>Positive Protection Devices .....</b>	<b>205</b>
4.5.1	Buffer Vehicle (BV) .....	205
4.5.1.1	Truck Mounted Attenuator (TMA) and Buffer Vehicle (BV) Requirements .....	205
4.5.1.2	Placement of Buffer Vehicles Using Longitudinal and Lateral Intrusions .....	207
4.5.1.3	Lighting Standards on Buffer Vehicles and Work Vehicles .....	211
4.5.2	Glare Screens .....	211
4.5.3	Barriers .....	212
4.5.3.1	Temporary Concrete Barriers .....	213
4.5.3.2	Moveable Temporary Concrete Barriers .....	214
4.5.3.3	Temporary Steel Barriers (TSB) .....	214
4.5.3.4	Temporary Type M Steel Beam Guide Rail (Type M SBGR) .....	215
4.5.4	Ballast Filled Barriers .....	215
4.5.5	Energy Attenuators .....	216
4.5.6	Mobile Barriers .....	216
4.5.7	Vehicle Arresting Systems .....	217
4.5.8	Temporary Transverse Rumble Strips .....	217
<b>4.6</b>	<b>Monitoring of Contractor Compliance .....</b>	<b>219</b>
<b>4.7</b>	<b>Application of New Technologies .....</b>	<b>219</b>
<b>5</b>	<b>Set Up and Removal of Temporary Traffic Control .....</b>	<b>222</b>
<b>5.1</b>	<b>General Requirements .....</b>	<b>223</b>
<b>5.2</b>	<b>Freeway-Specific Requirements .....</b>	<b>224</b>
5.2.1	Set up of Freeway Lane Closures .....	225

5.2.1.1	Freeway Closure of Single Right or Left Lane (with Shoulders) .....	225
5.2.1.2	Freeway Closure of Two Right or Left Lanes (with Shoulders) .....	227
5.2.1.3	Freeway Closure of One or Two Right or Left Lanes (No Shoulder on Roadway Side where Lanes are being Closed) .....	228
5.2.2	<b>Removal (Take-down) of Freeway Lane Closures .....</b>	<b>231</b>
5.2.2.1	Removal of Single Right or Left Lane Closure (Freeway with Shoulders) .....	231
5.2.2.2	Removal of Two Right or Two Left Lane Closure (Freeway with Shoulders) .....	233
5.2.2.3	Removal of Two Right or Two Left Lane Freeway Closure (No Shoulder on Roadway Side where Lanes are being Closed) .....	235
5.2.3	Freeway Zone Painting .....	236
5.2.4	Freeway Paving .....	237
<b>6</b>	<b>Layouts for Signing Temporary Work Zone Situations .....</b>	<b>239</b>
6.1	<b>General Notes to Layouts .....</b>	<b>253</b>
6.2	<b>Legend of Symbols used in the Typical Layouts .....</b>	<b>256</b>
<b>A</b>	<b>Appendix A: Temporary Traffic Control for Unplanned Events .....</b>	<b>482</b>
<b>A.1</b>	<b>Introduction .....</b>	<b>482</b>
A.1.1	Scope .....	482
A.1.2	Definition of Unplanned Events .....	484
A.1.3	Traffic Control Guidelines .....	485
A.1.4	Unified Command .....	487
<b>A.2</b>	<b>Guidelines for First on Scene .....</b>	<b>488</b>
A.2.1	Identification of Hazards and Scene Evaluation .....	488
A.2.2	Estimated On-Scene Time – Extended Duration Scene .....	488
A.2.3	Lane Closure and Traffic Direction .....	489
<b>A.3</b>	<b>Equipment and Devices .....</b>	<b>490</b>
A.3.1	High Visibility Safety Apparel .....	490
A.3.2	Vehicle Lights and Flares .....	493
A.3.3	Emergency Signs .....	494
A.3.4	Traffic Cones .....	495
A.3.5	Manual Traffic Direction .....	496
A.3.6	Other Available Traffic Control Devices .....	497
<b>A.4</b>	<b>Placement of Cones/Flares .....</b>	<b>499</b>
A.4.1	Taper, Buffers and Incident Area .....	499
A.4.2	Conditions that Affect Cone Placement .....	500
<b>A.5</b>	<b>Positioning of Emergency Response Vehicles .....</b>	<b>502</b>

**A.6 Situations that Require Special Attention.....503**  
**A.7 Progression of Traffic Control .....504**

**B Appendix B: Glossary.....512**

**C Appendix C: References.....549**

# Tables

<b>Table 2.1</b> Fundamental Principles .....	7
<b>Table 2.2</b> Examples of Project Information for TMP .....	9
<b>Table 2.3</b> Potential Risk Factors .....	10
<b>Table 2.4</b> Hierarchy of Risk Control Measures .....	12
<b>Table 3.1</b> Urban and Rural Area Types .....	21
<b>Table 3.2</b> Freeway and Non-Freeway Highway Types .....	23
<b>Table 3.3</b> Cross-Section Types .....	24
<b>Table 3.4</b> Traffic Volume .....	24
<b>Table 3.5</b> Situations to Apply Partial Lane Shift .....	26
<b>Table 3.6</b> Linear Space Restrictions in Urban Non-freeway Areas .....	36
<b>Table 3.7</b> Linear Space Restrictions in Rural Non-freeway Areas .....	37
<b>Table 3.9</b> Posting of Reduced Speed Limits in Construction Zones: Appropriate Use of Advisory or Regulatory Speed Limit Signs .....	45
<b>Table 4.1</b> Quality of Acceptable Work Zone Devices .....	63
<b>Table 4.2</b> Minimum Dimensions of Work Zone Warning Signs .....	81
<b>Table 4.3</b> Minimum Retro-Reflectivity Requirements .....	83
<b>Table 4.4</b> Standard Sign Blank Descriptions (MTO) .....	84
<b>Table 4.5</b> Recommended Use for TCP .....	170
<b>Table 4.6</b> Recommended TCP Positioning Distances .....	175
<b>Table 4.7</b> Signal Visibility Table .....	183
<b>Table 4.8</b> Service Volume at Signalized Single Lane Construction Sites (Vehicles per Hour – One Way) .....	191
<b>Table 4.9</b> Vehicle Arrival Rates and Green plus Amber Times (Level of Service “E”) .....	191
<b>Table 4.10</b> Permissible Traffic Control for Alternating Two-way Traffic in Single Lane .....	201
<b>Table 4.11</b> Permissible Traffic Control for Intermittently Stopping Public Traffic .....	203
<b>Table A</b> Work Zone Component Dimensions: Mobile, Intermittent, and Very Short Duration Work (Non-freeways) .....	240
<b>Table B</b> Work Zone Component Dimensions: Short and Long Duration Work (Non-freeways) .....	241
<b>Table C</b> Work Zone Component Dimensions: Freeways .....	242
<b>Table D</b> Typical Usage of Signs through a Temporary Work Zone .....	243
<b>Table E</b> Usage of Channelizing Devices, Barricades, and Barriers .....	246
<b>Table F</b> Nomenclature for Layout Decision Matrix .....	247
<b>Table G</b> Decision Matrix: Layouts .....	248
<b>Table A.1</b> Typical Responders to Unplanned Events .....	483
<b>Table A.2</b> Progression of Traffic Control .....	486
<b>Table A.3</b> Scenario Examples of Appropriate HVSA Class Selection Based on Risk Level .....	491

# Figures

<b>Figure 2.1</b> Transportation Management Planning Process .....	8
<b>Figure 3.1</b> Component Areas .....	31
<b>Figure 4.1</b> Cones Quality Illustration .....	64
<b>Figure 4.2</b> Flexible Drums (TC-54 Barrels) Quality Illustration .....	65
<b>Figure 4.3</b> Work Zone Signs Quality Illustration .....	67
<b>Figure 4.4</b> Typical Sign Placement .....	85
<b>Figure 4.5</b> Static Queue-End Warning .....	163
<b>Figure 4.6</b> Dynamic Queue-End Warning .....	164
<b>Figure 4.7</b> Traffic Control Person Use of STOP/SLOW Paddle illustrates the TCP use of the STOP/SLOW paddle.	173
<b>Figure 4.8</b> Positioning of Traffic Control Persons .....	176
<b>Figure 4.9</b> Portable Lane Control Signal .....	183
<b>Figure 4.10</b> Signal Timing Calculations Examples .....	189
<b>Figure 4.11</b> Buffer Vehicles and LBA Scenarios .....	210
<b>Figure 5.1</b> Freeway Closure of Single Right or Left Lane (with Shoulders) .....	226
<b>Figure 5.2</b> Freeway Closure of Two Right or Left Lanes (with Shoulders) .....	228
<b>Figure 5.3</b> Freeway Closure of Two Right or Left Lanes (No Shoulder on Roadway Side where Lanes are being Closed) .	231
<b>Figure 5.4</b> Removal of Single Right or Left Lane Closure (Freeway with Shoulders) .....	233
<b>Figure 5.5</b> Removal of Two Right or Two Left Lane Closure (Freeway with Shoulders) .....	234
<b>Figure 5.6</b> Removal of Two Right or Two Left Lane Closure (No Shoulder on Roadway Side where Lanes are being Closed) .....	236
<b>Figure A.1</b> Placement of Cones/Flares .....	499
<b>Figure A.2</b> Longitudinal and Lateral Buffer Space .....	502
<b>Figure A.3</b> Incident on Shoulder (Non-freeway) .....	506
<b>Figure A.4</b> Incident on Shoulder (Freeway) .....	507
<b>Figure A.5</b> Incident in Live Lane (Two-Lane Highway) .....	508
<b>Figure A.6</b> Incident in Live Lane (Mutli-Lane Non-Freeway) .....	509
<b>Figure A.7</b> Incident in Live Lane (Freeway) .....	510
<b>Figure A.8</b> Typical Setup of Incident in Live Lane (Freeway) .....	511

# Signs and Devices

**Traffic Cones** ..... 69

TC-51A



TC-51B



TC-51C



**Construction Markers** ..... 70

TC-52



**Flexible Drums (Barrels)** ..... 71

TC-54



**Barricades** ..... 72

TC-53A



TC-53B

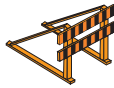

**Construction Ahead Signs** ..... 88

TC-1



TC-1A



TC-1B



**Road Work Signs** ..... 89

TC-2B



TC-2A



**Lane Closed Ahead Signs** ..... 91

TC-3R



TC-3L





**Lane Closed Tab Signs** ..... 92



**Lane Closure Arrow Signs** ..... 93



**Detour Ahead Signs** ..... 94



**Detour-Turn Off/Diversion Signs** ..... 95

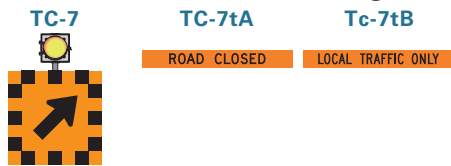

**Roadside Diversion Warning Signs** ..... 96



**Detour Designation Signs** ..... 97

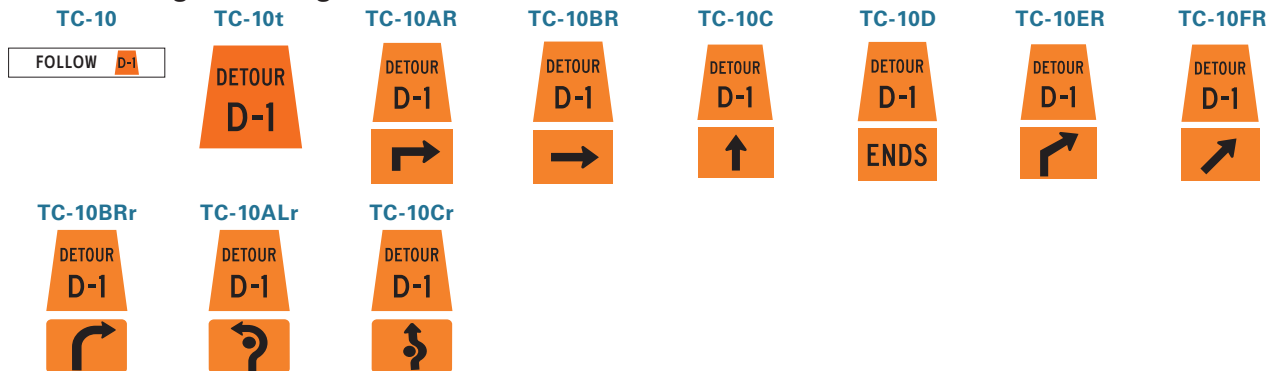

**Narrow Lanes Sign** ..... 99



**Trucks Use Centre Lane Tab Signs** ..... 99

TC-11t      TC-11tA



**Pavement Ends Sign** ..... 100

TC-13



**Bump Ahead Signs** ..... 101

TC-14      TC-15



**Turn and Curve Signs** ..... 102

TC-16AL      TC-16BL      TC-16CL      TC-16DL      TC-16EL      TC-16EL(2)      TC-16EL(3)



**Advised Speed Tab Sign** ..... 103

TC-17t



**Chevron Alignment Sign** ..... 104

TC-18



**Grooved Pavement Signs** ..... 105

TC-19      TC-19t



**Prepare to Stop Signs** ..... 106

TC-20      TC-20A      TC-20At



**Traffic Control Person (TCP) Ahead Sign . . . . . 107**



**Traffic Control Sign (STOP/SLOW Paddle). . . . . 108**



**Signals Ahead Sign . . . . . 109**



**Automated Flagger Assistance Device (AFAD) Signs. . . . . 110**



**Uneven Lanes Sign . . . . . 110**



**Do Not Pass When Flashing Sign . . . . . 111**



**Truck Entrance Signs . . . . . 112**

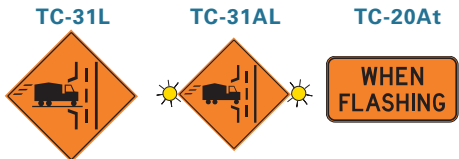

**Temporary Bridge Signs . . . . . 113**



**Low Bridge Ahead Signs** ..... 114



**Two-Way Traffic Sign** ..... 115



**Ramp Closed Ahead Sign** ..... 116



**Maximum Speed Advisory Sign** ..... 116



TC-36

**Soft Shoulders Sign** ..... 117



**No Exit Sign** ..... 118



**Pedestrian Direction Sign** ..... 118



**Bicycle Lane Detour Signs** ..... 119



**Bicycle Lane Closed Sign** ..... 120

TC-43



**Share the Road Signs** ..... 121

TC-101



TC-101t



TC-102



TC-102t



**Motor Vehicle Passing Prohibited Signs** ..... 122

Rb-66



Rb-66t



M204



**Dismount and Walk Sign** ..... 123

Rb-70



**Lane Designation Direction Sign** ..... 124

TC-25L



TC-25R



**Speed Fines Doubled Sign** ..... 124

TC-90

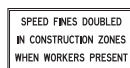

**Construction Zone Signs** ..... 125

Rb-90A



Rb-90B



**YIELD Sign** ..... 126

Ra-2



**Yield to Oncoming Traffic Signs** ..... 126



**Do Not Use Radio Transmitter Signs** ..... 127



**Road Closed Sign** ..... 128



**Turn Control Signs** ..... 129



**Keep Right or Keep Left Signs** ..... 130



**Turn Lane Designation Signs** ..... 130



**New Roadway Open Sign** ..... 132

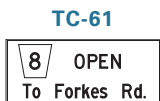

**Alternate Highway Route Sign** ..... 132

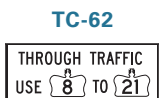

**Road Closing/Restriction Notice Sign (Full-Time) . . . . . 133**

TC-64

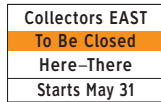

**Road Closing Notice Sign . . . . . 133**

TC-65



**Highway Section Closed Sign (Advance) . . . . . 134**

TC-66



**Street Section Closed Sign (Advance) . . . . . 134**

TC-67

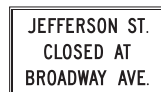

**Contract Identification Signs (Road Authority) . . . . . 135**

Sign                      Sign                      Sign                      Sign                      Sign



**Contractors Identification Sign . . . . . 136**

TC-75



**Contract Information Signs . . . . . 137**

TC-81A                      TC-81D



**The Portable Variable Message Sign (PVMS) . . . . . 146**

PVMS



**Flashing Arrow Boards** ..... **155**

TC-12 (left)    TC-12 (bar)    TC-12 (right)





## 1

## Introduction

Book 7 - Temporary Conditions (Office and Field Edition) is one of a series of volumes that makes up the Ministry of Transportation Ontario (MTO) Ontario Traffic Manual (OTM). The 2022 edition of OTM Book 7 is an update to the January 2014 edition.

OTM Book 7 addresses the application of traffic control devices in temporary work zones that result from highway activities such as:

- Planning.
- Construction.
- Surveying.
- Maintenance.
- Work by utility companies.
- Unplanned event responses.
- Other work within a public highway allowance.

OTM Book 7 should be read in conjunction with the following OTM series:

- OTM Book 1 (Introduction to the OTM) and its three appendices, which provide guidelines on the design and application of traffic control signs, signals, markings, and delineation devices.
- OTM Book 2 (Sign Design, Fabrication, and Patterns) for detailed information on the design and fabrication of individual signs including French language and bilingual versions of signs.
- OTM Book 4 (Ground-Mounted Sign and Support Inspection and Maintenance).
- OTM Book 5 (Regulatory Signs).
- OTM Book 6 (Warning Signs).
- OTM Book 8 (Guide and Information Signs).
- OTM Book 10 (Dynamic Message Signs).
- OTM Book 11 (Pavement, Hazard, and Delineation Markings).
- OTM Book 12 (Traffic Signals).
- OTM Book 15 (Pedestrian Crossing Treatments).
- OTM Book 18 (Cycling Facilities).

Other books in the OTM series provide practical guidance on a full range of traffic control devices and their applications.

A complete listing of the planned and current volumes is available to download for free at the Ministry of Transportation Ontario (MTO) website at [www.library.mto.gov.on.ca](http://www.library.mto.gov.on.ca).

Other documents, not in the OTM series, that should be referenced during the design of temporary conditions include:

- Transportation Association of Canada (TAC) Geometric Design Guide for Canadian Roads and its MTO Design Supplement.
- MTO Bikeways Design Manual (for Provincial highways).
- The MTO Roadside Design Manual.
- Ontario Provincial Standards for Roads and Public Works (OPS).
- Occupational Health and Safety Act (OHSA), R.S.O. 1990.
- Ontario Regulations for Construction Projects, O.Reg. 213/91.

The most up-to-date version of these documents should be referenced.

## 1.1 Purpose of the Manual

OTM Book 7 provides fundamental principles, guidelines, and current best practices for traffic control in temporary work zones with the goal of ensuring the protection of workers and the safe and efficient movement of highway users through work zones. Temporary works are not exclusive only to construction works, but they also include events such as road closures for parades and filming. Book 7 is intended for use by the following stakeholders:

- Road authorities (provincial, municipal, and private road owners) in Ontario and their contractors.
- Utilities, designers, enforcement officers, and others who may have approval to work on public highways.

### NOTE

Book 7 provides uniform guidelines for traffic control in temporary work zones.

Work zone safety depends on the application of several key elements which must work together as a system or a “safety chain”. These elements include:

1. Design of the highway, construction, and maintenance plan.
2. Traffic control plan that identifies all necessary elements.
3. Traffic Protection Plan for the protection of workers.
4. Training of all personnel involved in traffic control, and/or working on a highway.
5. Contractor compliance with traffic control and Traffic Protection Plans, including safe installation, application, and removal of all necessary traffic control elements.

### NOTE

Safety in highway work zones depends on the application of a number of key elements which must work together as a system or a “safety chain”.

6. Quality assurance checks of contractor compliance with traffic control.
7. Safe work habits on the part of workers.
8. Appropriate police enforcement.

Safety for highway users and workers is paramount, especially workers who set-up, operate, and remove traffic control measures. If a key element is weak or absent, safety may be compromised.

## 1.2 Legal Authority

**Ministry of Labour, Training and Skills Development (MLTSD)** – The MLTSD, through the Occupational Health and Safety Act (OHSA) and Regulations for Construction Projects, R.S.O. 1990 and O.Reg. 213/91 as amended, has the legal authority to regulate the safety of provincially regulated workers. This includes measures to protect workers from health and safety hazards on the job, including requirements related to traffic control persons (TCP) who direct traffic through or around a highway construction site.

While OTM Book 7 can be used as a tool to provide reasonable precautions that should be taken on construction projects, the OHSA and its regulations take precedence over OTM Book 7 in matters of worker safety and only the OHSA and its regulations are enforced by the MLTSD.

### NOTE

The OHSA and Regulations take precedence over OTM Book 7 in matters of worker safety.

**The Ministry of Transportation Ontario (MTO)** – The MTO, through the Highway Traffic Act (HTA), Public Transportation and Highway Improvement Act, and various related statutes, has the legal authority and responsibility to regulate and control traffic on a highway and regulate and control motor vehicles that operate in the province.

**Municipalities** – Individual municipalities have the legal authority and responsibility, through the Municipal Act and various regional municipality acts, to regulate and control traffic on their highways. The authority and responsibility also apply to construction and maintenance activities on highways.

**Road Authority** – Defined as the body (municipal or provincial) that has legal jurisdiction over a highway.

Traffic signs, pavement markings, traffic control signals, and other devices to regulate, warn, or guide traffic are to be installed only under the approval of the road authority.

When authorized, contractors, utility companies, or others may install temporary condition signs and devices to protect highway users, workers, and equipment, subject to the guidelines of Book 7, the OHSA and its regulations, and the requirements of the road authority.

Contractors may be authorized by the road authority to slow upstream traffic (e.g. rolling closures). The contractor may also implement short-term highway closures, as authorized by the road authority. It is the road authority's decision whether to use contractor staff or police for these operations.

Regulatory devices may need to be supported by applicable legislation, regulations, or by-laws. Effective traffic control requires both the appropriate application of traffic control devices and reasonable, effective enforcement.

## 1.3 Training

---

All users must be trained on how to use OTM Book 7 as well as develop an understanding of the general principles and theories shown throughout the manual. There are three types of users of the OTM Book 7:

1. Traffic Control Persons (TCP);
2. Workers who design traffic control plans; and
3. Workers who set-up, operate, and remove traffic control measures.

To achieve safe and effective traffic control appropriate training of involved in the planning and installation of traffic control systems is essential. Training outcomes are:

- Experience in the implementation of traffic control in the field, relevant to the work being done.
- A good working knowledge of all potential hazards.
- The ability to consider factors that impact communication to the driver.
- The ability to install effective traffic control setups that are safe for all road users.

Job specific training must be included for all users in accordance with the OHSA and the applicable regulations. Users should be trained using the Office Edition to fully understand how and when modifications to the layouts may be required.

- For more information on TCP, refer to [Section 4.4.2](#).
- Workers who design traffic control plans to protect both workers and road users:
  - a) Shall be a **competent** worker;
  - b) Shall be knowledgeable in standards and guidelines of OTM Book 7 and the Regulations for Construction Projects;
  - c) Shall be able to recognize the design elements of work zone traffic control; and

- d) Shall be given **adequate training** with respect to techniques and procedures for designing effective, efficient and safe traffic control plans.

Section **67 (6)** of the O.Reg. 213/91 for Construction Projects requires that the worker who **set up, operate, or remove measures** on a roadway or a shoulder of a roadway:

- a) Shall be a **competent** worker;
- b) Shall not perform any other work while setting up or removing the measures; and
- c) Shall be given **adequate written and oral instructions**, in a language that they understand, with respect to setting up or removing the measures.

Section **23** of the O.Reg. 145/00 requires that the worker who **directs vehicular traffic** that may be a hazard to workers on a public way:

- a) Shall not direct vehicular traffic for more than one lane in the same direction;
- b) Shall not direct vehicular traffic if the normal posted speed limit of the public way is more than 90 kilometres per hour;
- c) Shall be a **competent** worker;
- d) Shall not perform any other work while setting up or removing the measures; and
- e) Shall be given **adequate written and oral instructions**, in a language that they understand, with respect to directing vehicular traffic, and those instructions shall include a description of the signals that are to be used.

A **Competent worker** means a worker who:

- Is qualified because of knowledge, training and experience to perform the work;
- Is familiar with the *Occupational Health and Safety Act* and with the provisions of the regulations that apply to the work; and
- Has knowledge of all potential or actual danger to health or safety in the work.

**Public way** means a highway or other street, avenue, parkway, driveway, square, place, bridge, viaduct, or other open space to which the public has access, as of right or by expressed or implied invitation.

## 2

**Temporary Work Zone Planning and Monitoring**

Section 2 describes the process of transportation management planning and monitoring in temporary work zones.

Addressing worker safety, highway user safety, mobility, and accessibility requires careful consideration that starts early in project development and continues through to project completion. Early identification of project site-specific issues and potential traffic impacts can mitigate safety risk before construction commences.

A Transportation Management Plan (TMP) consists of a coordinated set of strategies and work zone safety guiding principles designed to mitigate the impacts of work zone activities during the work period. Inclusion of these strategies can help achieve the fundamental principles for work zone planning, design, and operation.

The TMP includes up to five sub-plans:

1. Traffic Protection Plan (mandatory).
2. Traffic Control Plan (requirement of road authority).
3. Traffic Operations Plan (optional).
4. Public Information Plan (optional).
5. Incident Management Plan (optional).

TMP is used to define and communicate, through a clear, consistent, and structured process, a comprehensive project-specific plan for use by project stakeholders such as local road authorities, contractors, ministry staff, and the general public.

Since work zone impacts and issues vary, TMP must be developed and implemented to best serve the unique needs of each work zone. The scope, content, and level of detail of a TMP may vary based on the local road authority's work zone policies and the anticipated work zone impacts of the project. The TMP is a living document and will evolve throughout the life cycle of the project.

## 2.1 Fundamental Principles for Work Zone Planning, Design, and Operation

The following fundamental principles, in [Table 2.1](#), provide the basis upon which work zones should be planned, designed, and operated. Ideally, each principle below will be fully incorporated into work zone design, however, since these principles are not always mutually exclusive, fully incorporating one

principle may comprise another. Practitioners who plan, design, or operate work zones must therefore strike the appropriate balance.

**Table 2.1 Fundamental Principles**

PRINCIPLE	DESCRIPTION
<b>Worker safety</b>	The safety of construction workers within the construction zone.
<b>Road user safety</b>	The safety of motorists, cyclists, pedestrians, transit users and enforcement/emergency personnel travelling through the construction zone.
<b>Mobility and accessibility</b>	Highway user movement should be inhibited as little as practicable. When this principle is followed, speed changes, and differentials are minimal and traffic progression is maintained, thereby increasing safety. Accessibility and mobility for pedestrians and cyclists is an important consideration.
<b>Communication and positive guidance</b>	Highway users should receive pertinent information at the times and locations needed to make appropriate decisions (e.g. speed or lane changes). Equipping highway users with clear, consistent, timely, and relevant information can help them prepare for unusual circumstances when approaching and navigating the work zone.
<b>Consistency and uniformity</b>	All messages should be consistent, unambiguous, easily, and quickly understood, and should provide only necessary information. Work zone design across the province should be kept consistent as practicable by following the guidelines in this manual.
<b>Constructability</b>	Projects should be planned, designed, and built as effectively and efficiently as possible to shorten the work duration and reduce cumulative risk exposure.

## 2.2 Transportation Management Planning Process

[Figure 2.1](#) presents the process (steps) for developing and implementing a TMP. Practitioners should begin developing the TMP early in the project planning process and should update the Plan frequently throughout project design and construction. Detailed guidelines for each step in the process are included in the following sections.

**Figure 2.1 Transportation Management Planning Process**

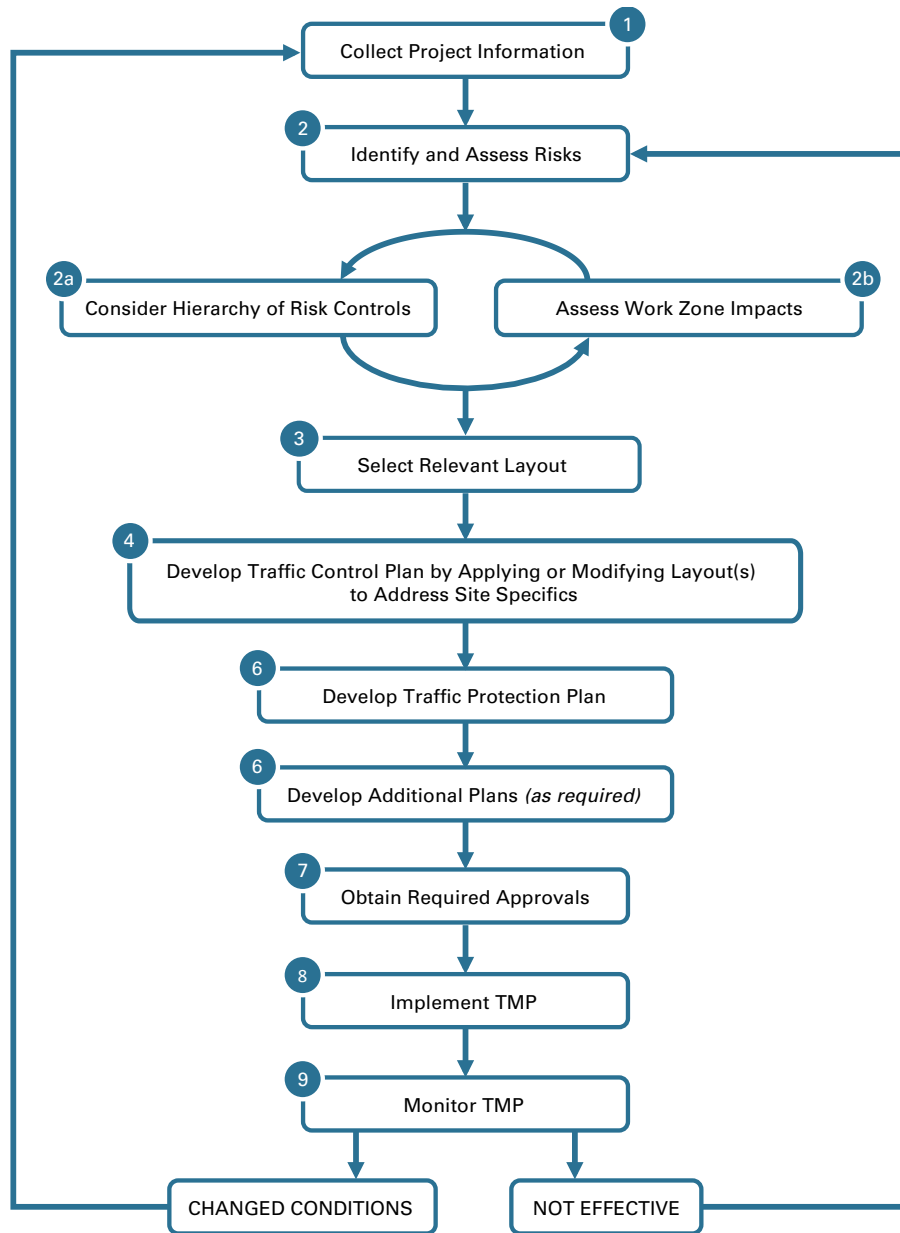

### 2.2.1 Collect Project Information (Step 1)

Table 2.2 presents examples of project information to be collected for the TMP, including references to Sections in the Manual where further information can be found. The level of detail required for the TMP will vary based on the scope of the project and requirements of the local road authority.

**NOTE**  
A site visit is an important and useful tool to observe and collect existing project area conditions.



Table 2.2 Examples of Project Information for TMP

CATEGORY	INFORMATION REQUIRED	SECTION
<b>TMP roles</b>	<ul style="list-style-type: none"> <li>• TMP team leader and team member roles and responsibilities.</li> <li>• Contact information for key personnel and stakeholders.</li> </ul>	
<b>Project description</b>	<ul style="list-style-type: none"> <li>• Project background.</li> <li>• Project location (area/corridor).</li> <li>• Project goals and constraints.</li> <li>• General schedule and timeline.</li> </ul>	
<b>Roadway environment</b>	<ul style="list-style-type: none"> <li>• Area type (urban or rural).</li> <li>• Highway type (freeway or non-freeway).</li> <li>• Cross-section (two-lane, multi-lane divided, or undivided).</li> <li>• Traffic volume (low volume or high volume).</li> <li>• Highway Design Speed.</li> <li>• Normal Posted Regulatory Speed (NPRS).</li> <li>• Operating Speed.</li> <li>• Presence of vulnerable highway users (pedestrians and cyclists).</li> <li>• Existing traffic operations (traffic controls, signal timing, signs).</li> <li>• Vertical profile and horizontal alignment (hills, valleys, and curves), sightlines, and visibility obstructions.</li> <li>• Other traffic data such as capacity, vehicle queues, vehicle type distribution, transit service, collision data (as applicable).</li> <li>• Information from other projects in the area to evaluate the combined impacts (if applicable).</li> </ul>	<p>3.2</p> <p>3.2</p> <p>3.2</p> <p>3.2</p>
<b>Work zone description</b>	<ul style="list-style-type: none"> <li>• Configuration of temporary conditions.</li> <li>• Location and length of work zone.</li> <li>• Duration of work.</li> <li>• Hours of work.</li> </ul>	<p>3.3</p> <p>3.4</p> <p>3.5</p>

### 2.2.2 Identify, Assess, and Manage Risks (Step 2)

The level of planning and effort required in preparing a TMP for a work zone is dependent on the expected worksite hazards and risks.

Assessing project hazards and risks is the process of:

- Reviewing site-specific characteristics;
- Identifying the hazards and risks; and
- Consideration of the likelihood and consequences of each.

A risk assessment process should be undertaken during initial preparation of the TMP, and the outcome should be used to develop appropriate strategies for managing and mitigating risks.

Early identification and documentation of risks that may arise during a project acts as a preliminary filter to separate work zones that require in-depth planning and preparation from those that do not.

Examples of factors which may result in greater risk may include, but are not limited to, the following presented in [Table 2.3](#):

**Table 2.3 Potential Risk Factors**

RISK FACTOR	DESCRIPTION
<b>Speed</b>	Higher speeds reduce the time a driver can recognize, interpret, and react to work zone conditions.
<b>Lateral space</b>	Workers are at greater risk of being injured by vehicles intruding into the work space when they are closer to a live lane of traffic, especially at higher speeds.
<b>Location of work</b>	Workers are at greater risk in areas with limited escape routes such as on bridge structures or other confined areas.
<b>Pedestrian and cyclist traffic</b>	Pedestrians and cyclists are vulnerable highway users and are at risk if not accommodated adequately.
<b>Project scope and duration</b>	Longer duration work zones increase the amount of cumulative time workers and highway users are exposed to safety risks.
<b>Anticipated traffic volumes</b>	High traffic volumes increase highway user and worker exposure to safety risks due to the number of potential conflicts.
<b>Time of day</b>	Night time work presents challenges such as visibility and conspicuity.
<b>Space restrictions (longitudinal)</b>	Work zones are considered higher risk if standard lengths for component areas ( <a href="#">Section 3.4</a> ) cannot be achieved due to space restrictions (e.g. driveways, side streets).
<b>Sight line restrictions</b>	Workers are at higher risk if adequate sight lines are not provided for drivers to recognize, interpret, and react to work zone conditions. Sight line obstructions may include horizontal and vertical curves (e.g. hills) or roadside obstructions.

RISK FACTOR	DESCRIPTION
<b>Observed safety issues</b>	Determine if the project location has a high collision history under typical conditions, if stakeholders are aware of any existing safety issues, or if any obvious safety issues were identified during a site visit. Locations with existing safety issues are considered higher risk.
<b>Inclement weather</b>	Conditions such as fog, snow, rain, and heavy winds can affect sight distance and stopping distance for vehicles.
<b>Intersections and driveways</b>	Intersections and driveways may cause longitudinal space restrictions (see above). In addition, intersections and driveways increase the number of movements and potential conflicts near the work zone.
<b>Condition of highway surface</b>	Highway surfaces in poor condition may affect driver maneuvering ability and stopping distance.
<b>Bus stops and bus lanes</b>	Buses make frequent stops and may increase potential for conflicts. Areas with bus service are more likely to have a higher pedestrian presence.
<b>Vehicle types (e.g. trucks)</b>	Large trucks have longer stopping distances and different sight lines than passenger vehicles.

Overall work zone risk should be assessed considering:

- Level of risk for individual factors.
- The number of contributing factors.
- Potential interaction between various risk factors.

For example, a narrow lateral buffer space presents a greater risk when operating speeds are higher.

### 2.2.2.1 Consider Hierarchy of Risk Controls (Step 2a)

A hierarchical approach should be used when considering and evaluating the control of risk in work zones, starting with the most effective approach and justifying decisions for implementing less-effective measures.

The fundamental principles of work zone planning, design, and operation (Section 2.1) and Steps 1, 2, and 2b of the TMP process should also be considered in the evaluation, and trade-offs between principles should be documented.

[Table 2.4](#) provides a hierarchy of risk control measures and examples of strategies for each. Noting that certain strategies may not be available, practical, or feasible, many work zones will require a combination of these strategies to best mitigate risk.

**Table 2.4 Hierarchy of Risk Control Measures**

PRINCIPLE	DESCRIPTION	EXAMPLE STRATEGIES
<b>1. Risk elimination (most effective)</b>	<ul style="list-style-type: none"> <li>Remove risk from work zone.</li> <li>Eliminate highway user and worker interaction.</li> </ul>	<ul style="list-style-type: none"> <li>Full highway or ramp closure.</li> </ul>
<b>2. Exposure control</b>	<ul style="list-style-type: none"> <li>Reduce exposure to potential conflicts between highway users and workers.</li> <li>Reduce number or proximity of vehicles travelling adjacent to workers.</li> </ul>	<ul style="list-style-type: none"> <li>Crossover.</li> <li>Diversion.</li> <li>Additional lane closure.</li> <li>Rolling closure.</li> </ul>
<b>3. Positive protection</b>	<ul style="list-style-type: none"> <li>Use positive protection devices to physically prevent highway users from leaving travelled path.</li> <li>Effective at protecting workers but may increase hazard to highway users.</li> </ul>	<ul style="list-style-type: none"> <li>Buffer Vehicles (<a href="#">4.5.1</a>).</li> <li>Barriers (<a href="#">4.5.3-4.5.4</a>).</li> <li>Vehicle arresting systems (<a href="#">4.5.5-4.5.6</a>).</li> </ul>
<b>4. Behavioural and administrative controls (least effective)</b>	<ul style="list-style-type: none"> <li>Controls to manage highway user and worker behaviour.</li> <li>Should be considered for all work zones even when higher-order controls are used.</li> </ul>	<ul style="list-style-type: none"> <li>Speed management techniques (<a href="#">3.6</a>).</li> <li>Traffic control devices (<a href="#">4.4-4.5</a>).</li> <li>Temporal work strategies (e.g., off-peak).</li> </ul>

### 2.2.2.2 Assess Work Zone Impacts (Step 2b)

Impacts of work zone design and operations strategies developed in the TMP should be understood by both the practitioner and the road authority. These impacts will affect decisions regarding the proposed design and operations strategies. During project life cycles, the TMP must be revised according to these impacts and the hierarchy of risk control treatments (Step 2a).

Examples of work zone impacts include:

- Traffic impacts such as delays to motorists, queues, and congestion.
- Impacts to other highway users such as pedestrians, cyclists, and transit.

In general, projects with higher risk, longer duration, and more disruptive configurations will require a detailed impact assessment, while others will require only a high-level impact assessment.

## 2.2.3 Develop Traffic Control Plan(s) (Steps 3, 4, and 5)

### 2.2.3.1 Select Relevant Layout (Step 3)

[Section 6](#) of this manual contains layouts for work zone design, including decision matrices to assist with selecting the most applicable layout, given work zone requirements and characteristics outlined in Step 1.

The layouts are organized by the following hierarchical structure:

Highway type and cross-section (e.g., multi-lane undivided)

Location type (general, segment, intersection or roundabout)

Closure type (shoulder, lane encroachment, lane closure, etc.)

Work duration or other characteristics

### 2.2.3.2 Develop Traffic Control Plan by Applying or Modifying Layout(s) to Address Site Specifics (Step 4)

Depending on the characteristics of the project work zone, a layout may be implemented without any modifications. However, work zones with greater risk (as determined in Step 2) may require modifications to the layout. Additionally, multiple layouts may be involved in developing the TMP due to different stages of work.

For high-risk complex projects, qualified and experienced practitioners should develop customized Traffic Control Plans based on layouts but designed specifically for the site.

### 2.2.3.3 Develop Traffic Protection Plan (Step 5)

A Traffic Protection Plan (TPP) is required under Ontario Regulation 213/91, Section 4-5 for all projects:

*“Every employer shall develop in writing and implement a traffic protection plan for the employers’ workers at a project if any of them may be exposed to a hazard from vehicular traffic. The traffic protection plan shall specify the vehicular traffic hazards and the measures ... to be used to protect workers; and shall be kept at the project and made available to an inspector or a worker on request.”*

If the core TMP has been developed as outlined, practitioners should be able to transcribe much of the content for the TPP from the TMP, including the Traffic Control Plans and other information related directly to the vehicular traffic hazards and associated protection measures for their workers.

According to the Ministry of Labour, an effective TPP may include:

- Assignment of roles and responsibilities for parties who may be exposed to traffic hazards.
- Training standards.
- Protective equipment requirements.
- Inspection procedures.
- Safe work procedures and practices.

## 2.2.4 Develop Additional Plan(s) (as required) (Step 6)

---

ATPP is required as part of the TMP for every project.

Depending on the type, complexity, and level of risk of the project, the following plans may also be used in developing the TMP:

- Transportation Operations Plan
- Public Information Plan
- Internal Traffic Control Plan
- Incident Management Plan

These Plans are described in the following Section.

### 2.2.4.1 Other Plans (If Required)

#### **Transportation Operations Plan (TOP)**

A Transportation Operations Plan (TOP) includes strategies used to mitigate work zone impacts using improved traffic operations and management techniques. Strategies include:

- Vehicle restriction strategies.

- Alternative traffic flow strategies.
- Improvements to the transportation network because of restrictions (signal timing modifications or detour routes).

Lessons learned from the past and/or recommendations previously made should be considered when developing a TOP.

### **Public Information Plan (PIP)**

A Public Information Plan (PIP) includes actions and procedures for informing:

- The travelling public;
- The general public;
- Area residences and businesses; and,
- The local road authority about expected work zone impacts.

Communication method(s) best suited for the project should be considered. These methods include:

- Public information centres;
- Broadcast on radio and television;
- Highway signs; and,
- Social media.

The Plan can help warn drivers of upcoming work zones and provide information to drivers both pre-trip and enroute, allowing drivers to make informed decisions about the route to take and when to travel.

### **Internal Traffic Control Plan (ITCP)**

An Internal Traffic Control Plan (ITCP) coordinates and assigns the flow of work vehicles, work equipment, and workers within the work zone to ensure worker safety and should include elements such as:

- Highway user paths.
- Work vehicle and equipment paths.
- Ingress and egress points.
- Storage and staging areas.

### **Incident Management Plan (IMP)**

An Incident Management Plan (IMP) outlines priorities and procedures for detecting and rapidly responding to unplanned events to minimize impact on:

1. The safety of workers and the public.
2. Mobility in order to restore traffic flow.

Following an incident, it is critical to document the events that initiated the incident so the TMP can be re-evaluated to determine if any changes are necessary.

## 2.3 Implementation and Monitoring

---

### 2.3.1 Obtain Approvals (Step 7)

---

Once the TMP and any required additional plans have been developed, approval must be obtained from all authorities having jurisdiction. The following steps should be taken to ensure the proper approvals have been received and notifications have been provided:

1. Ensure knowledge of all applicable regulations, permit requirements, and work restrictions.
2. Obtain the necessary approvals from the local road authority when:
  - a) Establishing a designated construction zone.
  - b) Posting reduced regulatory speed limits.
  - c) Using partial lane shifts.
  - d) Using portable or non-portable temporary traffic signals.
  - e) Conducting traffic control with moving vehicles other than for setup or removal.
  - f) Applying orange pavement markings.
  - g) Deploying Portable Variable Message Signs (PVMS).
  - h) Installing speed display signs.
  - i) Using a mobile barrier vehicle.
  - j) Applying a new technology.
3. Notify police, fire department, emergency medical services (EMS), transit authorities, road authority, and any other agencies which may be affected by the maintenance, construction, or other work activities.
4. Provide notice to the public of the works planned or in progress (as outlined in the Public Information Plan) through local media and signage.
5. Inform occupants of abutting properties, either orally or by written notice, of parking prohibitions or access limitations (as outlined in the Public Information Plan).



6. Discuss speed control and enforcement with the police and road authorities.

### 2.3.2 Implementation (Step 8)

---

Implementation of plans associated with the TMP should be completed as outlined in the TMP and additional plans, and according to all approval conditions from authorities having jurisdiction.

Methodology for the setup and removal of traffic control devices, utilized in the Traffic Control Plan, can be found in [Section 4](#).

### 2.3.3 Monitoring (Step 9)

---

The ongoing inspection and monitoring of work zones are important to ensure that the appropriate traffic control devices are in the appropriate place at all times (as outlined in the TMP and Traffic Control Plan) and that the TMP strategies are effective in serving their purpose. TMP should be updated as adjustments are required, based on observations during monitoring.

Guidelines for inspection and monitoring can be found in [Section 4](#).

## 3

## Temporary Work Zone Design

Section 3 outlines the fundamental principles of work zone design, explains terminology for defining the section of highway and temporary configuration, and outlines work zone design considerations for highway users. Information contained in this section is intended to assist the reader in understanding the guidelines presented in OTM Book 7 and evaluating situations that are either not explicitly demonstrated in the layouts or require sound engineering judgement. Definitions provided will be of interest to users who are required to either modify a layout or develop a new layout for a unique situation.

The following components of temporary work zone design are discussed in Section 3:

1. Fundamental principles.
2. Defining the highway environment.
3. Configurations for temporary conditions.
4. Component areas for temporary conditions.
5. Duration of work.
6. Speed management in temporary work zones.
7. Active road user considerations.
8. Visibility considerations.

### 3.1 Fundamental Principles of Work Zone Design

Risk to highway users, (motorists, pedestrians, cyclists, and others) and workers can be reduced by providing a predictable and intuitive highway environment. Consistent and appropriate application of traffic control devices throughout work zones increases the probability of users exhibiting desired behaviours.

As discussed in [Section 2.1](#), highway work zones should be designed around the following basic principles:

1. Worker safety.
2. Highway user safety.
3. Mobility and accessibility.
4. Communication and positive guidance.
5. Consistency and uniformity.
6. Constructability.

**NOTE**

Risk to highway users and workers can be reduced by providing a predictable and intuitive roadway environment.

These basic principles must be explicitly designed into construction, maintenance, or other projects on a public highway, rather than applied on a makeshift basis.

Workers in the work area are exposed to different hazards than workers installing and removing traffic control measures. Therefore, it is important that training be appropriate for the:

- Type of work being done.
- Level of exposure to traffic.
- Level of hazard the worker is exposed to.

**NOTE**

Traffic control installers do not have the ability to remove the hazard of the traffic they are exposed to and must be extremely aware of this issue.

For example, traffic control installers face different hazard levels on a 60 km/h highway than on a complex freeway and training should be completed in accordance with the maximum level of hazard.

Traffic control installers do not have the ability to remove the hazard of the traffic they are exposed to and must be extremely aware of this issue.

Users of OTM Book 7 should ensure that:

**1. Traffic movement is interfered with or inhibited as little as possible.**

- Frequent or unnecessary changes in highway configuration, such as sudden lane narrowing, lane closures, or reductions in speeds should be avoided.
- Precautions are taken to ensure that construction equipment can be safely operated without being hazardous to passing traffic.
- Highway occupancy and work completion time is minimized to reduce exposure to potential hazards.

**2. The public is informed of long duration operations.**

- Highway users are provided with current information on the existence of a work site, the reason behind the work, and the current status of the work.

**3. Adequate and consistent use of traffic control devices are provided.**

- Highway users are guided by appropriate combinations of:
  - Signs.
  - Channelizing devices.
  - Pavement markings.
  - Traffic signals.
  - Traffic Control Persons (TCP).

**NOTE**

On provincial highways, approval is required for the use of any traffic control device(s) not shown in OTM Book 7, including the use of non-standard combinations or configurations of otherwise standard devices.

#### 4. The plan for worker safety is communicated.

- Workers must understand the general principles of work zone safety.
- A Traffic Protection Plan (TPP) must be prepared in advance for any construction project, conforming with the policies and guidelines of the highway authority and Ministry of Labour, Trades and Skill Development (MLTSD) requirements.
- The TPP must be communicated to workers in a language they can understand.
- Workers must also be knowledgeable of general principles of work zone safety.

#### NOTE

A Traffic Protection Plan (TPP) must be prepared in advance for any construction project.

#### 5. Work Zone traffic controls are continually monitored and updated.

These practices help to ensure the credibility and reliability of the traffic control system, thus increasing the probability of driver compliance.

- Elements and devices that make up the traffic control system must be regularly monitored to ensure they remain in place, are undamaged and are visible as intended, and there are no obvious signs that motorists are having difficulty navigating the work zone.
- Traffic controls reflect actual conditions and are continually updated to suit changing conditions due to work staging and progress.
- All traffic control devices for temporary conditions are removed when no longer needed.
- When work is suspended for short periods of time, advance warning signs, and other inappropriate devices are removed, covered, or turned so they are not visible to highway users.
- Traffic control is monitored to ensure that there are no obvious signs that motorists are having difficulty navigating the work zone.

#### NOTE

All traffic control devices for temporary conditions must be removed when no longer needed.

## 3.2 Defining the Highway Environment

Application of the guidelines provided in Book 7 requires defining the highway environment affected by the temporary condition based on:

1. Area type.
2. Highway type.
3. Cross-Section.
4. Traffic Volume.

These elements are further described below.

### 3.2.1 Area Type (Urban or Rural)

The following table contains typical characteristics of urban and rural area types, challenges that may be encountered in these environments, and alternatives to consider in rectifying these challenges:

**Table 3.1 Urban and Rural Area Types**

	Area Type	
	Urban	Rural
<b>Typical characteristics:</b>	<ul style="list-style-type: none"> <li>• Limited maneuvering space.</li> <li>• Frequent turns and cross movements.</li> <li>• Need for pedestrian and cyclist protection.</li> <li>• Prevalence of street furniture and buildings.</li> <li>• Presence of curb and gutter.</li> <li>• Transit.</li> </ul>	<ul style="list-style-type: none"> <li>• Long trip distances.</li> <li>• Rare congestion.</li> <li>• Few alternate routes.</li> <li>• Sparsely spaced driveways and highway crossings.</li> <li>• Minimal development adjacent to the highway.</li> <li>• Primarily natural or agricultural environment.</li> <li>• Lacking curb and gutter.</li> </ul>
<b>Typical issues:</b>	<ul style="list-style-type: none"> <li>• Cluttering of signs.</li> <li>• Lack of shoulders and available space for placement of signs.</li> <li>• Non-compliance by highway users.</li> <li>• Short spacing between streets.</li> <li>• Addressing needs of multiple user types.</li> <li>• AODA requirements.</li> <li>• Multiple access (driveways, lane ways) and bus stops.</li> </ul>	<ul style="list-style-type: none"> <li>• Increased presence of wildlife.</li> <li>• Lack of illumination.</li> <li>• Higher vehicular speed.</li> <li>• Travelers may be unfamiliar with their surroundings.</li> <li>• Driver fatigue.</li> </ul>

	Area Type	
	Urban	Rural
<b>Alternatives to consider:</b>	<ul style="list-style-type: none"> <li>• On wide streets with high traffic speeds and volumes, use additional signs to attract motorist attention.</li> <li>• The required advance distances for the placement of warning signs, shown in OTM Book 7 layouts, must be adhered to as closely as practicable, but may have to be reduced where there are frequent driveways and short block lengths.</li> <li>• Consider using active control devices such as flashing arrow boards and variable message signs if the required advanced distances for warning sign placement cannot be satisfied.</li> <li>• If recommended taper length cannot be satisfied due to multiple entrance driveways, use additional traffic control devices, such as TC-12 flashing arrow board or reduced barrel spacing.</li> <li>• Where there are high volumes and expected long delays, install additional notification signs prior to work commencement.</li> <li>• If visibility is limited by the highway geometry or other obstacles, provide additional signs and extend the taper lengths shown in Book 7 layouts.</li> </ul>	<ul style="list-style-type: none"> <li>• If the temporary condition causes a queue, use additional signs in advance of queue to warn motorists and consider any limited visibility due to the highway geometry.</li> <li>• Wear highly reflective apparel such as fluorescent vests or overalls.</li> <li>• Use enhanced lighting on TC-22 to increase visibility.</li> <li>• Use of more active traffic control devices.</li> <li>• Use operating speed instead of normal posted regulatory speed (NPRS) as the criteria for traffic control layout.</li> </ul>

### 3.2.2 Highway Type (Freeway or Non-Freeway)

The following table contains criteria that define freeway and non-freeway highway types.

**Table 3.2 Freeway and Non-Freeway Highway Types**

Highway Type	
Freeway	Non-Freeway
<ul style="list-style-type: none"> <li>• A highway having all of the following criteria:               <ul style="list-style-type: none"> <li>○ A multi-lane, divided highway with more than four (4) through lanes total [two (2) through lanes in each direction] with a continuous dividing median.</li> <li>○ Full controlled access road limited to through traffic, with access through interchanges.</li> <li>○ A normal posted regulatory speed (NPRS) of 90 km/h or greater.</li> </ul> </li> <li>• All 400-series divided highways and toll highways built to freeway configuration.</li> <li>• All freeway speed transition zones where the speed limit has been reduced approaching the end of the freeway, and other areas where speed reductions are in place due to geometrics such as curves or freeway to freeway ramps.</li> </ul>	<ul style="list-style-type: none"> <li>• Any section of highway not matching the criteria of freeway.</li> </ul>

#### NOTE

For the purposes of traffic control, road authorities may designate some high volume and/or high-speed non-freeways as freeways.

### 3.2.3 Cross-Section (Two-Lane, Multi-Lane Divided or Undivided)

The following table contains criteria that define two-lane and multi-lane (divided and undivided) cross-sections.

**Table 3.3 Cross-Section Types**

Cross-Section Type		
Two-Lane	Multi-Lane	
Highways with a single lane dedicated to each direction in two-way traffic.	Highways with more than one lane dedicated to each direction in two-way traffic.	
	Divided	Undivided
	Physically divide the two-way traffic with dirt, grass, or raised medians.	Does not physically divide the two-way traffic. The two opposing directions are delineated with yellow pavement markings.

### 3.2.4 Traffic Volume (Low Volume or High Volume)

Traffic volume assessments should be conducted and include:

- Volume variation with time of day.
- Consideration to the impact to traffic control requirements.

Criteria that define low volume vs. high volume traffic are included in the following table:

**Table 3.4 Traffic Volume**

Traffic Volume	
Low Volume	High Volume
<ul style="list-style-type: none"> <li>• For temporary conditions, low volume highways are defined as those with a combined traffic volume in both directions of less than 3,000 vehicles per day.</li> <li>• Low volume highways often experience higher observed speeds.</li> </ul>	<ul style="list-style-type: none"> <li>• High volume highways are those with a combined traffic volume of 3,000 vehicles per day or more.</li> <li>• High volume highways require greater traffic flow control.</li> </ul>

## 3.3 Configurations for Temporary Conditions

Configurations for temporary conditions include varying degrees of complexity and levels of intrusion, and can be categorized as:

1. Off-shoulder.
2. Shoulder.
3. Lane encroachment.
4. Partial lane shift(s).



5. Lane closure(s) or lane occupied.
6. Detour.
7. Rolling closure.

These configurations are further defined below.

### 3.3.1 Off-Shoulder

---

Off-Shoulder work is defined as:

- Work within the right-of-way, but completely beyond the shoulder of the highway, such that workers, equipment, or vehicles (including parked vehicles) do not encroach onto the shoulder.
- Where a shoulder is not clearly defined, the work can be considered off-shoulder if the work area, including all work vehicles and equipment, is beyond 3.0 metres from the edge of the travelled portion of the highway.
- Work that requires no traffic control devices, but TC-2A or TC-2B should be used to notify drivers that there is work.

On provincial highways, off-shoulder work should comply with the Roadside Design Manual.

### 3.3.2 Shoulder

---

Shoulder is defined as:

- That portion of the highway between the edge of the travelled portion of the highway and the curb or point of intersection of the slope lines at the outer edge of a highway and the fill, ditch, or median slope, for the accommodation of:
  - Stopped vehicles, emergency vehicles, and for lateral support.
  - Workers, vehicles, equipment, and traffic control devices which remain on the shoulder and do not encroach into the travelled lanes.

Examples of layouts for reference purposes: [TS-5](#), [US-5](#), [DS-5](#), [FS-1](#), [FS-2](#).

### 3.3.3 Lane Encroachment

---

Lane encroachment refers to a configuration where:

- Workers, vehicles, or equipment are partially within the travelled lane, but there is at least 3.0 metres (3.5 metres for freeways) in width of useable lane for traffic.

#### NOTE

Lane encroachment is not recommended on freeways.

- Except where required for some maintenance mobile operations, lane encroachment is not recommended on freeways.

Examples of layouts for reference purposes: [TS-6](#), [TS-7](#), [US-7](#), [DS-7](#).

### 3.3.4 Partial Lane Shift(s)

A Partial Lane Shift is a configuration where:

- More than one lane is temporarily realigned and is used when:
  - Encroachment of highway operations will result in a traffic lane width of less than 3.0 metres. However, squeezing all lanes minimally will provide lane widths that are at least 3.0 m for each lane.

Lane shifts are generally less than 1.0 metre, however:

- Lane shifts greater than 1.0 metre on a typical two-lane highway occur only rarely, as this would create lane widths of less than 3.0 metres, in which case a lane closure must be used.
- Lane shifts greater than 1.0 metre can occur on two-lane highways with parking spaces on one or both sides with parking temporarily removed and parking area occupied by the shifted lane.

**NOTE**  
 Partial lane shifts must not be used where NPRS is 90 km/h or higher. Narrowed lanes are used for multi-lane roads where NPRS is higher than 80 km/h. Partial lane shifts can avoid the use of TCP(s).

Lane shifts avoid the closure of one lane and can avoid the use of a TCP(s), however, additional precautions must be given to worker safety during set-up and take down of traffic control devices.

The following table contains situations where partial lane shifts may be used:

**Table 3.5 Situations to Apply Partial Lane Shift**

Partial Lane Shift Situation	Comments
1. For short work areas (up to 50 metres) where visibility is good.	
2. On two-lane highways where NPRS is: <ul style="list-style-type: none"> <li>a) 60 km/h or lower (low- and high-volume highways).</li> <li>b) 70 km/h or higher (low-volume highways only).</li> </ul>	<ul style="list-style-type: none"> <li>• Partial lane shifts must not be used where normal posted regulatory speed is 90 km/h or higher.</li> </ul>

Partial Lane Shift Situation	Comments
<p>3. On multi-lane highways where NPRS is 90 km/h or higher, lane shifting is achieved using narrowed lanes.</p>	<ul style="list-style-type: none"> <li>• Lane widths should be at least 3.5 m for freeways.</li> <li>• Lanes must not be demarcated by only cones, but achieved using one or more of the following:                             <ul style="list-style-type: none"> <li>○ Temporary Construction Barrier System (TCBS) to provide work area protection;</li> <li>○ Construction markers or barrels for tapers; and/or,</li> <li>○ Temporary pavement markings for lane demarcation, along with removal of existing pavement markings.</li> </ul> </li> </ul>
	<ul style="list-style-type: none"> <li>• Higher speeds require more advance notice and a more gradual transition, with an appropriate taper length in advance of the lane shift.</li> </ul>
<b>Highway Surface:</b>	
<p>a) Within the hard surface of a highway.</p>	<ul style="list-style-type: none"> <li>• Typically, the best scenario for partial lane shifting.</li> </ul>
<p>b) Within the gravel shoulder of a highway.</p>	<ul style="list-style-type: none"> <li>• Posted speed reduction is required.</li> </ul>
<p>c) Within an all-gravel highway surface.</p>	<ul style="list-style-type: none"> <li>• Vehicles should not be directed off the highway onto a shoulder that is soft or has a different texture.</li> <li>• Abilities of vulnerable highway users such as motorcycles, cyclists, and pedestrians should be considered when a lane is shifted onto an unpaved surface.</li> </ul>

Examples of layouts for reference purposes: [TS-8](#), [TS-9](#), [US-10](#), [DS-10](#).

### 3.3.5 Lane Closure(s) or Lane Occupied

Lane Closure(s) or Lane Occupied are configurations where travelled lane(s) are closed off and traffic is redirected, and are used when:

- Highway operations result in lane widths of less than 3.0 metres (3.5 metres for freeways).
- Operations occupy a travelled lane.

Examples of layouts for reference purposes: [TS-12](#), [US-13](#), [DS-13](#), [FS-6](#).

### 3.3.6 Detours

A detour configuration occurs when traffic cannot be adequately accommodated within an existing highway and must be diverted from its normal path.

Guidance of traffic through detours requires signage that is continuous and complete to guide drivers back to the normal route.

Types of detours include:

1. **Highway Diversion** – traffic in both directions is required to make a short diversion, within the highway right-of-way, to bypass the work area.
2. **Lane Realignment** – traffic in one direction is diverted from its normal path onto an alternate alignment around a temporary work area.
3. **Route Detour** – Traffic is required to completely depart from the normal route and directed to use alternate roads. A route detour typically occurs when:
  - a) The road capacity is reduced to the point where some of the traffic must be redirected due to excessive delays.
  - b) The highway is entirely closed requiring an alternate route. The alternate route will be signed using a combination of appropriate TC-10 directional signs.

#### NOTE

Guidance of traffic through detours requires signage that is continuous and complete.

Except in an emergency, prior to the closing of a provincial highway and the opening of a route detour, the following steps should be taken:

1. Assess detour to ensure trucks can navigate through the route.
2. Check with municipal by-laws to ensure trucks can be accommodated through route.
3. A pre-construction planning meeting should be held with the representatives of the road authority, police, EMS, and fire departments as well as any affected transit authority to advise them of the situation and allow them to assess how this will affect their functions and responsibilities.
4. Involving a neighbouring municipality or different level of government may be necessary when their highway(s) intersect or are significantly affected by the route detour.
5. Information regarding the closing may be posted on the road authority's website and/or given to media outlets and local newspapers, in accordance with road authority policy.

#### NOTE

Where detours are to be used, a pre-construction planning meeting should be held with representatives of the road authority, police, EMS, fire department, and transit authority.

6. Notices may also be distributed to affected households and businesses to advise them of the upcoming disruption in their area.
7. A highway closing information sign must be erected at strategically selected locations of the highway at least one week in advance of the actual closing.
8. Construction ahead signs must be installed when work first commences and the detour signs must not be exposed to view until the detour is required.
9. Before a route or a temporary detour is opened to the public, all signs pertinent to the condition must be installed in their proper positions.

On some highways, particularly on freeways, it may be preferable to close specific sections (such as longitudinal sections or one of the highways in an express/collector configuration) without providing specific route detours. In this case:

- Drivers, usually commuters who are familiar with the highway network, can make their own decisions on alternate routes.
- Advisory signage of highway closures may be provided with either static signs or Portable Variable Message Signs (PVMS). Information provided on the signage would include:
  - Highway section being closed.
  - Hours being closed.
  - Period of closure (start and finish dates).
  - To avoid information overload for drivers, it may be necessary to provide information on successive signs (or PVMS) in phases, rather than on a single sign or sign display.
  - Signage should be designed in accordance with the sign design principles provided in OTM Book 2.

**NOTE**

Before a route or a temporary detour is opened, all pertinent signs must be installed in their proper positions.

Examples of layouts for reference purposes: [TS-21](#), [TS-22](#), [TI-14](#), [TI-15](#), [UI-25](#), [UI-26](#), [DI-25](#), [DI-26](#).

### 3.3.7 Rolling Closures

During rolling closures, lead vehicles such as police car(s), Crash Truck(s), and/or sign truck(s), are used to control the speed and restrain vehicles upstream of a construction site, so as to create a time window (usually 5 to 15 minutes) when the highway downstream is effectively clear of vehicles.

This creates an unhindered opportunity for workers to do work and/or make traffic control changes at the work site while clear of live traffic.

Situations where rolling closures may be a good method of traffic control are Intermittent Duration (ID) operations where traffic can safely and efficiently be prevented temporarily from entering the work

zone. Examples include:

- Changing a lane closure on a freeway from a right lane closure to a left lane closure, or vice versa.
- Installing or removing an overhead sign structure.

**NOTE**

Use of paid duty police officers is required for rolling closures on freeways.

It is the decision of the road authority to use rolling closures. Paid duty police officers are required for freeway rolling closures due to increased hazard levels.

Refer to [Section 4.4.4](#) for traffic control using moving vehicles.

## 3.4 Component Areas for Temporary Conditions

A construction zone encompasses the full length of a project. Within a construction zone:

- There may be one or more work zones.
- The road authority may legally establish speed fines which are doubled when workers are present.

A work zone is an area where traffic control devices have been set up to provide positive guidance to highway users through a temporary situation and include the entire section from the first advance warning sign through to the last traffic control device, where traffic returns to its normal path and conditions.

A work zone can be in any of the configurations described in [Section 3.3](#). They may be stationary or mobile and should use up as little street space as possible.

A well-designed work zone normally contains six distinct component areas in the following sequence, and further described in the Sections below:

1. Advance warning area.
2. Approach area.
3. Transition area.
4. Longitudinal buffer area.
5. Work area.
6. Termination area.

**NOTE**

A well-designed work zone normally contains six distinct component areas.

[Figure 3.1](#), below, shows Component Areas for Construction Zones and Work Zones.

Figure 3.1 Component Areas

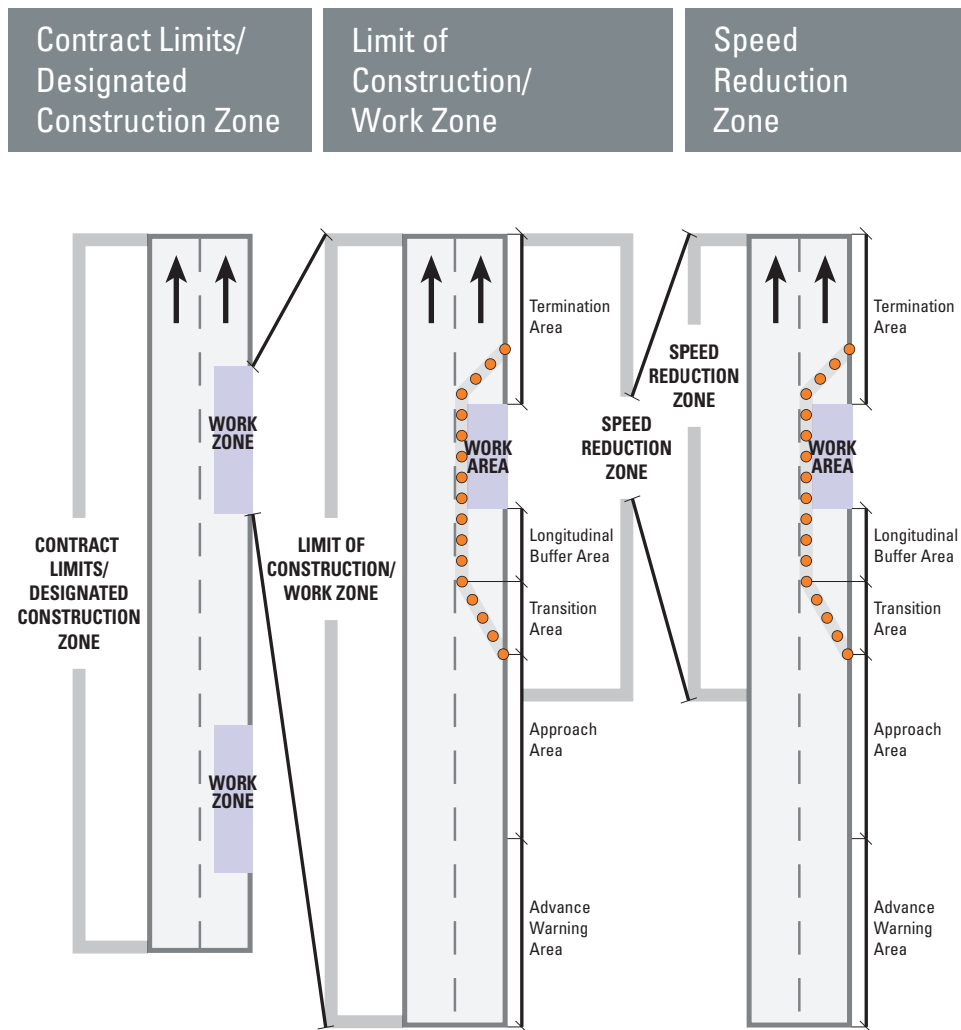

See: [TG-2](#), [UG-2](#), [DG-2](#), [FG-2](#) and [Section 3.6](#) for designated construction zone signage.

### 3.4.1 Advance Warning Area

The advance warning area alerts highway users of highway work ahead and should be actively monitored. If queues extend beyond advance warning signs, additional traffic control devices should be set up in advance of the anticipated and/or observed end of a queue.

The advance warning area may need to be increased to accommodate obstacles such as:

- Interchanges.
- Bridges.
- Sightline restrictions.

Required distances for the placement of advance warning area signs, shown in [Section 6](#) (Layouts), must be adhered to as closely as practicable.

### 3.4.2 Approach Area

The approach area is used to inform highway users of actions that are required or prohibited such as:

- Lane changes.
- Speed reductions.
- Passing restrictions, etc.

Highway users require this information at a sufficient distance in advance, to be able to adjust to the altered situation before reaching it. Approach area devices may vary from a single sign or flashing lights, to a series of signs in advance of the transition area.

Required distances for the placement of approach area devices, shown in [Section 6](#) (Layouts), must be adhered to as closely as practicable.

### 3.4.3 Transition Area

The transition area channels traffic from the normal path to a new path required to move traffic past the work area. Work material, vehicles, and equipment must not be stored or parked in transition areas.

Transition areas must be:

- Obvious to highway users, with intended travel path clearly delineated so they do not mistakenly follow the wrong path.
- Delineated by channelizing devices unless otherwise indicated in the layouts.
- Composed of tapers and parallel sections (if more than one lane is closed) to effectively close the lanes.

#### NOTE

Transition areas must be obvious to highway users

Parallel sections, referenced above, are the lengths between successive tapers and are not the same as Longitudinal Buffer Areas (LBA) described in the next section.

#### **Delineating the Transition Taper**

One of the most important elements in the layout of traffic control devices is the transition taper for full lane closure or other reductions in pavement width. Guidelines for delineating the transition taper follows:



- When used for channelizing in a transition taper, devices should provide a smooth and gradual transition that is constant and easily interpreted.
- An inadequate taper is likely to produce undesirable traffic operations with resulting congestion and the possibility of collisions through the work zone or encroachment into the work area.
- Vehicles and equipment must not be kept in the taper area, except for TC-12 Flashing Arrow Boards.
- The minimum desirable taper length for various approach speeds and device spacing is provided in [Table A](#), [Table B](#), and [Table C](#) in [Section 6](#). These tables also provide guidance as to speed-related distances and spacing relationships for the placement of general warning signs, and other guidance and information devices.

**NOTE**

When used for channelizing in a transition taper, devices should provide a smooth and gradual transition.

If visibility is limited by a horizontal or vertical curve, a taper might need to be lengthened (beyond the length shown in layouts) to give drivers adequate warning and visibility of the start of the taper.

For long duration operations, there may be a requirement to remove or mask existing pavement markings and enhance the transition area with temporary pavement markings to identify a clear route, where there could be confusion about the proper path.

### 3.4.4 Longitudinal Buffer Areas (LBA)

An LBA is an empty space between the end of the transition area and the work area or Buffer Vehicle (BV) that out of control vehicles can use to brake to a full stop.

LBA provides protection for traffic and workers, by providing an opportunity for highway users to brake to a halt.

Traffic control devices, work material, vehicles, and equipment must not be stored or parked in an LBA.

When an LBA is used with a BV, the appropriate distance to use in front (downstream) of the BV is called the Lateral Intrusion Deterrence Gap (LIDG). The LIDG is used in combination with the taper, LBA, and BV (see [Section 4.5](#)).

An LBA is recommended in all situations where practicable and may be used in circumstances not indicated in the layouts. As a guideline, LBA is not required:

- For partial lane shifts, provided lane widths of at least 3.0 metres are maintained.
- For non-freeway shoulder operations.

**NOTE**

Traffic control devices, work material, vehicles, and equipment must not be stored or parked in an LBA.

- Where traffic is controlled using TCP, Automated Flagger Assistance Devices (AFAD), Portable Lane Control Signals (PLCS), or Portable Temporary Traffic Signals (PTTS).
- In urban areas where normal posted speeds are 60 km/h or lower.
- Drivers face more stimuli, including traffic signals, and are less likely to be drowsy or inattentive. Other traffic control devices in the work zone should be sufficient to alert drivers of the work area ahead, without requiring an LBA.

LBA lengths are included in [Table A](#), [Table B](#), [Table C](#), and [Table D](#) and illustrated on the layouts, where applicable.

For more information on LBA, refer to O. Reg. 213/91, s. 67.

### 3.4.5 Work Area

---

The work area is an area where the work takes place and/or equipment and material are stored. The work area:

- May or may not contain a work vehicle.
- May be in a fixed location or move as work progresses.
- May be more than one work area within a work zone.

It is still considered a work area when work has temporarily stopped yet the highway has not returned to its normal operation conditions.

Every effort should be made to minimize hazards and distractions to drivers and workers. See the requirements of Regulation 213/91 under the OHSA.

### 3.4.6 Termination Area

---

The termination area is an area where traffic makes the transition back to the normal path of a highway. They extend from the downstream end of the work area to the point where traffic is able to resume normal driving, typically at the end of the delineation of the termination taper on multi-lane divided highways, or at the TC-2 in the opposing direction of an undivided highway.

### 3.4.7 Additional Considerations in Component Area Design

---

#### 3.4.7.1 Ingress and Egress

Ingress to, and egress from, the work zone should be set up to ensure safety of workers and highway users and have minimal impact on traffic flow.

The following considerations should be made **during design**:

- Ensure sufficient gaps are available in the traffic flow for ingress and egress of work vehicles.
- Coordination of deliveries (i.e., arranging deliveries for off-peak hours if congestion is an issue).
- Provide adequate deceleration/acceleration lanes for work vehicles that are entering/exiting the travelled lane, and ensuring they are free of obstructions and/or workers.
- Maintain driver expectancy by:
  - Providing sufficient direction to motorists.
  - Allowing for adequate sight distances, accounting for curves and obstructions.
  - Including sufficient traffic control devices and lighting, so that drivers will not follow vehicles into the work area.

The following considerations should be made **during construction**:

- Using a TCP to control work vehicles entering/exiting the work area.
  - A TCP may stop public traffic and/or work vehicles to protect work vehicles crossing or entering a highway where the NPRS is less than or equal to 60 km/hr.
  - Where the NPRS is greater than 60 km/h, TCP may control work vehicles entering/crossing only, not public traffic.
- Widening the spacing between markers in the termination area or extend across only one lane (in the termination of a multiple lane closure) so that ingress/egress of work vehicles will not be hindered.
- Ensuring the following:
  - All equipment, vehicles, and employee parking remain clear of areas where trucks need to enter or exit the work zone.
  - Openings that are not in use are closed off.
  - Channelizing devices are regularly checked, and traffic observed for indications of confusion.
  - Dynamic signs approved by the road authority are being used.

### 3.4.7.2 Linear Space Restrictions

There may be situations where, due to linear space restrictions, the recommended lengths for the component areas cannot be achieved as shown in the layouts. However, linear space restrictions

do not justify any failure to use enough warning and channelizing devices as required for public protection and guidance, or for protection of workers.

**In urban low speed areas**, characterized by closely spaced intersections and/or many driveways and entrances within the available linear space, the following modifications may be considered:

- Reducing taper lengths to the minimum shown below in [Table 3.6](#).

**Table 3.6 Linear Space Restrictions in Urban Non-freeway Areas**

Urban Non-freeway with Linear Space Restrictions	Normal Posted Regulatory Speed (NPRS) Limit		
	50 km/h	60 km/h	70 km/h
Taper Length for Full Lane Closure (m)	30	40	60

- Shortening or eliminating the termination area.
- Reducing the advance warning area. All advance signs must be placed ahead of the approach area.
- Relocating the taper and buffer areas upstream of the intervening obstruction.
- Reducing or eliminating the LBA. The LBA length is derived such that the taper plus the LBA length are greater than the stopping sight distance. In such cases, additional advance warning and delineation devices should be considered. Reducing or eliminating an LBA should only be undertaken once alternatives, such as relocating the taper and buffer areas upstream of the intervening restriction, have been considered and deemed impractical. Section 3.4.4 describes conditions under which an LBA is not required.
- In situations where, even with the elimination of the LBA, it is necessary to reduce taper lengths in the transition area, additional traffic control devices, such as a TC-12 flashing arrow board or reduced barrel spacing should be used.

**On rural low volume highways**, where low volume is defined as less than 3,000 vehicles/day total in both directions, the minimum taper length for highway closures may be reduced as shown below in [Table 3.7](#).

**NOTE**  
 Volumes may be obtained from the road authority. Alternatively, a count can be taken of vehicles traveling in both directions during a 3-minute period. Less than 10 vehicles correspond to less than 3,000 vehicles/day.

**Table 3.7 Linear Space Restrictions in Rural Non-freeway Areas**

Rural Non-freeway with Low Traffic Volumes	Normal Posted Regulatory Speed (NPRS) Limit		
	70 km/h	80 km/h	90 km/h
Taper Length for Full Lane Closure (m)	60	100	140

On freeways, where a Crash Truck (CT) is required, linear space restrictions are less likely to arise. Where they may arise, however, is when working in the vicinity of interchange ramps. In this case, consideration should be given to:

- Lengthening the taper and/or LBA.
- Bringing the start of the taper further upstream.
- Closing the interchange ramps.

If these options are not feasible, and some reduction in linear dimension cannot be avoided, the LBA should be reduced in conjunction with a reduction in the length of the taper. In this case:

- Additional active advance warning devices must be used.
- The LIDG between the Crash Truck and the work area should not be reduced.
- The taper should not be reduced by more than 50% of its normal length (see [Table C](#)).

Under such conditions, the use of a CT or other protection/attenuation device along with additional advance warning and guidance devices, must be in accordance with the guidelines outlined in [Section 4](#).

### 3.4.7.3 Horizontal and Vertical Clearance

Workers and/or equipment must not be positioned on the outboard side of cones or delineators. Consideration must be given to:

- Providing sufficient horizontal clearance within the delineation of the work area to contain all work and/or equipment on or above ground, including elevated equipment such as bucket trucks used for work under bridge structures and overhead wires.
- Height variances across the lane/shoulders and the effect of super-elevation on tall vehicles (i.e., tractor trailers) on the travelled lane through the work zone.

## 3.5 Duration of Work

Duration of work is a major factor in determining the number and types of signs and devices, and the way they are used, in temporary work zones. The five categories of work duration used in Book 7 are:

1. Mobile Operations.
2. Intermittent Duration (ID).
3. Very Short Duration (VSD).
4. Short Duration (SD).
5. Long Duration (LD).

Categories 2 to 5 are used for stationary operations.

Required component lengths and device spacing are treated differently for non-freeways and freeways as there is a greater expectation by drivers for smooth, uninterrupted traffic flow on freeways.

[Table A](#), [Table B](#), and [Table C](#) in [Section 6](#) provide appropriate distances and are laid out as follows:

- Table A: Non-Freeways (Mobile, ID, and VSD work).
- Table B: Non-Freeways (SD and LD work).
- Table C: Freeways (Mobile, ID, VSD, SD, and LD work).

### 3.5.1 Mobile Operations

**Definition:**

Mobile operations involve work that is done while continuously moving, usually at low speeds (typically 5 to 30 km/h).

Mobile operations may have:

- Periodic brief stops, related to the mobile activity.
- Stops do not exceed a few minutes in duration.
- No planned work to take place outside the work vehicle.

**NOTE**

Mobile Operations involve work that is done while continuously moving, usually at low speeds.

If a brief stop is required at a predetermined specific location, it is considered ID or VSD work rather than a mobile operation.

During mobile operations, the advanced warning area moves with the activity area.

**Devices Required:**

Where volume is light, and visibility is good:

- A well-marked, well-signed vehicle may be enough.

Where volume and/or speeds are higher:

- A BV equipped with a flashing arrow board should follow the work vehicle.

- Work vehicles must have at minimum, four-way flashers and an amber 360-degree beacon device (4WF/360°). A 360-degree beacon directs intense light continuously through all 360 degrees of the compass and must complete a full rotation every 1.5 seconds. Alternatively, rotating LED amber lights can be used in place of 4WF plus 360-degree beacon device.
- The vehicles may also be equipped with truck-mounted attenuators, and appropriate signs, as illustrated in the layouts.

Where mobile operations occur in a travelled lane of a multi-lane divided high-speed highway (NPRS 70 km/h or greater), flashing arrow boards must be used.

**Examples:**

Examples of mobile operations include:

- Zone painting.
- Street sweeping.
- Longitudinal pavement marking.

Paving operations are a very low speed type of mobile operation; so low that layouts are those used for stationary operations. Specific requirements for paving operations are described in [Section 4](#).

### 3.5.2 Intermittent Duration Work (ID)

**Definition:**

ID work occupies a fixed location for 15 minutes or less, including the time it takes to set up and remove traffic control devices.

- The work site may be moved along the highway and make frequent and short stops where planned work takes place outside of the work vehicle.
- If a short stop of less than 15 minutes is required at a specific location, it is ID work rather than a Mobile Operation.
- If a worker is to be exposed to traffic for more than 15 minutes, including the time required to set up traffic control devices and work time, then a greater protection is required and traffic control layouts for VSD work should be used.

**Devices Required:**

Active devices, such as flashing arrow boards and simplified setup and removal procedures are recommended for ID work, which help to ensure:

- Adequate traffic control.
- Reduction in the time that the worker is exposed to traffic hazards.

**NOTE**

Intermittent duration work occupies a fixed location for 15 minutes or less.

- More efficient and productive work operations.

**Examples:**

Examples of ID work include:

- Pothole patching.
- Surveying.
- Dead animal removal.
- Minor debris pickup.

### 3.5.3 Very Short Duration Work (VSD)

**Definition:**

VSD work occupies a fixed location for 30 minutes or less, but more than 15 minutes including the time it takes to set up and remove traffic control devices. The work site may be moved along the highway and make frequent and short stops where planned work takes place outside of the work vehicle. If a short stop is required at a specific location, it is VSD work rather than a Mobile Operation. If a worker is to be exposed to traffic for more than 30 minutes, including the time required to set up traffic control devices and work time, then a greater protection is required and traffic control layouts for SD work should be used.

**Devices:**

Active devices such as flashing arrow boards, simplified set up and removal procedures, and rolling closures are recommended for VSD work and help to ensure:

- Adequate traffic control.
- Reduction in the time that the worker is exposed to traffic hazards.
- More efficient and productive work operations.

**NOTE**

Very short duration work occupies a fixed location for 30 minutes or less.

**Examples:**

Examples of VSD work include:

- Some utility works.
- Minor highway maintenance.
- Pothole patching.
- Surveying.
- Stormwater catch basin cleanout.



### 3.5.4 Short Duration Work (SD)

**Definition:**

SD work refers to activities that require work areas that are continuously occupied by workers and/or equipment for more than 30 minutes but less than one 24-hour period in duration. SD work does not generally include work at a site that extends beyond 24 hours; such work is LD. However, work at the same location may extend over more than one day, and still be considered SD work for the purpose of traffic control device layout, if all of the following conditions are met:

1. The approval of the road authority is obtained. The road authority may consider that LD work is more appropriate for recurring lane closures.
2. Any additional conditions stipulated by the road authority, including working hours, are complied with.
3. Continuous work is less than 24 hours.
4. The highway (and sidewalk) are restored to the satisfaction of the road authority and returned to normal operation when the daily work shift (or authorized working period) is complete.

**NOTE**

Short duration work occupies a fixed location for more than 30 minutes but less than 24 hours.

### 3.5.5 Long Duration Work (LD)

**Definition:**

LD work refers to activities which require a work area for longer than 24 hours. Longer exposure of workers and highway users requires more positive guidance through a temporary condition.

**Devices:**

Temporary highways and barriers may be provided, and inappropriate markings which cause driver confusion should be removed and replaced with temporary markings.

For stationary operations on freeways longer than five days in duration, temporary construction barrier systems (TCBS) are required, as required by Ontario Regulation 213/91, Section 67 under the OSHA. For minimal working widths, TCBS either do not deflect or have minimal deflection. TCBS are designed and crash tested for placement on paved surfaces.

**NOTE**

Long duration work occupies a fixed location for more than 24 hours.

## 3.6 Speed Management in Temporary Work Zones

Managing compliance with NPRS, or reduced speed limits within a work zone is necessary for both highway user and worker safety.

Measures that may be considered to be effective in helping to manage speeds and increase compliance with posted speeds in work zones include:

1. **Police presence** with enforcement in the work zone.
  - Most effective.
  - Provisions should be made to assist police to find a location to set up for enforcement in the constrained confines of a construction site.
2. **Establishing a designated construction zone** to double the speed fines when workers are present.
  - The effect of this measure is enhanced with the presence of police and enforcement.
3. **Use of active devices** to encourage compliance.
  - Variable Message Signs (VMS) can be used to inform users of temporary conditions ahead that require them to slow down.
  - Speed display signs, where the speed of drivers is measured by radar and displayed to the driver on a VMS can be installed.
  - When drivers see their speeds displayed:
    - Some may be genuinely surprised that they are travelling that fast and may reduce their speeds.
    - Other drivers may be uncertain as to whether a sign that shows their speed means that enforcement is nearby and may reduce speed to avoid a potential fine.
  - The effect of a single VMS in a long work zone may be reduced with distance from the sign; therefore, multiple VMS may be required to sustain a speed reduction.
  - This measure will have lasting effectiveness only if supported by periodic police enforcement.
  - Refer to OTM Book 10 (Dynamic Message Signs) for guidelines on the safe placement of VMS and manufacturer guidelines to ensure accurate readings.
  - VMS should not be used for one lane of a multi-lane highway as there is the potential for increased speed variance.
  - Road authority approval and enforcement consultation should be obtained prior to the use of speed display signs.

### NOTE

Speed display VMS should not be used for one lane of a multi-lane highway.

4. **Use of pilot vehicles, pace vehicles or rolling closures.**

- See [Section 4](#) for speed reductions for specific periods of time or specific work operations.

5. **Posting of reduced speed limits** through either:



- Installation of advisory speed limit signs (orange and black, non-enforceable) together with narrower highways or lanes through the work area; or
- Installation of regulatory speed limit signs (black and white, requires establishing a designated construction zone).

**Table 3.8 provides speed management methods and devices, including their potential effectiveness at reducing operating speeds and increasing driver alertness.**

**Table 3.8 Potential Effectiveness of Speed Management Methods**

Speed Management Method/Device		Potential Effectiveness at:	
		Reducing Operating Speeds	Increasing Driver Alertness
Speed Limit Reduction	Regulatory speed reduction, no enforcement		
	Regulatory speed reduction, periodic enforcement		
	Regulatory speed reduction, constant police presence		
	Advisory speed reduction		
With or Without Speed Limit Reduction	Police presence		
	Lane narrowing using channelization devices		
	PVMS		
	Speed radar and display		
	Temporary rumble strips		
	Pilot vehicles		
	Pace vehicles		

**Legend**

	Most effective
	Shown to be reasonably effective
	Shown to have little effect

### 3.6.1 Guidelines for Posting Reduced Speed Limits in Construction Zones

Highway work zones must be designed around the basic principles of:

1. Worker safety.
2. Highway user safety.
3. Highway user mobility.

Improving highway user safety also improves worker safety since traffic crashes often put workers at risk.

Research has shown that simply reducing the speed limit can negatively impact work zone safety by increasing speed differentials and crash risk. Therefore, the following guidelines should be followed:

- **A Traffic Management Plan (TMP) should be developed for each project in accordance with [Section 2](#).**

In developing the TMP, a comprehensive safety risk review should be conducted along with a hierarchical approach to work zone safety, starting with more conservative and effective measures than speed limit reduction. Greater separation of vehicles from workers, protective barriers or other risk reduction strategies should be implemented as part of the Traffic Management Plan.

- **The travelled way through a work zone should be designed for an operating speed that is equal to or as close as possible to the design speed of the approaches to the work zone.**

If a speed limit reduction is deemed necessary, road authorities have the option of using advisory signs or reducing the regulatory speed limit, either temporarily or continuously through a construction zone. [Table 3.9](#) provides examples of the appropriate uses of each method. Both regulatory and advisory speed limit signs can be used on different portions of the same contract for severe work zone conditions. The police and road authorities should discuss logistics of enforcement and speed control.

- **Regulatory and advisory speed reductions should not be more than 20 km/h below the normal posted speed.**

Speed limit reductions of 20 km/h or less have been shown to be more effective than larger reductions at minimizing speed variance and crash risk.

- **Speed reductions are more likely to be obeyed by motorists if they are perceived as necessary.**

The reason for the speed reduction should be provided through advance signage and repeated as necessary.

When reduced regulatory speed limits are used for temporary worker safety (as described in [Table 3.9](#)), signs must be covered or removed, and the NPRS must be restored when workers are not present. The speed reduction must move with the active operation and there must be visible signs of work activity.

- **Regulatory speed limit signs shall only be installed when approved by the road authority.**

Once approved, the appropriate police authority must be notified of the regulatory speed change prior to installation.

- **Regulatory speed reductions should be at least 300 metres in length, even if the work zone is less than 300 metres.**

Speed reductions can be implemented in stages. On a divided highway, the road authority may permit different speed limits for each direction of travel. In the case of an express/collector freeway, the speed limit may be lowered on one highway, but not on the other.

**NOTE**

Speed reductions are more likely to be obeyed by motorists if they are perceived as necessary. NPRS must be restored when workers are not present.

The following table presents the appropriate use of advisory or regulatory speed limit signage when posting reduced speed limits in construction zones.

**Table 3.9 Posting of Reduced Speed Limits in Construction Zones: Appropriate Use of Advisory or Regulatory Speed Limit Signs**

Method	Examples of where speed limit reductions should be considered:	Required Approval
Advisory Speed Limits: <ul style="list-style-type: none"> <li>• Used whenever an unexpected change in geometrics is caused by the work activity.</li> </ul>	<ul style="list-style-type: none"> <li>• Bumps.</li> <li>• Low shoulders.</li> <li>• Drop-offs.</li> <li>• Limited, but not substandard, sight lines or stopping sight distances.</li> <li>• Limited, but not substandard, horizontal or vertical alignment.</li> <li>• Gravel surfaces (less than 500 metres in length).</li> <li>• Temporary lane closures.</li> <li>• Milled surfaces.</li> </ul>	<ul style="list-style-type: none"> <li>• As required by the road authority.</li> <li>• For provincial highways, with agreement of the regional Traffic office.</li> </ul>



Method	Examples of where speed limit reductions should be considered:	Required Approval
<p>Regulatory Speed Limits:</p> <ul style="list-style-type: none"> <li>Used for temporary, worker safety; only to be used when workers present.</li> </ul>	<ul style="list-style-type: none"> <li>Where workers on a <b>freeway</b> are within 3.0 metres of a travelled lane that is open to traffic and where no barrier is used (see <a href="#">Section 4</a>).</li> <li>Where workers on a <b>non-freeway</b> with NPRS greater than or equal to 70 km/h are within 3.0 metres of a travelled lane that is open to traffic and where no barrier is used (see <a href="#">Section 4</a>).</li> <li>Where workers on a <b>non-freeway</b> with NPRS less than 70 km/h are within 1.5 metres of a travelled lane that is open to traffic where no barrier is used (see <a href="#">Section 4</a>).</li> </ul>	<ul style="list-style-type: none"> <li>Approval by the road authority is required.</li> <li>For provincial highways, approval by regional Traffic using:                             <ul style="list-style-type: none"> <li>Designation of Construction Zone form and Justification Report outlining the rationale for the speed reduction; or,</li> </ul> </li> <li>As per Special Provisions in the contract.</li> </ul>
<p>Regulatory Speed Limits:</p> <ul style="list-style-type: none"> <li>Used for continuous public and worker safety on Long Duration (LD) construction when workers are present 24 hours per day; or,</li> <li>Used for highway user safety due to continuous hazards, or where uninterrupted flow cannot be designed at or above the normal regulatory posted speed (substandard geometrics).</li> </ul>	<ul style="list-style-type: none"> <li>Where lane width is less than 3.5 metres on freeways or less than 3.0 metres on non-freeways.</li> <li>Where shoulder width or offset to barriers is less than 0.5 metres, on one or both sides.</li> <li>Where there is sudden lane narrowing.</li> <li>Where there are substandard sight lines or stopping sight distances.</li> </ul>	<ul style="list-style-type: none"> <li>Approval by the road authority is required.</li> <li>For provincial highways, approval by regional Traffic using:                             <ul style="list-style-type: none"> <li>Designation of Construction Zone form and Justification Report outlining the rationale for the speed reduction; or,</li> </ul> </li> <li>As per Special Provisions in the contract.</li> </ul>

Method	Examples of where speed limit reductions should be considered:	Required Approval
	<ul style="list-style-type: none"> <li>• Where there are multiple lane shifts, detours or transitions designed at less than the normal posted speed limit, or those with no illumination.</li> <li>• Where there is substandard horizontal or vertical alignment.</li> <li>• Where there are multiple lane shifts with overlapping/confusing pavement markings.</li> <li>• Where there are partial lane shifts onto a surface texture different from the main highway.</li> <li>• Gravel surfaces (greater than 500 metres in length).</li> </ul>	

### 3.6.2 Designating the Construction Zone

Designated construction zones are established by the road authority in order to:

- Reduce the regulatory speed limit.
- Enforce the legislation on doubled speed fines.

The road authority may delegate a senior staff member who will:

- Designate the construction zone.
- Set the speed limit.
- Ensure that records are kept with details on when a speed limit is changed.

#### NOTE

To reduce the regulatory speed limit or to enforce the legislation on doubled speed fines, the road authority must establish a designated construction zone.

Contractors do not have the authority to establish designated construction zones.

Only MTO can establish designated construction zones on provincial highways.

The Highway Traffic Act (HTA) requires that a designated construction zone must be clearly marked with standard:

- Rb-90A “CONSTRUCTION ZONE BEGINS” sign; and,
- Rb-90B “CONSTRUCTION ZONE ENDS” sign found in Regulation 615 of the Act, and in [Section 4](#).

Reduced speed limits become enforceable once the required signs are posted.

Limits of the designated construction zone should be selected such that there is enough room within the zone to accommodate all signs except for:

- TC-1, TC-1A, TC-1B, TC-5, TC-5A, TC-5B, and the information signs in advance of these.

See [TG-1](#), [TG-2](#), [UG-1](#), [UG-2](#), [DG-1](#), [DG-2](#), [FG-1](#), [FG-2](#) for designated construction zones and reduced speed limit signage.

Rules that govern speed limits in designated construction zones, and the doubling of speeding fines in a construction zone when workers are present are detailed in *Bill 169 of the Transportation Statute Law Amendment Act, 2005*, which received Royal Assent on November 21, 2005.

### 3.6.3 Turn Prohibitions and Other Regulations in the Construction Zone

Under some circumstances, it may be necessary to:

- Prohibit turns, especially left turns, in a construction zone that passes through a major intersection in order to maintain adequate traffic flow. The regulations may be part-time or full-time, depending on the nature of the traffic volume, and should be formal and enacted through the regulatory process, in order to be enforceable. Transit or other exceptions may be required.
- Ban parking that approaches a construction zone to ensure traffic control devices are visible and enough space is available for the transition area. Appropriate approvals must be obtained from the road authority.

For provincial highways, regional Traffic Office approval of the PHM-125 drawing is required for all temporary signals, including any revision to the PHM-125 drawing, prior to implementation. For any revision to permanent signals, provincial Traffic Office approval is required prior to implementation.

## 3.7 Active Road User Considerations

Safety of pedestrians, cyclists and other active road users **must** be addressed in all temporary traffic control layouts where they are, or may be, present. Temporary traffic control plans include



accommodation for active road users unless they are always expressly prohibited (i.e. on a freeway). Active road users should be considered for each construction phase.

### 3.7.1 Pedestrian Safety Considerations

Pedestrians should be provided with a safe, convenient, and clearly delineated travel path that ensures:

- Exposure to potential hazards is minimized.
- Pedestrians are not led into direct conflicts with:
  - Work site vehicles, equipment, or operations.
  - Mainline traffic that is moving through or around the work site.
- The characteristics of the existing sidewalk(s) or footpath(s) are replicated as closely as possible.
- Pedestrians are guided to, through, and from work sites in a clear and positive manner.
- Pedestrian movements are inhibited as little as possible.
- The pedestrian travel path and pedestrian traffic control are compliant with the Accessibility for Ontarians with Disabilities Act (AODA). For example:
  - A minimum sidewalk or path width of 1.8 m is preferred in areas where accessibility may become an issue for two wheelchairs passing one another.
  - The needs of visually impaired pedestrians shall also be considered, as a construction site can be challenging to safely and comfortably traverse.

#### NOTE

Temporary pedestrian accommodation must be compliant with the AODA.

Existing travel patterns should be observed and/or a meeting with the local community be held to determine the extent of accommodation required. Additional pedestrian accommodations are indicated with the presence of:

- Significant pedestrian generators (e.g. schools, community centers).
- A significant number of vulnerable pedestrians (seniors, children, disabled, etc.).
- Transit routes, stops, and intermodal transfer points.
- Well-traveled pedestrian routes (e.g. signed trails, links between pedestrian origins and destinations).

Pedestrian traffic control devices should be routinely inspected and are not to be used for the control or channelization of moving vehicular traffic.

### 3.7.1.1 Pedestrian Protection from the Work Zone

Pedestrians must be protected from all potential hazards associated with the work zone. These hazards and potential mitigations include:

- **Equipment and moving vehicles**
  - Place barricades to separate pedestrians from moving traffic and/or a work area, as described in [Section 4](#).
  - Use temporary construction barrier system (TCBS) where high speed or volumes of vehicles may present greater risk.
  - Do not use mesh fencing, caution tape, cones, or other materials which do not provide positive pedestrian protection.
  - Provide construction vehicle ingress/egress signs visible to pedestrians.
- **Trenches and excavations**
  - Use temporary construction barrier system (TCBS) to prevent pedestrians from falling into open excavations.
  - Do not use pedestrian barricades for excavations more than 2.4 m in depth.
  - Refer to O. Reg. 213/91 for more information on trenches and excavations requirements.
- **Tripping hazards from debris or uneven surfaces**
  - Provide night-time illumination where existing is not sufficient.
  - Avoid the use of material that may result in slippery walkway surfaces.
  - Regularly inspect path for debris and potential for tripping.
  - Provide curb ramps meeting AODA standards.
  - Where provided, railing should be sturdy, firm to grip, and smooth. Refer to O. Reg. 413/12 for more information on handrails.
- **Obstructions to their path**
  - Provide an obstruction-free path of consistent width wherever possible.
  - Clearly mark any obstructions, especially at night.
- **Overhead hazards such as falling material or overhead work**
  - Use covered walkways for work being carried out at 4.5 m or less from a public walkway.
  - Refer to O. Reg. 213/91 for more information on public way protection.

Other hazards may be present: positive protection for pedestrians must be identified in the Traffic Management Plan and be provided for each hazard.

### 3.7.1.2 Pedestrian Travel Path

In comparison to other travel modes walking requires considerable effort so pedestrian travel paths through work zones should minimize detours and eliminate backtracking. Pedestrians may otherwise be tempted to take dangerous ‘shortcuts’ across or along traffic and through an active work zone. In order of preference:

- Keep sidewalks open while providing protection from the work zone.
- If a sidewalk must be closed, provide a parallel diversion route (which may require temporary parking removal, ramps or paths).
- If a parallel diversion route is not feasible, provide a detour route which minimizes additional time and distance. As shown in [TS-23](#), [TI-17](#), [US-30](#), [UI-29](#), [DS-22](#), and [DI-29](#), place TC-40 and other sidewalk signs at upstream intersections where an alternate route is available, rather than mid-block.

#### NOTE

Provide pedestrian travel paths which replicate original conditions as closely as possible.

Guidance to pedestrians should be positive and clear.

- Install **barricades (such as TC-53) or channelization** which are continuous longitudinally. The top of a pedestrian barricade shall be located at a minimum of 1.0 metre above the surface on which it is installed.
- Install **directional and informational signage** specifically for pedestrians. Signage should be repeated in advance, transition and work areas.
- Provide **sufficient illumination levels**, from permanent and/or temporary lighting, to allow pedestrians to be safely guided through the temporary path.

#### NOTE

Pedestrians must be provided with a safe, convenient, and clearly delineated travel path.

Pedestrian paths through work areas must comply with AODA requirements and should be designed considering local usage.

- **Minimum sidewalk or path widths** for pedestrians should be 1.2 metres. Minimum widths should be increased (1.8 m) in areas with vulnerable pedestrians (seniors, disabled, families with strollers and small children) or large numbers of pedestrians (e.g. commercial or school areas). Multi-Use Paths accommodating both pedestrians and cyclists should be at least 3.0 m wide.
- Barricades or channelization should have **continuous detectable edging** at bottom and top to be detectable by cane.

- All **AODA path geometry requirements** (ramps, slope, etc.) must be met on temporary paths. Accessible ramps must be provided between a closed sidewalk and a diversion route on the roadway.
- **Temporary path material** must not cause a hazard to pedestrians using mobility aids or having vision loss.
- **Other temporary conditions** or situations, such as modified rail grade crossings, should be appropriately demarcated.

Pedestrian traffic control devices must be routinely inspected and are not to be used for the control or channelization of moving vehicular traffic.

### 3.7.1.3 Temporary Pedestrian Crossings

Pedestrian crossing facilities may be affected by temporary conditions.

- All **temporary traffic signals** shall include pedestrian signal heads if present in the permanent installation. The same AODA requirements (detectable, audible, location relative to sidewalk, etc.) shall be maintained where they are present in the permanent installation.
- **Sightlines to and from all pedestrian crossings** (permanent or temporary) must be maintained through all stages of construction. Motorists must be able to see pedestrians at the curb waiting to cross, particularly at Pedestrian Crossovers and school crossings. Pedestrians must be able to see traffic from all directions, including turning vehicles.
- **Trail crossings** (controlled, uncontrolled, or grade-separated) should be accommodated through temporary crossings or detours. Advance signage on trails should be provided.
- **Other temporary conditions** or situations, such as modified rail grade crossings, should be appropriately demarcated.

In some work zones it may be advisable to create a **temporary crossing facility** as an alternative to a closed crossing. OTM Book 15 (Pedestrian Crossing Facilities) should be consulted to determine appropriate type and design requirements.

### 3.7.1.4 Pedestrian Access Within Work Zones

Pedestrians require access to destinations within and adjacent to the work zone. Considerations may include:

- Transit stops and routes.
  - Provide safe access to and from existing transit stop locations whenever possible.
  - Coordinate the relocation or removal of transit stops.

- Maintain existing transit routes by providing sufficient lane widths and turning radii whenever possible.
- Coordinate with transit agencies to provide advance and ongoing notification of stop or route changes to users.
- Buildings/businesses
  - Maintain continuous pedestrian access to all buildings, especially businesses, if possible.
  - Stage work as required to allow access from at least one direction.
  - Provide informational signage indicating access routes and that businesses are open, as well as ingress/egress signage.
  - Place Traffic Control Persons to indicate when pedestrians can enter safely.

### 3.7.2 Cyclist Safety Considerations

---

Cyclist safety considerations must be explicitly considered in all work zones, except where bicycles are legally prohibited, as they have the same right to safe passage as motor vehicles under the HTA. These principles should be followed:

- Modify conditions on the roadways which create hazards specifically for cyclists.
- Provide traffic control and delineation considering cyclist requirements.
- Maintain the same type of cycling facility if possible. In some municipalities there are by-laws requiring that cyclists be accommodated.
- Provide advance notice in time and space of unexpected conditions, as delays and restrictions may be more problematic for cyclists than for motor vehicle users.

When assessing options for the treatment of the cyclists through a work zone, a practitioner should consider:

- The volume of cyclists using the route.
- Who is using the route, such as children going to school.
- The importance of the route in the cycling network/the availability of alternate routes.
- The operating speed and traffic volumes of the roadway.
- The length and timeframe of the closure or disruption, including the season.
- Whether there will be unavoidable disruptions to the grade or surface quality of the roadway as part of the work.
- Whether the route is signed and/or mapped as a designated cycling facility.

Designated cycling facilities are of the following types, from greatest to least level of separation:

- Off road trails.
- In-boulevard Multi-Use Paths (MUP).
- Physically separated cycling lanes.
- Cycle tracks.
- Bicycle lanes (buffered, conventional and advisory).
- Paved shoulders.
- Neighbourhood bikeways.
- Shared roadway (side by side, or single file).

Complete description of bicycle facilities and their selection is found in OTM Book 18 (Cycling Facilities), for non-provincial highways and the MTO Bikeways Design Manual for provincial highways.

### 3.7.2.1 Cyclist Protection in the Work Zone

Some conditions may pose hazards to cyclists but not to motorists. These hazards and potential mitigations include:

#### **Excavations and moving equipment**

- Conditions in the boulevard or adjacent to a paved shoulder may pose a greater risk to cyclists.
- A temporary construction barrier shall be considered when there is a drop-off, trench, or moving equipment within 1.0 m of the edge of the pavement or the active transportation facility. Do not use mesh fencing, caution tape, cones, or other materials which do not provide positive cyclist protection.
- Barriers or sturdy fencing used for the protection of cyclists should be at least 1.8 m high so that cyclists or other members of public do not fall over them.
- Traffic Control Persons allowing construction vehicle or equipment movement should explicitly control cyclists if a designated facility or significant cyclist volumes are present.

#### **Surface conditions**

Safe cycling requires a higher standard of travel surface than motor vehicle operation. When a cyclist is directed through the work zone, the following considerations must be given to surface conditions.

- Providing a smooth, hard travel surface.

- Asphalt is ideal, but a compacted granular surface is acceptable for temporary use if well-maintained.
  - Avoid loose gravel, compacted aggregate, sand, mud, and standing water.
  - Sweep surfaces regularly, especially the outer 2.0 metres of the curb lane.
- NOTE**

Safe cycling requires a higher standard of travel surface than for a motor vehicle.
- Ensure that temporary surfaces (e.g., steel plates, timber decking) are skid-resistant with smooth joints at right angles to the travel path.
  - Minimize vertical discontinuities. Where cycling volumes are high and discontinuities are unavoidable (e.g., at road cuts, raised ironworks, steel plates that are not recessed into the pavement), consider mitigating them with asphalt ramps. Use reflective paint and place devices (such as barriers, barrels, or cones) to direct cyclists away from un-ramped grade changes.
  - Cyclists may need additional lateral clearance when the cycling surface is rough. If so, consider providing a separate bike lane rather than a shared lane through the work zone.
  - Use signs to notify cyclists of any variance from a smooth asphalt condition, where appropriate.

### Obstructions

- Provide an obstruction-free path wherever possible.
- Ensure that signs do not intrude into the travel path of cyclists; if intrusion is unavoidable, maximize sign visibility.

### Alternating one-way traffic flow

Consideration should be given to the lower speed of cyclists to enable them to safely clear the work zone when a single lane bi-directional temporary condition is controlled by Traffic Control Persons (TCP) or temporary signals.

- TCP should communicate to each other about the presence of cyclists in the work zone.
- The timing of temporary signals should consider the time required for cyclists to travel through the work zone. Cyclist operating speed used to calculate clearance time should consider:
  - Surface treatment.
  - Available lines of sight.
  - Existence of potential areas of refuge for cyclists in the work zone.

### 3.7.2.2 Modified/Temporary Cycling Facility

If a work zone in or adjacent to a cycling facility is required, every effort should be made to minimize disruption to the facility. Generally, the level of separation provided during temporary conditions should be consistent with the original infrastructure. If the cycling facility is a physically separated bikeway, it is recommended that physical separation from traffic be maintained through the temporary facility.

#### Separate cycling facilities

Types of separate cycling facilities are off road trails, in-boulevard Multi-Use Paths (MUP), physically separated cycling lanes, cycle tracks, bicycle lanes (buffered or conventional) and designated paved shoulders for cycling.

- In constrained conditions, the cycling facility may be narrowed to create a minimum operating space of 1.5 m between physical barriers, or 1.2 m between painted lines.
- The alignment of MUP, cycle tracks, bicycle lanes or paved shoulders may be diverted within the right of way, if required (Example layouts are shown in [TS-24](#), [TS-25](#), [US-31](#), [US-32](#), [DS-23](#), [DS-24](#)).
- If a lateral realignment is required, a 6:1 taper of the cycling facility is recommended to avoid abrupt changes in direction for cyclists.
- Where a cycling lane must taper towards motor vehicle lanes, practitioners should assess the risk of vehicles infringing on the cycle lane and consider the use of physical protection such as barrels (TC-54), flexible bollards (TC-52) or TCBS.
- Any barriers separating cycling facilities and motor vehicle lanes should not be higher than 0.6 m high, so cyclists remain visible to drivers.
- Ensure that alignment changes through intersections do not compromise required sightlines to/from motorists and cyclists.

#### NOTE

Narrowing of motor vehicle lanes where feasible should be prioritized over narrowing of the cycling lane.

#### Mixed traffic operation

Mixed traffic operation includes designated Shared Roads (side by side, or single file), neighbourhood bikeways and advisory bicycle lanes.

- Preserve an acceptable shared lane width through the work zone:
  - Side by side shared lanes should be at least 4.3 m wide to accommodate HTA requirements for drivers to maintain at least 1.0 m separation from cyclists.
  - Single file lanes should be wide enough to accommodate the expected vehicular traffic.



- A two-way centre travel lane width between 4.0 and 5.0 m with advisory bicycle lanes is not recommended.
- Notify cyclists of any reduction in shared lane width in the work zone and reaffirm the shared lane condition by posting temporary condition Share the Road signs.
- Consider removing on-street parking, or providing a cyclist detour, if reduced shared lane width requires cyclists to travel within 0.6 m of parked cars (1.0 m is preferred).

### 3.7.2.3 Change in Cyclist Facility Type

If cyclist traffic through the work zone cannot be accommodated using appropriate modifications to the original facilities, the type of cyclist facility provided can be changed. Only facilities appropriate for the posted speed, average daily traffic and context should be used. OTM Book 18 and MTO Bikeways Design Manual provides nomographs for urban/suburban and rural contexts which show desirable cycling facilities.

#### NOTE

Temporary cyclist facility type should be selected using OTM Book 18 and MTO Bikeways Design Manual nomographs.

#### Conversion to shared roadway

Separate cycling facilities can be temporarily converted to shared roadway in some circumstances and with appropriate signage.

- A temporary shared roadway may be used if the posted speed is no greater than 40 km/h in urban/suburban context or if the average daily traffic volume is no greater than 1000 vehicles (at 60 km/h) in a rural context, as per facility selection from OTM Book 18 and MTO Bikeways Design Manual.
- Use Bicycle Lane Ends sign (TC-43) and temporary condition Share the Road or Single File signs (Example layouts are shown in [TS-27](#), [US-34](#), [DS-26](#)). Apply distance tabs in advance of cycling facility closure, where appropriate.
- If a Single File shared lane is the only traveled lane in that direction consider prohibiting motor vehicles from passing cyclists.



#### Diversion to adjacent sidewalk or pathway

In certain work zone conditions, it is appropriate to divert cyclists onto an adjacent sidewalk or pathway.

- A temporary Multi-Use Path (MUP) can be created if the pedestrian facility is wide enough (3.0 m or greater) to accommodate both cyclist and pedestrian volumes (Example layouts are shown in [TS-26](#), [US-33](#), [DS-25](#)).

- Appropriate signage for both cyclists and pedestrians, tapers and temporary ramps from the roadway to temporary MUP must be provided. Sidewalk railings adjacent to hazards (e.g., on bridges) may require modification to achieve a minimum height of 1.5 m.
- For closures over very short distances, it may be acceptable to instruct cyclists to dismount and walk on the pedestrian facility. In some instances, this may be more beneficial to the cyclist than providing a detour. (Example layouts are shown in [TI-19](#), [UI-31](#), [DI-31](#)).

**NOTE**

Closing a cycling facility and requiring cyclists to dismount should be avoided wherever possible.

### 3.7.2.4 Cyclist Detours

Detours and alternative routes should be provided when on-route accommodations are not possible. Detours do not require special signage for cyclists unless it is a bicycle-specific detour.

- All roadways on the detour route should already be designated cycling facilities or appropriate for the cycling facilities to be provided, as per OTM Book 18 (Cycling Facilities) and MTO Bikeways Design Manual.
- Provide early notice of projects that could cause significant inconvenience to cyclists (e.g., long detours), making use of cyclist organizations or user groups where available.
- Cyclist detour signage provides both advance notice of the detour and guidance along the detour route. (Example layouts are shown in [TI-18](#), [UI-30](#), [DI-30](#)).

## 3.8 Visibility Considerations

A well-planned and executed traffic control set up effectively communicates information to drivers passing through the work area. Communication is achieved through the placement of signs and devices appropriate for the desired action the driver must take to safely move around the work area. Visibility of signs and devices in the work area is, therefore, a critical factor to be considered when planning and installing effective traffic control measures.

### 3.8.1 Night-time Provisions

For planned night-time work operations, the following provisions must be considered for maximum visibility through the work zone:

1. For night-time work of any duration, traffic high visibility garments that meet the *Occupational Health and Safety Act (OHSA)* requirements for night-time work must be used.

**NOTE**

Care must be taken to ensure that lighting used to illuminate the work site is not aimed at drivers.

2. All work vehicles present, must have four-way flashers and an amber 360-degree beacon (4WF/360°).
3. Where cones are used, they must be 700 mm with one standard white retroreflective (minimum Type III, high intensity) 100 to 150 mm wide cone collar mounted onto the upper one-third of the cone taper, 100 mm below the top of the cone.
4. Reflectorized barrels, TC-54, should be considered as an alternative to cones on multi-lane non-freeways, where conditions permit, and must be used on freeways.
5. Where a lane is closed or occupied, or during shoulder work where no work vehicle is in place, trailer mounted TC-12 flashing arrow board(s) or TC-7 and flashing amber light must be placed at the end of the taper.
6. For intersection zone painting, 450 mm cones with a white retroreflective (minimum Type III, high intensity) cone collar may be used instead of 700 mm cones during the painting operation. After painting is completed, while the paint is drying, a TC-4 may be used as a replacement for the TC-12.
7. Planned SD night-time work should not be conducted in fog or when highways are slippery.
  - a) If wet or slippery roads or poor visibility are present when emergency work must be performed, an advance trailer-mounted TC-12 must be used and positioned as soon as possible.
  - b) LD taper lengths (Table B) rather than SD taper lengths (Table A) should be considered.
8. Pedestrian barricades should be used where necessary to provide adequate protection and guidance to pedestrians in work zones.

## 3.8.2 Work Zone Lighting

---

### 3.8.2.1 Lighting of Work Area

Construction, maintenance, and other activities often create conditions that are particularly hazardous at night when the ability of drivers to see clearly is reduced. The need for illumination by floodlight or steady burning lamps must be thoroughly investigated, and the following must be considered:

1. The OHSA requires adequate lighting for its intended use.
2. Care must be taken to ensure that lighting used to illuminate the work site is not aimed at drivers, making it more difficult for them to see their intended path.
3. Lighting systems used for night-time work must be mounted at least 5.0 metres above the highway, except for dome or balloon style lights with soft wide light that does not produce glare.

4. Lighting should be set up so that it is aimed in an arc from 90 degrees to the traffic flow, up to 45 degrees away from the traffic, but under no circumstances should lights be aimed at, or spill over onto, oncoming traffic.
5. Any additional lighting mounted on construction or maintenance equipment should be directed and focused on the immediate work area and should not be used as general floodlights to illuminate a construction site.
6. Lighting should not interfere with the ability of motorists to navigate their way through the work zone.

**NOTE**

Lighting should not interfere with the ability of motorists to navigate through the work zone.

### 3.8.2.2 Highway Lighting through a Work Zone

Illumination of the driver's path through a construction work zone may:

- Assist the driver in making timely decisions.
- Partially compensate for an undesirable alignment.
- Lessen the visual impact of an illuminated work zone on the driver.

Night-time construction often requires that lighting of working areas be brighter than the adjacent highway. Although construction illumination is directed away from the driver's path, some illumination typically spills onto the pavement surface and is reflected into the driver's field of vision.

Illumination of the highway through a work zone can therefore reduce the impact of construction lighting on the driver.

### 3.8.2.3 Anti-glare Screening

Anti-glare screening on freeway construction work zones should be considered to reduce the impact of headlights on the driver where:

1. A crossover is built on a freeway.
2. The median width is reduced to 4.0 metres or less.
3. A curved highway alignment directs headlights into the path of opposing drivers.
4. Night-time truck volume is greater than 10%.
5. Night-time traffic volume is Level of Service (LOS) D, or greater.

Anti-glare screening should not be used in winter because of the impact on snow drifting.

## 4

**Temporary Traffic Control Devices**

Traffic control devices are an important part of a work zone. Section 4 provides general descriptions, applications, specifications, and quality replacement guidelines for typical traffic control devices in temporary work zones, as required for work on highways in Ontario. General guidance is also provided for the application of new technologies.

**Descriptions of Traffic Control Devices:**

- Will assist all users in understanding available and appropriate devices.
- Will be of interest to users required to either modify an existing typical layout or develop a new typical layout for a unique situation, which may require additional or alternate devices.

**Application of Traffic Control Devices**

- Traffic Control Devices are used as required for work on public highways and will be of interest to:
  - Designers, contractors, and road authorities in preparing or ordering a schedule of devices,
  - Any person who is deploying the devices in reference to typical layouts, and
  - Supervisors or enforcement officers in evaluating the compliance of devices on site.

**Specifications of Traffic Control Devices**

Specifications are to be used once devices have been identified based on the fundamental and guiding principles described in Sections 1 through 3, and/or through a layout.

Specifications for traffic control devices, covered in this section, include:

- Devices for channelization guidance and information.
- Devices to regulate and control the flow of traffic.
- Devices to provide advanced notification, warning, and alternate route.
- Positive protection devices.

Device specification is particularly relevant to designers, contractors, and road authorities in preparing or ordering a schedule of devices, any person who is deploying the devices in reference to layouts, and supervisors or enforcement officers in evaluating the compliance of devices on-site.

## Quality Replacement of Traffic Control Devices

Traffic control devices in work zones are often subjected to wear and damage, which may result in loss of effectiveness due to soiling, deformation, gashes, breakage, and loss of/damage to reflective sheeting, text, or symbols.

- Quality of traffic control devices in work zones depends on good visibility and legibility of the traffic control devices being used.
- Once a construction site has been correctly equipped with all necessary signs, markings, and other devices, they must be maintained in optimum operational condition.

### NOTE

Devices must be maintained in optimum operational condition.

## 4.1 General Quality Guidelines for Traffic Control Devices

All traffic control devices used in work zones must conform to the requirements of OTM Book 7 and contract documents with regard to size, shape, colour, placement, and legend message. Compliance to these documents must be maintained for the duration of the project. Section 25 (1)(b) of the OHSA places responsibility on employers to ensure that equipment, materials, and protective devices are maintained in good condition.

Device quality should be evaluated at various stages including:

- While in storage.
- While in preparation for drop off at a work zone.
- During installation.
- Regularly during the course of the work.

Good quality control throughout various stages of the work will reduce costs and minimize the need for replacement on-site.

Traffic control devices should be routinely inspected. Signs should be as near vertical as possible.

Any situation where there are more than two adjacent channelizing devices missing or substantially out of alignment will cause an unacceptable situation and should be corrected immediately. Traffic control devices should routinely be inspected at night to ensure that the level of retro reflectivity is adequate, and the devices are clearly visible, legible, and placed appropriately.

### NOTE

Traffic control devices should routinely be inspected at night.

For the purpose of Book 7, the quality of work zone devices has been divided into three categories, further defined in the [Table 4.1](#) below:

- Acceptable devices.
- Marginally acceptable devices.
- Unacceptable devices.

**Table 4.1 Quality of Acceptable Work Zone Devices**

Acceptable Devices	Marginally Acceptable Devices	Unacceptable Devices
<ul style="list-style-type: none"> <li>• Meet quality, design, size, and colour requirements.</li> <li>• May be used on highway construction, maintenance, utility, and other projects.</li> <li>• Percentage of acceptable devices shall be at least 50% at any time, or as contained in the contract specifications, or road authority requirements.</li> <li>• The 50% acceptability criterion applies to each traffic control device type taken by itself. (e.g., 50% of barrels, 50% of TC series signs, 50% of delineators etc.)</li> </ul>	<ul style="list-style-type: none"> <li>• At or near the lower end of acceptability for quality, design, size, and colour requirements.</li> <li>• May be used until they become unacceptable.</li> <li>• Percentage of marginally acceptable devices should not exceed 50% at any time and, if used, shall be interspersed with acceptable devices so that a sizeable length of a work zone does not have all marginally acceptable devices.</li> </ul>	<ul style="list-style-type: none"> <li>• Should not be delivered to the work zone or used on a work project.</li> <li>• Shall be replaced or repaired within 12 hours of notification, or as contained in the contract specifications or road authority requirements.</li> <li>• Where 10% or more of the surface of a traffic control device, or 20% of the retro-reflective material on a traffic control device is damaged or missing, the device is considered unacceptable and shall be removed from service.</li> <li>• For key communication items in a work zone, if the message or symbol on a traffic control device becomes unclear, the device is unacceptable.</li> </ul>

**NOTE**

The 50% acceptability criterion applies to each traffic control device type taken by itself. (e.g., 50% of barrels, 50% of TC series signs, 50% of delineators etc.)

Since it is not practical to require new devices at all times, some degradation of devices can be accommodated without significant loss of effectiveness; however, a standard of quality must be maintained.

### 4.1.1 Evaluation Guide for Traffic Control Devices

The selected traffic control devices illustrated in Figures 4.1 to 4.3, together with the accompanying descriptions, should be used as a guide to determine whether a device is acceptable, marginally acceptable, or unacceptable.

Such assessments are somewhat subjective, and devices can be worn or damaged in a wide variety of ways. All worn or damaged states cannot be practically depicted.

**Figure 4.1 Cones Quality Illustration**





Acceptable	Marginally Acceptable	Unacceptable
<ul style="list-style-type: none"> <li>Clearly identifiable conical shape, free-standing in its original position.</li> <li>Surface free of punctures, abrasions, splatter residue, and is washable.</li> <li>Reflective bands have little or no loss of reflectivity, with only minor tears and scratches.</li> </ul> 	<ul style="list-style-type: none"> <li>Some splatter residue, difficult to clean, minor discolouration.</li> <li>Reflective bands have tears and scratches but free of large areas of residue or missing material.</li> </ul> 	<ul style="list-style-type: none"> <li>Punctures, large areas of splatter residue, large areas of missing or stained reflective material.</li> </ul> 



Figure 4.2 Flexible Drums (TC-54 Barrels) Quality Illustration

Acceptable	Marginally Acceptable	Unacceptable
<ul style="list-style-type: none"> <li>• Minor tears and scratches on sheeting.</li> <li>• Any dents do not seriously reduce reflectivity.</li> <li>• Intended original shape is maintained.</li> </ul>	<ul style="list-style-type: none"> <li>• Numerous tears and scratches, but free of large areas of residue or missing or damaged reflective material.</li> <li>• Intended original shape and strength are maintained.</li> </ul>	<ul style="list-style-type: none"> <li>• Large areas of missing or damaged reflective material, or significant splatter residue.</li> <li>• If 20% of the retro-reflective material is damaged or missing, the device is unacceptable and shall be removed from service.</li> <li>• Substantial deformation, i.e., dented severely enough to affect overall dimensions or contain fractures that affect stability or ability to retain reflective sheeting, render a drum unacceptable.</li> </ul>
		

**NOTE**

If 20% of the retro-reflective material is damaged or missing, the device is unacceptable and shall be removed from service.

**Evaluation Guide for Pavement Tape and Paint**

Acceptable	Marginally Acceptable	Unacceptable
<ul style="list-style-type: none"> <li>All pavement marking tape or paint required (solid lines and skip lines) is in place and meets all material specifications.</li> </ul>	<ul style="list-style-type: none"> <li>No more than 10% of all tape, paint, message, or symbol, or no more than two consecutive skip lines, or no more than 15 continuous metres of solid line are missing.</li> </ul>	<ul style="list-style-type: none"> <li>More than 10% of all tape, paint, message, or symbol, more than two consecutive skip lines, or more than 15 continuous metres of solid line are missing.</li> </ul>

**Evaluation Guide for Temporary Raised Pavement Markers (TRPM)**

Acceptable	Marginally Acceptable	Unacceptable
<ul style="list-style-type: none"> <li>All TRPM required are in place and meet all material specifications.</li> </ul>	<ul style="list-style-type: none"> <li>No more than 10% of the total TRPM or no more than three consecutive TRPM are missing.</li> </ul>	<ul style="list-style-type: none"> <li>More than 10% of the total TRPM or more than three consecutive TRPM are missing.</li> </ul>



**Evaluation Guide for Flashing Arrow Board (TC-12)**

Acceptable	Marginally Acceptable	Unacceptable
<ul style="list-style-type: none"> <li>No more than one lamp in stem not functioning and all functioning in arrowhead.</li> <li>Properly dimming.</li> </ul>	<ul style="list-style-type: none"> <li>Two or fewer lamps in stem not functioning, all functioning in arrowhead.</li> <li>Properly dimming.</li> </ul>	<ul style="list-style-type: none"> <li>Three or more lamps in the stem not functioning, or any lamp not functioning in the arrowhead.</li> <li>Not properly dimming.</li> </ul>

**NOTE**

Any operating lamp which is out of alignment will be considered "not functioning".

Figure 4.3 Work Zone Signs Quality Illustration

Acceptable	Marginally Acceptable	Unacceptable
<ul style="list-style-type: none"> <li>• Minor abrasions, no loss of lettering. The message is legible.</li> <li>• All TC-21 TRAFFIC CONTROL PERSON AHEAD and TC-22 TRAFFIC CONTROL signs (STOP/SLOW paddles) in use must meet the “Acceptable” criteria.</li> </ul>	<ul style="list-style-type: none"> <li>• Many surface abrasions, including individual letters of message.</li> <li>• Sign surface is free of residue.</li> <li>• Background colour and reflectivity are still apparent at night.</li> <li>• The message is legible.</li> </ul>	<ul style="list-style-type: none"> <li>• Many abrasions and/or splatters.</li> <li>• Significant loss of letters or colour fading.</li> <li>• The message is partly missing or illegible.</li> </ul>
		

**NOTE**

All TC-21 TRAFFIC CONTROL PERSON AHEAD and TC-22 TRAFFIC CONTROL signs (STOP/SLOW paddles) in use must meet the “Acceptable” criteria.

## 4.2 Devices for Channelization, Guidance, and Information

The purpose of using traffic control devices for channelization, guidance, and information in temporary work zones is to:

- Alert highway users to hazards created by construction, maintenance, or other activities in or near the travelled way.
- Separate traffic from work areas, pavement drop-offs, or storage areas, and to direct highway users safely past hazards.
- Channelize highway users from one lane to another, into a detour, diversion, or to a reduced lane width.
- Delineate the highway alignment.
- Produce the desired behaviour in highway users.

Depending on the highway environment, traffic cones, construction markers, or flexible drums are used to channelize highway users and delineate its alignment. Typical devices used for channelization, guidance, and information include:

1. Traffic Cones.
2. Construction Markers.
3. Flexible Drums (Barrels).
4. Barricades.
5. Barriers.
6. Temporary Pavement Markings and Highway Delineation.
7. Signs.

Diagrams of these devices are shown in the following sections and include details regarding:

- General **purpose** and typical applications for each device.
- **Specifications** as required for work on public highways.
- **Evaluation** guide for a selection of traffic control devices to determine whether they are: acceptable, marginally acceptable, or unacceptable devices (See [Section 4](#)).

## 4.2.1 Traffic Cones

### Specifications

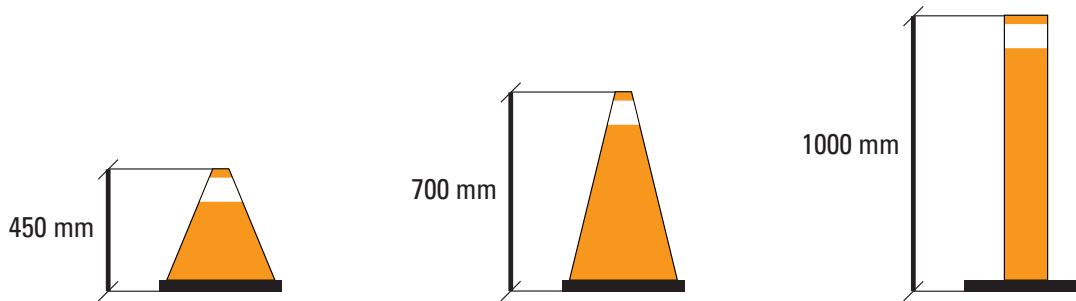

### Purpose

Traffic Cones (TC-51) are used to:

- Delineate diversions and closed lanes.
- Mark channelizing tapers in advance of closed or narrowed lanes.
- Delineate highway alignment, and guide traffic through the work area.
- Alert highway users to hazards or separate traffic from the work area.

Traffic cones are primarily used for Very short or Short Duration (SD) operations on non-freeways.

### Conditions

- The required spacing of traffic cones is provided in the appropriate table ([Table A](#), [Table B](#), and [Table C: 'D'](#)).
- All traffic cones must have a reflective white collar, 100 mm to 150 mm wide, mounted on the upper one-third of the cone taper, 100 mm below the top of the cone or marker (Type III or IV, high intensity reflective sheeting).
- Consideration should be given to other channelizing devices for high speed, high volume areas. Reflectorized TC-52 or TC-54 may be used, and in some cases, must be used as alternatives to cones.
- Cones affected by high winds should be used with ballast. The ballast must not present a hazard if the cone is struck. Suggested means of ballasting include:
  - Doubling the cones, or the use of heavier weighted cones.
  - Special weighted bases, or masses such as sandbag rings or ballast rings made of recycled tires.

#### NOTE

All traffic cones must have a reflective white collar.

**Size**

- **TC-51A: (450 mm) may be used for zone painting only.**
- **TC-51B: (700 mm) standard**
- **TC-51C: (1000 mm) standard**

## 4.2.2 Construction Marker

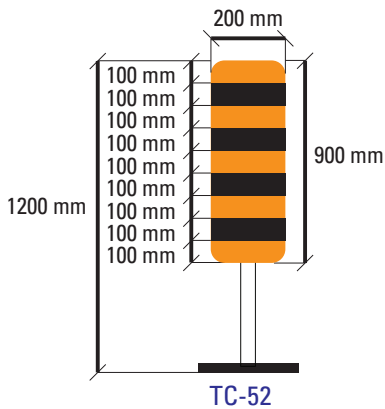
**Specifications****Purpose**

Construction Markers (TC-52) are used to:

- Delineate diversions and closed lanes.
- Mark channelizing tapers in advance of closed lanes.
- Delineate highway alignment and guide traffic through the work area.
- Alert highway users to hazards or separate traffic from the work area.

**Conditions**

- Required spacing of construction markers is provided in the appropriate table ([Table A](#), [Table B](#), and [Table C](#): 'D').
- Minimum sheeting of reflective horizontal bands is Type III, High Intensity.
- For high speed, high volume areas, consideration should be given to other channelizing devices (e.g., Flexible Drums (TC-54)).
- Appropriate bases and uprights (as approved by the highway authority) are necessary to ensure the stability of the marker and driver safety in both rural and urban areas.
- TC-52 must be used with ballast such as sandbags

**Size**

- **200 mm x 900 mm (sign size).**
- **Sign mounted, from bottom of sign, 300 mm above ground level.**

## 4.2.3 Flexible Drums (Barrel)

### Specifications

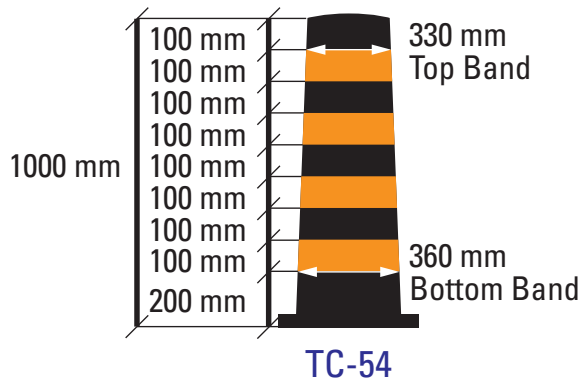

### Purpose

Flexible Drums (Barrels) (TC-54) are used to:

- Delineate diversions and closed lanes.
- Mark channelizing tapers in advance of closed lanes.
- Delineate highway alignment and guide traffic through the work area.
- Alert highway users to hazards.
- Separate live traffic lanes from work areas.

### Conditions

- When located near/on lane markings, drums may reduce adjacent lane capacity.
- Should be placed with care to reduce the likelihood of impact.
- An offset of 0.3 m to 0.6 m between flexible drums (barrels) and the edge of the travelled lane should be maintained.
- TC-54 must be used on freeways.
- Must be manufactured to include an anti-roll device in case of impact and shall not be constructed in a way that creates a hazard to vehicles.
- Must be ballasted in a manner that does not constitute a hazard to motorists or workers. Suggested means of ballasting include:
  - Ballast rings.
  - Sand bags (not more than 25 kg, not recommended for winter use).
- Must not be ballasted with rocks, chunks of concrete, or similar objects.
- Ballast shall not be placed on the top of the drums.

#### NOTE

The drum must be manufactured to include an anti-roll device in case of impact and shall not be constructed in a way that creates a hazard to vehicles.

### Size

- **1000 mm height.**
- **Top Reflective Band diameter 330 mm minimum.**
- **Bottom Reflective Band diameter 360 mm minimum.**

Markings of the flexible drums must be horizontal and circumferential, with alternating black and reflectorized orange stripes (four orange bands of High Intensity Type III or higher reflectivity that are approximately 100 mm each).

## 4.2.4 Barricades

### Purpose

Traffic Barricades (TC-53) are devices, typically with one or two rails, which provide a visual indicator of a hazardous location, or the desired path that a highway user should take but are not intended to contain or redirect a vehicle.

The primary function of a traffic barricade is to:

- Block off a portion, or all of a highway to discourage vehicular traffic from penetrating into work area.
- Delineate highway excavation sites or other work site hazards.

Barricades may be used for SD highway closures.

Barricades are only supplemental to other delineation devices and are not to be used as the primary delineation around an excavation or obstacle. Approaches to barricades should be adequately marked.

A general description of barricades for pedestrian safety is provided in [Section 3.7](#).

### Specifications

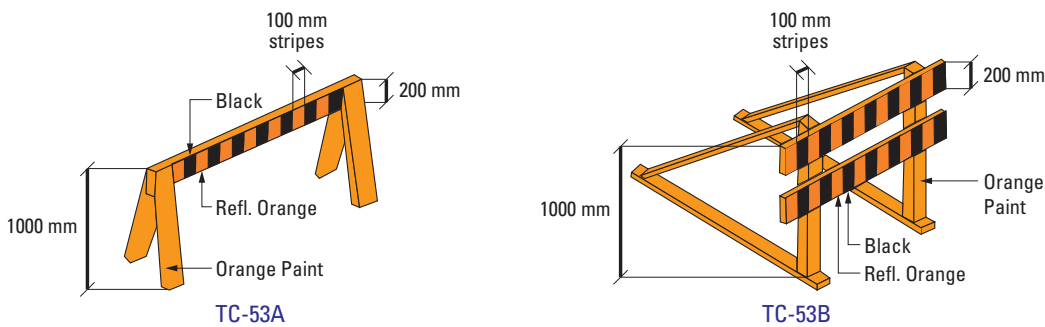

### Conditions

- The use of TC-53A or TC-53B depends on the approach speed of traffic and the nature and severity of hazards for which these devices provide awareness.
- The TC-53A or TC-53B must not be used as a channelizing device.

#### NOTE

The TC-53A or TC-53B must not be used as a channelizing device.



**Size**

- **One or two horizontal cross bars 200 mm x variable length, top edge mounted 1000 mm above ground level.**

## 4.2.5 Temporary Construction Barrier System (TCBS)

---

**Purpose**

A temporary construction barrier system, such as a Temporary Concrete Barrier, is a device which provides a physical limitation through which a vehicle would not normally pass and is intended to contain or redirect an errant vehicle of a particular size range at a given speed and angle of impact.

Barriers are primarily used as positive protection devices. Their use should be determined by the protection requirements of the location and should not be considered channelizing devices.

For general guidelines on the application of barriers as positive protection devices and when they are required, see [Section 4.5.3](#).

Barriers for worker and person safety, in and around the work site, including excavations where worker or person exposed to fall of 2.4 m are covered by O.Reg. 213/91, Sections 26.3 and 233(4) under the OSHA.

Temporary barriers used in Ontario must, at minimum, meet the requirements of MASH TL-3, Ontario Provincial Standard Specifications (OPSS), and be placed in accordance with the Ontario Roadside Design Manual.

[Table E Usage of Channelizing Devices, Barricades, and Barriers](#) in [Section 6](#) provides general guidelines for the use of cones, markers, barricades, and barriers.

**NOTE**

The use of barriers should be determined by the protection requirements of the location and should not be considered channelizing devices.

## 4.2.6 Temporary Pavement Markings, and Highway Delineation

---

### 4.2.6.1 Temporary Pavement Markings

**Purpose**

Temporary pavement markings are used to mark the intended vehicle path that traffic is to follow, normally in combination with:

- Appropriate signs.
- Channelizing devices.
- Delineation.

Where possible, highway users within a work zone should be provided with pavement markings comparable to the markings normally maintained along adjacent highways.

Temporary pavement markings must be maintained:

- In Long Duration (LD) stationary work zones on non-freeways.
- In both LD and SD work zones on freeways where traffic is diverted from its normal path.
- Where guidance by appropriate signs, channelizing devices, or delineation does not clearly and adequately indicate the required vehicle path.

Temporary pavement markings should also be considered on projects with partial pavement removal (milling) and markings should, as closely as possible, reflect the pavement markings which have been removed.

Temporary No Passing zones should be marked within a construction zone, where lane changing is discouraged.

### General Specifications

General specifications for temporary pavement markings are detailed below:

- Details on colour, pattern, and retro-reflectivity of pavement markings are provided in OTM Book 11 (Pavement, Hazard and Delineation Markings).
- Temporary pavement markings must comply with the standards prescribed in OTM Books 7 and 11.
- Any deviations from the standard are subject to approval by the road authority.
- Temporary pavement markings must align with the existing markings at both ends of a work zone.
- Markings shall be placed on hard-surfaced detours or temporary alignments before they are opened to traffic.
- Directional dividing lines shall be placed, replaced, or delineated where appropriate before the highway is opened to traffic.

#### NOTE

Deviations from the standard for pavement markings in OTM Books 7 and 11 are subject to approval from the road authority.

### Colour

Pavement markings are generally white or yellow unless otherwise stated. Where there is little colour contrast between the pavement and the white pavement markings, the contrast may be improved by:

- Using black in the gaps of a broken pavement line.
- Using marking tape with white stripes bordered by black on both sides.
- Applying white paint over a double-application black painted line.
- Using orange temporary pavement markings. Orange pavement markings should only be used for temporary alignment changes on divided multi-lane highways and are described further in [Section 4.2.6.2](#).

**NOTE**

Orange pavement markings should only be used for temporary alignment changes on divided multi-lane highways.

### Temporary Raised Pavement Markers

Where temporary markings are placed in accordance with the principles of colour and pattern described in OTM Book 11, temporary raised pavement markers may be used as an enhancement. These markers provide:

- Enhanced retro-reflectivity at night.
- Enhanced delineation through alignment changes.
- Reinforced travel path through areas where there may be confusion resulting from removal of existing markings which can cause scarring and/or phantom marks under certain lighting conditions (e.g., low sun angle from sunrise or sunset)

### Removal of Existing Markings

Pavement markings that are no longer applicable or do not define the safe path of travel must be removed, as soon as practical, to prevent motorist confusion.

Markings are commonly removed by blasting (soda, water) or grinding.

Removal should minimize damage to the highway surface or texture. Thermoplastics and permanent tapes are generally more difficult than paints to remove effectively. Temporary tapes are fabricated to be easily removed by hand and are the preferred solution.

Although painting over invalid markings with black paint or bituminous solutions can be a satisfactory solution for the short-term, this method is not a preferred removal technique for the following reasons.

- The covering material wears, so that the invalid markings eventually reappear.
- Markings covered in this way remain visible under some low-light conditions.

### Short Term Pavement Markings

Short term pavement marking is required when a paved highway is to be opened to the general public prior to the application of permanent markings. Permanent pavement markings must be installed on freeways of six or more lanes before opening to traffic. On other highways, if permanent

pavement markings cannot be installed immediately, interim temporary pavement markings must be installed, followed by permanent markings within the time frames and for the highway types noted below:

- Four-lane freeways – within 15 working days.
- Multi-lane non-freeways – within 15 working days.
- Two-lane highways – within 20 working days.

In these situations, short term pavement markings should be 0.3 metre (length) markings with 15 metre gaps. If No Passing zones cannot be marked during the interim period, they must be established by using signs (Rb-31 DO NOT PASS and Rb-35 PASSING PERMITTED).

### 4.2.6.2 Orange Temporary Pavement Markings

#### Purpose

Orange temporary pavement markings should primarily be used on divided multi-lane highways with a normal posted speed of 90 km/h or higher, where there are changes in alignment to accommodate construction staging and there is the need to:

- Reduce driver confusion resulting from removal of existing markings on asphalt, which can cause scarring and/or phantom marks under certain lighting conditions (e.g., low sun angle from sunrise or sunset).
- Improve the contrast on concrete (i.e., the contrast between orange markings and light-coloured concrete is much better than that between white markings and concrete).
- Enhance daytime and night-time visibility.
- Provide an additional visual cue to indicate that the highway user is within a construction zone.

#### NOTE

On provincial highways, orange pavement markings are only to be used when recommended by Regional Traffic.

On provincial highways, orange pavement markings are only to be used when recommended by regional Traffic.

#### Specifications

When orange temporary pavement markings are used:

- The markings should be applied at the start of the transition, leading up to the new alignment, and continue through the entire length of the construction zone up to where traffic returns to the original alignment.

- All longitudinal lines within a construction zone, including left edge, skip, right edge, interchange, and High Occupancy Vehicle (HOV) lane markings, shall be orange in colour and markings shall be applied to highway surfaces and not over existing pavement markings.
- All existing pavement markings within a construction zone shall be removed according to road authority specifications.
- Fluorescent orange markings can also be used at the discretion of the road authority when there are operational concerns as a result of multiple sets of pavement markings. This may include areas where the speeds are less than 90 km/h or areas where operational problems may be confusing to the driver.
- They shall be applied in accordance with the manufacturer's recommendations and within the temperature limits recommended by the material manufacturer.

Other considerations for the use of orange temporary pavement markings include:

- Using during winter shut down operations if existing construction staging and temporary construction signing remain in effect over the winter months.
- The type of material being used as orange temporary pavement markings must consider:
  - Pavement surface.
  - Ambient temperature at the time of application.
  - Annual average daily traffic.
  - Expected service life duration.
- The length of the stage(s) and if orange temporary pavement markings are to be placed on asphalt that will not be resurfaced upon the completion of construction.
- The actual service life of any marking material will vary, depending on turning movements, traffic volume, and level/type of winter maintenance activities at the specific site.

#### NOTE

The type of material used as orange temporary pavement markings must consider the pavement surface, ambient temperature at the time of application, annual average daily traffic, and expected service life duration.

### 4.2.6.3 Highway Delineators

#### Purpose

Delineation of the highway during daytime can be effectively accomplished with pavement markings. However, night-time visibility often requires the use of delineators to provide long-range demarcation of the highway alignment. Furthermore, delineators remain visible under adverse weather conditions.

Delineators are small retro-reflective devices that:

- Are erected in series to guide drivers and are typically mounted on posts or barriers or in the highway.
- Define the horizontal alignment of the highway and help the driver to identify its limits.
- Are guidance devices and are generally not intended as warning devices.

**NOTE**

More than one type of device can be used to delineate the highway, but the application should be consistent throughout the work zone.

They are placed in or on the highway:

- Adjacent to the shoulder (in rural areas).
- On the edge of the travelled portion of the highway (in urban areas).
- On the top or side of the median or temporary barriers.

More than one type of device can be used to delineate the highway, but the application should be consistent throughout the work zone. Types of delineation include:

- Temporary raised pavement markers (TRPM).
- Painted curb markings (islands).
- Small reflective post-mounted delineators.
- Barrier-mounted delineators.
- TC-18 CHEVRON ALIGNMENT sign.

Delineation of the highway can also be provided with:

- Cones.
- Construction markers.
- Flexible barrels (drums).

Delineation is more fully addressed in OTM Book 11 (Pavement, Hazard and Delineation Markings).

### Specifications

The following specifications apply to delineators:

- All in-service delineators must, as a minimum, employ materials that conform to ASTM D4956-19a or its subsequent revisions for Type III (high intensity) and Type IV (prismatic) materials.

**NOTE**

Delineator conditions must be regularly inspected, and maintenance or replacement of damaged delineators should be implemented as soon as practical.

- Off-roadway delineators should be installed so they are within the driver's cone of vision and positioned:
  - 1.25 metres to 4.0 metres from the edge of the roadway.
  - 0.6 metres to 2.4 metres beyond the outside edge of a shoulder.
  - In line with a highway barrier that is 2.4 metres or less beyond the outer edge of a shoulder.
- Delineators should be placed at a constant distance from the edge of the roadway.
- Post-mounted delineators or barrier-mounted delineators should be placed on or as close as possible to a temporary barrier, at spacings from 20 metres to 40 metres.
- Delineator conditions must be regularly inspected. Maintenance or replacement of damaged delineators should be implemented as soon as practical.

## 4.2.7 Signs

There are three classifications of signs used in temporary conditions: regulatory, warning, and guide.

Warning and guide signs include both passive as well as dynamic signs that allow for illuminated and/or changeable messaging.

Signs are placed in positions where they will most effectively convey the message without restricting lateral clearance or sight distance, and at advance distances that will allow a sufficient response time.

### NOTE

There are three classifications of signs that are used in temporary conditions: regulatory, warning, and guide.

### 1. Regulatory Signs

Regulatory signs impose legal obligations and/or restrictions on all traffic.

While temporary traffic control is most commonly accomplished through warning signs, there are situations where the use of regulatory signs becomes necessary. These situations can include closures of highways, turn restrictions and enforcement of speed reductions.

Regulatory signs must conform to OTM Book 5 (Regulatory Signs).

### 2. Warning Signs

Warning signs for temporary conditions are the most important signs used to advise highway users of specific hazards that may be encountered.

Warning signs for construction and maintenance or other work within a highway are typically:

- Diamond-shaped with an orange reflectorized background and a black symbol and/or legend message and a black sign border.

- Standard black on yellow where warning signs refer to permanent conditions that exist before, during, and after construction (e.g., steep hill, merge).

### 3. Guide Signs

Guide signs are required to guide traffic around or through work areas or provide information to highway users related to detours, directions and types of construction.

Guide signs, with few exceptions, have a rectangular shape with the longer dimension being horizontal. However, in some locations, because of lateral space limitations, the longer dimension may be vertical.

Temporary conditions guide signs typically have either:

- A white reflectorized background with a black legend and a sign border. Part of the sign legend may be black on orange to tell the driver about the specific condition related to the work zone.
- An orange reflectorized background with a black legend and sign border.

Guide signs that indicate highway names and directions generally have a reflectorized green or blue background with a white legend and border, or a white background with a black legend.

To show changes due to construction black legends or symbols on an orange reflectorized background may be used as an overlay on existing directional guide signs.

Where conspicuity of the ground mounted guide signs compared to other temporary conditions (black/orange signs) is an issue, the road authority may require standard guide signs to be used.

#### Sign Designation for Temporary Conditions

Most of the signs in OTM Book 7 are designated by the letters “TC” followed by a number. The letters “TC” indicates the “Temporary Conditions” series of signs.

Regulatory signs used in temporary conditions have been given “Rb” numbers.

Sign pattern files are provided on the CD contained in OTM Book 2 (Sign Design, Fabrication & Patterns).

Roll-up signs may be used however, they are not recommended for use on freeways and they must conform to the sign specifications outlined in the OTM Book 7 and OTM Book 2. Roll-up signs must meet the ASTM Type VI specification and must conform to the retro-reflectivity level specified in [Table 4.3 Minimum Retro-Reflectivity Requirements](#).



## 4.2.8 Traffic Control Sign Specifications

This section provides detailed descriptions of the purpose and proper use of each sign typically used in temporary traffic control.

General guidelines for size, retro-reflectivity, material, and installation are provided below. Where specifications are prescribed in the descriptions for individual signs (in [Section 4.2.8.5](#) or Layouts), they must be used.

### NOTE

All French translations must be approved by the road authority.

Dimensions, including supports, positioning, and pertinent installation details for all signs, including all temporary condition signs are shown in OTM Book 1b (Sign Design Principles), OTM Book 2 (Sign Design, Fabrication & Patterns) and OTM Book 3 (Sign Support and Installation).

Full scale patterns for the signs indicated herein are available in the OTM Book 2 CD.

All French translations must be approved by the road authority.

### 4.2.8.1 Sign Size

**The Standard** sign sizes shown in OTM Book 7 are recommended for typical work zones in two-lane and multi-lane (up to 4 lanes) highways with Normal Posted Regulatory Speed (NPRS) of 80 km/h or lower.

**Oversized sign sizes** are preferred on multi-lane (more than 4 lanes) highways with a Normal Posted Regulatory Speed (NPRS) greater than 60 km/h but less than 90 km/h, and are required on highways with NPRS of 90 km/h or higher.

Where dimensions are not prescribed in the descriptions for individual signs (in [Section 4.2.8.5](#) or Layouts), [Table 4.2 Minimum Dimensions of Work Zone Warning Signs](#) provides a general guideline of sign sizes to be used for a range of work zone situations.

**Table 4.2 Minimum Dimensions of Work Zone Warning Signs**

Highway Type	Normal Posted Regulatory Speed (km/h)	Sign Size	
		Standard	Oversized
Two-lane and Multi-lane (up to 4 lanes)	80 or lower	X	
	90 or higher		X (preferred where space permits)*

Highway Type	Normal Posted Regulatory Speed (km/h)	Sign Size	
		Standard	Oversized
Multi-lane ** (more than 4 lanes)	60 or lower	X	
	70 to 80		X (preferred where space permits)*
	90 or higher		X
Freeways **	All		X

\* If space does not permit an oversized sign, signing is to be repeated on the right side.

\*\* On divided highways, signing is to be repeated on the left if there are more than two lanes in one direction. Supplementary signs may be located on the left side of the highway where the median is wide enough to safely accommodate the signs or repeated on the right side if the median is too narrow.

**NOTE**

Oversized signs are required on highways with a NPRS of 90 km/h or higher.

### 4.2.8.2 Sign Retro-Reflectivity Standards

Regulatory, warning, and guidance (directional) signs need to be legible and conspicuous at night as well as during the day. General standards include:

- The colour of the sign must appear to be the same at night as by day.
- The retro-reflectivity of a sign is important for maintaining a satisfactory level of sign legibility and conspicuity at night.
- Retro-reflectivity requirements stated in Book 7 are the minimums.
- Standard levels for reflectivity are identified as Type I through Type XI and are defined in detail in ASTM D4956-19, or its subsequent revisions, and in OTM Book 2.

Signs that are the most important to ensure highway user and worker safety must have the highest levels of reflectivity. Temporary Conditions signs are grouped into two levels of importance with a corresponding minimum background reflectivity:

- Lowest level signs must have a minimum background reflectivity of Type III (high-intensity).
- Highest level signs must have a minimum background reflectivity of Type VII (high reflectivity micro-prismatic fluorescent).

Except for TC-12, higher reflectivity may be used where the road authority considers it necessary;

however, the relative importance of the signs in the two-level hierarchy should not be lost in doing so.

As of January 1, 2022, newly installed temporary conditions signs must meet the minimum reflectivity levels stated in OTM Book 7. As of January 1, 2026 all temporary conditions signs must meet the minimum reflectivity levels stated in OTM Book 7. Please refer to OTM Book 5 (Regulatory Signs) and OTM Book 6 (Warning Signs) for minimum reflectivity requirements. The sheeting levels indicated above for fabricating OTM Book 7 signs must conform to the ASTM (American Society for Testing and Material) Standard Specification D4956-19 or its subsequent versions.

The minimum reflectivity requirements for various signs are shown below in [Table 4.3 Minimum Retro-Reflectivity Requirements](#).

**Table 4.3 Minimum Retro-Reflectivity Requirements**

Minimum Retro-Reflectivity	Signs/Devices	Importance Hierarchy
Type VII or greater (min. high reflectivity micro-prismatic fluorescent, Type VII)	TC-1, TC-1A, TC-1B, TC-2A, TC-2B, TC-3, TC-4, TC-9, TC-16, TC-18, TC-21, TC-22 ("STOP and SLOW" side) double-sided SLOW Paddle	Highest (highest reflectivity level)
Type III/IV (min. high intensity, Type III)	All other temporary condition signs	Lowest (Lowest reflectivity level)

### 4.2.8.3 Sign Material and Thickness

Typical materials and thicknesses for signs are:

- Aluminum with a thickness of 2.0 mm.
- Galvanized steel with a thickness of 1.6 mm.
- Plywood with thicknesses of:
  - 19 mm - standard for use on provincial highways.
  - 12.5 mm - may be used for sign sizes of 1200 mm x 1200 mm, or smaller.

Signs larger than 900 mm x 900 mm should be made of plywood rather than aluminum or steel. Plywood may also be used for smaller signs.

Other materials for signs are:

- Fibreglass.
- Reinforced plastic or other material.

#### NOTE

The use of plastic or other material as sign blank material is subject to approval by the road authority.

These materials may be substituted for some aluminum or galvanized steel sign blanks.

The use of plastic or other material as sign blank material is subject to approval by the road authority.

Roll up signs are often made of flexible material to allow ease of transportation while still meeting minimum reflectivity requirements in [Section 4.2.8.5](#).

[Table 4.4 Standard Sign Blank Descriptions \(MTO\)](#) lists the blank numbers as assigned by the MTO and the corresponding sign dimensions of more common signs.

**Table 4.4 Standard Sign Blank Descriptions (MTO)**

MTO Blank Number	Size (mm)	MTO Blank Number	Size (mm)
B-8	300 x 900	B-25b	300 x 600
B-9	200 x 900	B-27	900 x 900
B-10	450 x 450 trapezoidal	B-29	900 x 1200
B-11	450 x 450	B-30	1200 x 1200
B-12	450 x 750	B-38a	900 x 1800
B-13	450 x 900	B-43	1200 x 1800
B-15	450 x 600	B-44	1200 x 2100
B-17	610 x 610	B-45	1200 x 2400
B-18	600 x 600	B-52	600 x 750
B-20	600 x 900	B-54	900 x 2400
B-23a	750 x 750	B-55	1500 x 2400
B-25a	200 x 600		

#### 4.2.8.4 Positioning and Installation of Signs

Comprehensive coverage of sign installation is found in OTM Book 3 (Ground Mounted Sign Support and Installation).

Specifications for sign installation in work zones follows:

- Signs should be located where drivers expect to see them, typically on the right side of the highway and must be in a position where they can be readily seen by highway users at all times.

- Supplementary (i.e., repeated signs) should also be used on freeways or on multi-lane highways where experience has shown that drivers fail to see the primary signs. See [Table 4.2 Minimum Dimensions of Work Zone Warning Signs](#).
- Supplementary signs may be located on the left side of the highway where the median is wide enough to safely accommodate the signs or repeated on the right side if the median is too narrow.
- Signs must be placed in positions where they will most effectively convey the required message without restricting lateral clearance or sight distance, and at advance distances that allow sufficient response time.

Typical sign placement is shown below in [Figure 4.4 Typical Sign Placement](#).

**Figure 4.4 Typical Sign Placement**

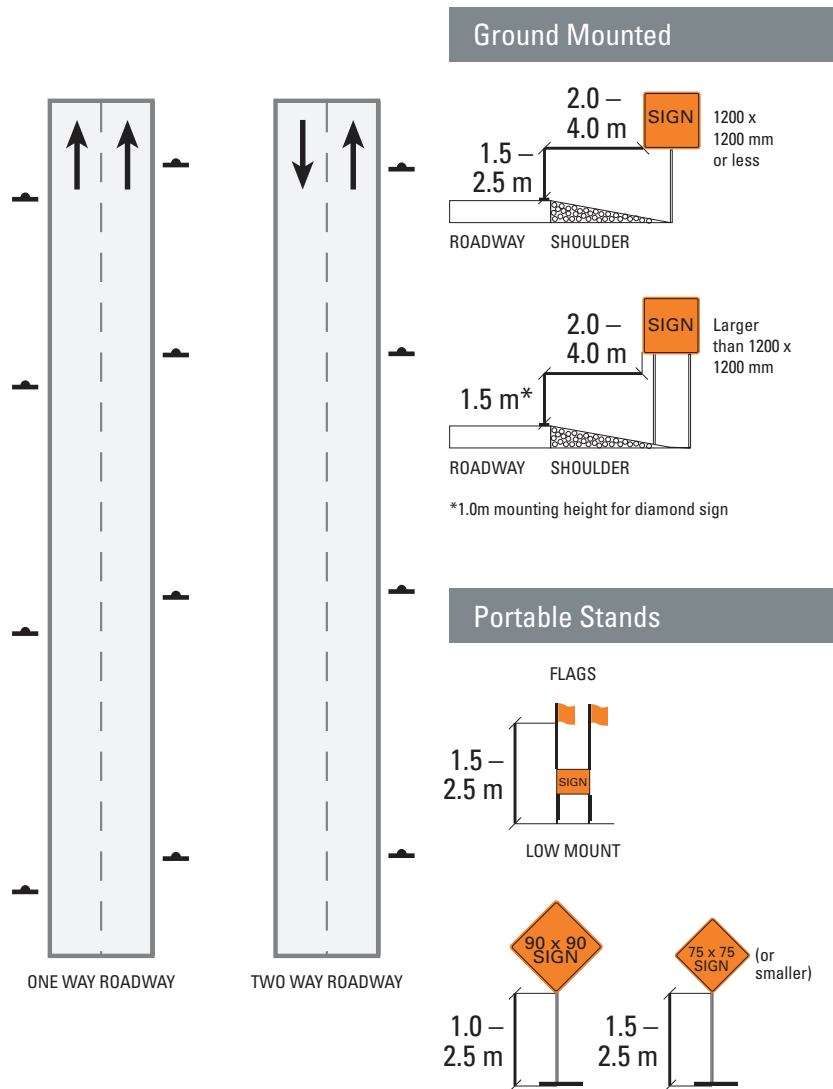

The objective is to place the signs in the driver's cone of vision.

All work zone signs are important. The location and maintenance of all regulatory signs need to be given high priority. **STOP/YIELD signs must always be maintained and be visible. They must be properly located and relocated as necessary through the various stages of construction or maintenance to ensure that the desired, intended right-of-way control is always in effect.**

- All temporary signs must be removed or covered immediately after they are no longer applicable.
- Permanent signs must be in place at the completion of each work project.
- Signs that pertain to a moving operation (e.g., hot mix paving) must be shifted along the highway as the operation proceeds.
- Signs must be mounted at almost right angles to the direction of travel they are to serve, angled three to five degrees away from the highway. Adjustments to the height and distance requirements may have to be made to allow placement of signs in constricted urban areas.
- Sign supports placed in the clear zone adjacent to a highway must yield or break away upon impact to minimize hazards to motorists and not present an undue hazard to workers. Signs must not be mounted in, or on, weighted barrels (e.g., 45-gallon steel drums).
- Signs for construction projects on both freeways and non-freeways must either be installed on direct buried posts or mounted on bases with sufficient ballast that they will remain in position for the duration of the project.
  - Permanent type supports are preferable for long-term projects as well as for STOP and YIELD signs.
  - Sign supports or bases should be designed to be safe when impacted.
  - The ballast must not comprise a material and/or size, such as a piece of steel or block of concrete, that could be hazardous if struck by a vehicle.

**NOTE**

All temporary signs must be removed or covered immediately after they are no longer applicable.

## Ground-Mounted Signs

### Specifications for Small Temporary Ground Mounted Signs are as follows:

- Signs that are 1200 mm or less in width must be installed on single or double posts with the bottom edge of the sign at a height of 1.5 metres to 2.5 metres above the travelled portion of a highway.
- Signs that exceed 1200 mm in width must be installed on two posts at a general height of 1.5 metres above the travelled portion of a highway to the bottom edge of the sign, with the exception of the diamond-shaped two-post sign which shall have a minimum height of 1.0 metre.

- The lateral distance from the edge of a highway to the nearer edge of the sign must be from 2.0 metres to 4.0 metres on freeways (rural and urban) and highways in rural areas, and 0.3 metres to 2.0 metres on non-freeways in urban areas.

## Portable Stands

### Specifications for Portable Stands are as follows:

- Installed signs are usually positioned on the usable portion of a shoulder. The portable supports for these signs should be constructed in such a manner that they will not be a hazard to errant vehicles, yet sufficient to remain upright.
- Signs that are less than 900 mm in width must be installed at a height of 1.5 metres to 2.5 metres above a highway.
- Signs that are 900 mm or greater in width must be installed at a height of 1.0 metres to 2.5 metres above a highway.
- Low-mounted portable sign stands (e.g., A-frame type) may only be used for TC-2A ROAD WORK (short duration) or TC-21 TRAFFIC CONTROL PERSON AHEAD signs.
  - Signs mounted on these stands must have flags attached to them to bring the attention of drivers to the message on the sign.
  - The bottom of the flags should be approximately 1.5 metres to 2.5 metres from the ground.
  - The sign bases must be made of a sound material to adequately support the sign; however, the base should not be appreciably wider than the sign.
  - Ballast, if required, will help to prevent the sign from blowing over by the wind. The ballast must not comprise a material and/or size, such as a piece of steel or block of concrete, that could be hazardous if struck by a vehicle.
- Roll-up signs may be used; however, the specifications must conform to the sign specifications outlined in OTM Book 7 and OTM Book 2 (Sign Design, Fabrication, and Patterns) and they must be able to withstand the push/pull from vehicles in the environment they are to be used in (i.e., freeway, non-freeway, high volume of heavy vehicles).
- Signs may require ballast. Ballast is recommended to be made of water-resistant bags filled with small stone weighing no more than 12 kg for ergonomic considerations.

#### NOTE

Low-mounted portable sign stands (e.g. A-frame type) may only be used for TC-2A or TC-21.



For intermediate or large sign supports refer to OTM Book 3.

### 4.2.8.5 Individual Sign Specifications – Static Message Signs

Where standard or oversize sign sizes are not specifically prescribed for a highway cross section or type, refer to [Table 4.2 Minimum Dimensions of Work Zone Warning Signs](#).

Where only one size is given, it may be used for all highway cross sections or types.

#### Construction Ahead Signs

TC-1	TC-1A	TC-1B
CONSTRUCTION AHEAD	CONSTRUCTION AHEAD 1 KM	CONSTRUCTION AHEAD 2 KM
		
Minimum Background Reflectivity: High reflectivity micro-prismatic fluorescent (Type VII)		

#### Purpose

The CONSTRUCTION AHEAD signs provide advance warning of a work zone for LD operations and may also be used for SD work zones.

#### Conditions

- The TC-1 sign must be installed in advance of a work zone at the distance specified in the appropriate table ([Table A](#), [Table B](#), or [Table C](#): 'F') or as shown on the layouts.
- In urban areas with NPRS of 60 km/h or lower, the TC-1 sign is sufficient.
- In rural areas, a TC-1A sign must be added at a distance of 1 km in advance of the work zone.
- For freeways, TC-1A and TC-1B signs must be installed at distances of 1 km and 2 km from the work zone, respectively.
- On a divided highway, two TC-1 signs must be installed, one on each side of the approaching lanes.





- Additional TC-1 signs must be installed on intersecting highways in advance of the construction site at the distance specified in the appropriate table ([Table A](#), [Table B](#), or [Table C](#): 'F').
- In rural areas, a TC-1A sign must be added at a distance of 1 km in advance of the work zone.
- For freeways, TC-1A and TC-1B signs must be installed at distances of 1 km and 2 km from the work zone, respectively.
- On a divided highway, two TC-1 signs must be installed, one on each side of the approaching lanes.
- Additional TC-1 signs must be installed on intersecting highways in advance of the construction site at the distance specified in the appropriate table ([Table A](#), [Table B](#), or [Table C](#): 'F').
- On major intersecting highways, the TC-1 sign must be preceded by a TC-1A sign 1 km in advance of the work zone on the crossing highway.

An additional TC-1 sign should be installed on an on-ramp where the acceleration lane ends within 400 m of the beginning of the lane closure taper.

**Size**

- **900 mm x 900 mm (standard)**
- **1200 mm x 1200 mm (oversized)** - See [Table 4.2](#)

**Road Work Signs**

TC-2A	TC-2B
ROAD WORK (short duration)	ROAD WORK (short and long duration)
	
Minimum Background Reflectivity: High reflectivity micro-prismatic fluorescent (Type VII)	

**Purpose**

The ROAD WORK sign inform highway users that workers are present.

## Conditions



- TC-2A or TC-2B signs must be:
  - Installed as indicated in the layouts.
  - Removed, covered, or dismantled and placed face down when workers are not present.
  - Used at multiple locations within long construction zones whenever and wherever workers are present.
  - Located on the shoulder or the curb in full view of approaching traffic.
  - Installed at a distance from the work area at the distance specified in the appropriate table ([Table A](#), [Table B](#), or [Table C](#): 'F') found in [Section 6](#).
- TC-2A signs must be:
  - Mounted on portable stands with flagpoles and opaque fluorescent orange flags 450 mm x 450 mm in size, at a height of 1.5 m to 2.5 m above the ground.
- TC-2B signs must be:
  - Installed on single or double posts when maintenance or minor construction activity extends over longer periods of time and is of a more stationary nature.

When the TC-21 TRAFFIC CONTROL PERSON AHEAD sign is used, ROAD WORK signs must be located at the same distance as defined above, in advance of the TC-21 sign.

## Size

**900 mm x 900 mm**

**Lane Closed Ahead Signs**

TC-3R	TC-3L
RIGHT LANE CLOSED AHEAD	LEFT LANE CLOSED AHEAD
	
Minimum Background Reflectivity: High reflectivity micro-prismatic fluorescent (Type VII)	

**Purpose**

TC-3R RIGHT LANE CLOSED AHEAD or TC-3L LEFT LANE CLOSED AHEAD signs must be used to provide advance warning of a closed lane.





**Conditions**

- The signs must be installed in advance of the TC-4 LANE CLOSURE ARROW sign at the distance specified in the appropriate table ([Table A](#), [Table B](#), or [Table C](#): 'F') and as shown in the layouts.
- When more than one lane is closed a TC-3 must be installed in advance of each lane closure.
- On a divided highway, two TC-3 signs must be installed, one on each side of the approaching lanes.

**Size**

**900 mm x 900 mm**

**Lane Closed Tab Signs**

TC-3Lt	TC-3Ct	TC-3Rt	TC-3tA
LEFT LANE CLOSEDTAB	CENTRE LANE CLOSEDTAB	RIGHT LANE CLOSEDTAB	300 mTAB
			
Minimum Background Reflectivity: High reflectivity micro-prismatic fluorescent (Type VII)			

**Purpose**

The TC-3Lt LEFT LANE CLOSED, TC-3Ct CENTRE LANE CLOSED, TC-3Rt RIGHT LANE CLOSED, and tab signs may be used for:

- “Left”, “Centre”, and “Right” lane closures, respectively, with the appropriate reversal of the sign symbol layout.



**Conditions**

- The supplementary tab sign (TC-3t) may be used where, due to vertical curvature or other reasons such as queuing anticipated beyond the TC-3 signs, the start of the lane reduction is not visible in advance for a sufficient distance.
- The TC-3tA tab sign may be used with other signs and distances where appropriate.

**Size**

- **TC-3\_t - 600 mm x 600 mm**
- **TC-3tA**
  - **300 mm x 600 mm (standard)**
  - **450 mm x 900 mm (oversized)**

## Lane Closure Arrow Signs

TC-4L	TC-4R
LANE CLOSURE ARROW	LANE CLOSURE ARROW
	
Minimum Background Reflectivity: High reflectivity micro-prismatic fluorescent (Type VII)	

### Purpose

The LANE CLOSURE ARROW signs inform highway users to merge into an adjacent open lane or on a partial lane shift.



### Conditions

- The TC-4 sign must be installed at or just beyond the beginning of a lane closure taper.
- The TC-4 sign must not be placed where it will direct vehicles into a lane with opposing traffic flow.
- On freeways, the TC-4 sign must be used together with the TC-3 LANE CLOSED AHEAD sign.
- May be enhanced with an amber beacon where shown in the layouts.

### Size

- **900 mm x 900 mm (standard)**
- **750 mm x 750 mm** - truck-mounted TC-4 may be used for SD work where the NPRS is 60 km/h or lower.
- **1200 mm x 1200 mm (oversized)** - must be used on multi-lane highways for LD work and NPRS of 70 km/h or higher. In urban areas, the standard size sign may be used if space does not permit the oversized sign.
- **1200 mm x 1200 mm (oversized)** - must be used on freeways.

**Detour Ahead Signs**

TC-5	TC-5A	TC-5B
DETOUR AHEAD	DETOUR AHEAD 1 km	DETOUR AHEAD 2 km
		
Minimum Background Reflectivity: High intensity (Type III)		

**Purpose**

The DETOUR AHEAD signs provide advance warning of a detour.

**Conditions**



- The TC-5, TC-5A, and TC-5B signs must be installed where:
  - A TC-7 is used to indicate a route detour.
  - One direction of a divided highway detours across the median and travels in a lane of the opposing direction (where space permits).
- Two TC-5, two TC-5A, and two TC-5B signs must be installed if the highway is divided, one of each on either side of the approaching lanes.
- The TC-5 sign must be installed in advance of the detour information signs (TC-64 to TC-67 and TC-10) at the distance specified in the appropriate table ([Table A](#), [Table B](#), or [Table C](#): 'F') and as shown in the layouts.
- The TC-5A sign is to be positioned 1 km in advance of the detour and TC-5B is positioned 2 km in advance of the detour.

**Size**

- **900 mm x 900 mm (standard)**
- **1200 mm x 1200 mm (oversized)** - must be used on multi-lane highways. In urban areas, the standard size sign may be used if space does not permit the oversized sign for SD work and where NRPS is 60 km/h or lower.
- **1200 mm x 1200 mm (oversized)** - must be used on a divided non-freeway, one on each side of the approaching lanes. On a narrow median, the standard size sign may be used if space does not permit the oversized sign.

- **1800 mm x 1800 mm (oversized)** -must be used on a freeway, one on each side of the approaching lanes. On a narrow median, if space does not permit, the 1200 mm x 1200 mm size sign may be used.

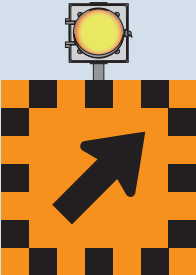
**Detour-Turn Off/Diversion Signs**

TC-7	TC-7tA	TC-7tB
DETOUR-TURN OFF/ DIVERSION	ROAD CLOSED TAB	LOCAL TRAFFIC ONLY TAB
		
Minimum Background Reflectivity: High intensity (Type III)		

**Purpose**

The DETOUR-TURN OFF/DIVERSION, ROAD CLOSED TAB, and LOCAL TRAFFIC ONLY tab signs indicate a highway closure or route detour, as illustrated on the sign layouts.



**Conditions**

- Due to its large size, the TC-7 sign must be mounted on stands at a height of 1.2 m from the pavement level to the bottom edge of the sign (rather than the normal minimum of 1.5 m).
- An amber beacon visible for a minimum distance of 150 m must be used in conjunction with this sign, exposed and continuously kept in flashing operation from sunset until sunrise, except where the flashing light would cause confusion if the sign is used near a signalized intersection.
- A TC-7tA tab sign should be used as a separate tab when:
  - A highway is physically closed, and an alternative route must be taken. Note: See Sections 28(3) and 102(3) of the Public Transportation and Highway Improvement Act R.S.O.1990.
  - Access is permitted to an area beyond the TC-7 DETOUR TURN OFF/DIVERSION sign or TC-7tA ROAD CLOSED tab.

**Size**

- **TC-7:**
  - **1200 mm x 1200 mm (standard)** – for urban non-freeways only.
  - **2100 mm x 2100 mm (oversized)** –on rural non-freeways and freeways.
- **TC-7tA:**
  - **250 mm x 1200 mm (standard)** – for urban non-freeways only.
  - **250 mm x 2100 mm (oversized)** –on rural non-freeways and freeways.
- **TC-7tB:**
  - **250 mm x 1200 mm (standard)** – for urban non-freeways only.
  - **250 mm x 2100 mm (oversized)** –on rural non-freeways and freeways.

**Roadside Diversion Warning Signs**

TC-9R	TC-9R(2)	TC-9R(3)
ROADSIDE DIVERSION WARNING	ROADSIDE DIVERSION WARNING	ROADSIDE DIVERSION WARNING
		
Minimum Background Reflectivity: High reflectivity micro-prismatic fluorescent (Type VII)		

**NOTE**  
TC-9L(#) mirror image, not shown

**Purpose**

The ROADSIDE DIVERSION WARNING signs are installed at locations where traffic is diverted within the right-of-way around work areas.

**Conditions**

- Must be installed at locations where traffic is diverted around work areas, largely or entirely within the highway right-of-way and indicates the vehicle path to be followed.





- For diversions over 1 km, use TC-16E (curve sign) at the beginning and end of the diversion to indicate vehicle path
- Where the diversion has more than one lane, a sign with the appropriate number of arrows (one arrow per lane) may be used to indicate to drivers that the highway lanes are continuous through the diversion. If a sign with more than one arrow is used, the number of arrows on the sign must match the number of lanes on the highway.
- The sign must be installed in advance of the highway diversion at the distance specified in the appropriate table ([Table A](#), [Table B](#), or [Table C](#): 'F') and as shown in the layouts.
- If the highway is divided, two signs must be installed, one on each side of the approaching lanes.

**Size**

- **750 mm x 750 mm one lane (standard)** for non-freeway.
- **900 mm x 900 mm two lane (standard)** for non-freeway.
- **1200 mm x 1200 mm three lane (standard)** for non-freeway.
- **900 mm x 900 mm one lane (oversized)** for freeway.
- **1200 mm x 1200 mm two lane (oversized)** for freeway.
- **1200 mm x 1200 mm three lane (standard)** for freeway.

**Detour Designation Signs**

TC-10	TC-10t	TC-10AR	TC-10BR
TC-10C	TC-10D	TC-10ER	TC-10FR

TC-10BRr	TC-10ALr	TC-10Cr
		
Minimum Background Reflectivity: High reflectivity micro-prismatic fluorescent (Type VII)		

**NOTE**  
 TC-10\_L mirror image, not shown.

**Purpose**

The DETOUR DESIGNATION and MARKER signs indicate an alternate route for traffic to follow where construction activities require total or partial closure of highways or streets, and signed detour routes are required to handle traffic.

**Conditions**

- The TC-10 DETOUR DESIGNATION sign must be used as a tab with a TC-66 HIGHWAY SECTION CLOSED or TC-67 STREET SECTION CLOSED sign in order to provide highway users with advance warning of the detour and inform them of the signs they are required to follow.
- The detour route must be given a “Detour Route Number” to clearly indicate the route that motorists are required to follow and minimizes confusion for other motorists who are not following the detour route.

**Size**

**TC-10:**

- **600 mm x 1200 mm (standard)**
- **1200 mm x 2400 mm (oversized)** – must be used on freeways

**TC-10 (t,A,B,C,D,E,F):**

- **450 mm x 450 mm trapezoid (standard)**
- **600 mm x 600 mm trapezoid (oversized)** – must be used on freeways, (900 mm x 900 mm option on freeways)

- **300 mm x 450 mm arrow (standard)**
- **450 mm x 600 mm arrow (oversized)** – must be used on freeways, (600 mm x 900 mm option on freeways)

**Narrow Lanes Sign**



**Purpose**

The NARROW LANES signs warn drivers on multi-lane highways that they are approaching a work area where lane widths have been reduced due to work operations.

**Conditions**

- In addition to the sign, old pavement markings should be removed or covered, and temporary solid edge lines and lane lines should be provided.

**Size**

- **900 mm x 900 mm**

**Trucks Use Centre Lane Tab Signs**

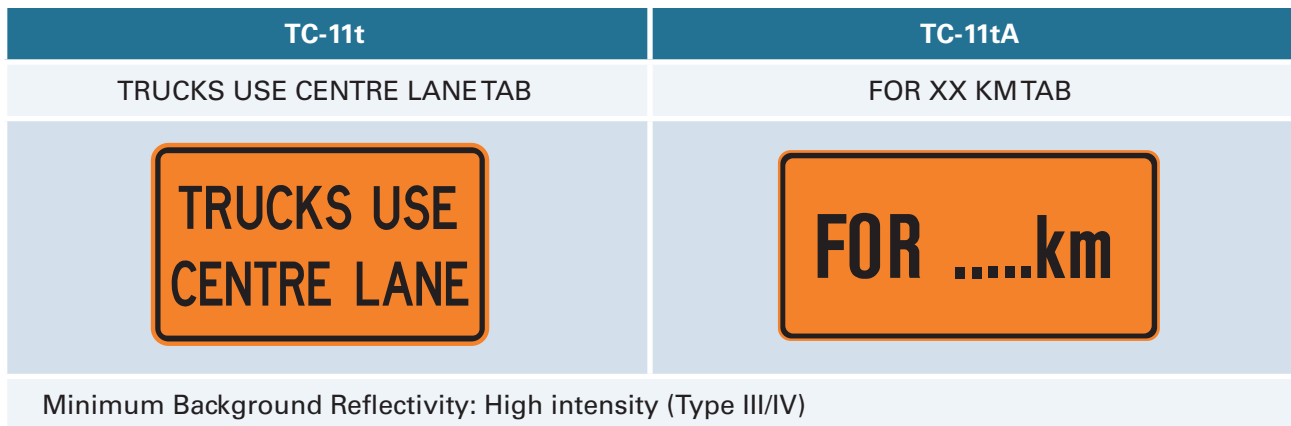

## Purpose

The TRUCKS USE CENTRE LANE and TAB signs advise truck drivers on which lane they should use (e.g., centre, right, or left), where lanes have been narrowed and the designated lane is the widest or preferred lane for trucks to use.

## Conditions

- The TC-11t is used where lanes have been narrowed and the designated lane is the widest or preferred lane for trucks to use (e.g. left, centre, right)
- The supplementary TC-11tA tab sign may be used to advise drivers of the length of highway for which the narrow lane condition exists.
- The TC-11tA tab sign may be used with other signs where it is considered desirable to advise drivers of the length of a given work zone or condition.

## Size

- TC-11t:
  - **450 mm x 750 mm**
- TC-11tA:
  - **300 mm x 600 mm (standard)**
  - **450 mm x 900 mm (oversized)** – must be used on freeways

## Pavement Ends Sign

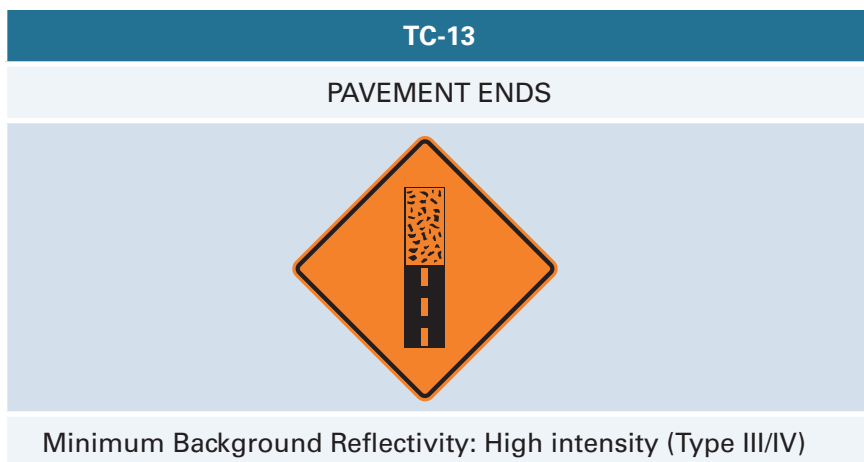

## Purpose

The PAVEMENT ENDS sign indicates where the pavement ends and changes to a gravel surface due to highway work.



**Conditions**

- The sign must be installed in advance of the pavement end point at the distance specified in the appropriate table ([Table A](#), [Table B](#), or [Table C](#): 'F') and as shown in the layouts.
- To be used only if the gravel surface extends for more than 10 m.
  - For distances less than 10 m, a TC-15 BUMP sign should be used.

**Size**

**900 mm x 900 mm**

**Bump Ahead Signs**

TC-14	TC-15
BUMP AHEAD	BUMP
	
Minimum Background Reflectivity: High intensity (Type III/IV)	

**Purpose**

The BUMP AHEAD and BUMP signs give warning of a sharp change in the profile of the highway that is sufficiently abrupt to create a hazardous discomfort to passengers, cause a shifting of cargo, or deflect a vehicle from its intended course when the bump is crossed at the posted speed limit.







**Conditions**

- The TC-15 sign must be installed adjacent to the bump and removed as soon as the highway deficiency no longer exists.
- The TC-14 sign must be located in advance of the TC-15 sign, at a distance taken from the appropriate table ([Table A](#), [Table B](#), or [Table C](#): 'F'), and must be removed as soon as the highway deficiency no longer exists.
- The TC-14 sign may not be required in low speed urban areas

**Size**

**600 mm x 600 mm**

**Turn and Curve Signs**

TC-16AL	TC-16BL	TC-16CL	TC-16DL
TURN	SHARP CURVE	CURVE	SHARP REVERSE CURVE
			
TC-16EL	TC-16EL(2)	TC-16EL(3)	
REVERSE CURVE (ONE ARROW)	REVERSE CURVE (TWO ARROWS)	REVERSE CURVE (THREE ARROWS)	
			

Minimum Background Reflectivity: High reflectivity micro-prismatic fluorescent (Type VII)

**NOTE**

TC-16\_R(#) mirror image, not shown

**Purpose**

The TURN AND CURVE warning signs indicate a sharp curve or turn in the vehicle path to be followed due to physical curvature of the highway.

**Conditions**

- Any existing warning signs (yellow background) do not need to be replaced by the orange signs.
- The TC-16E REVERSE CURVE sign must be used where two curves in opposite directions are separated by a tangent of less than 120 m.

- A TC-16ER RIGHT REVERSE CURVE sign must be used if the first curve is to the right.
- A TC-16EL LEFT REVERSE CURVE sign must be used if the first curve is to the left.

### Size

- One Lane:
  - 600 mm x 600 mm (standard)
  - 750 mm x 750 mm (oversized)\*
- Two Lanes:
  - 750 mm x 750 mm (standard)
  - 900 mm x 900 mm (oversized)\*
- Three Lanes:
  - 900 mm x 900 mm (standard)
  - 1200 mm x 1200 mm (oversized)\*

\* In general, the oversized curve warning signs must be used in rural areas and on all highway sections where higher operating speeds (70 km/h) can be safely maintained. Where there are severe space restrictions in urban areas and low observed vehicle speed conditions prevail, the smaller curve warning signs may be used. The oversized sign must be used on freeways.

### Advised Speed Tab Sign

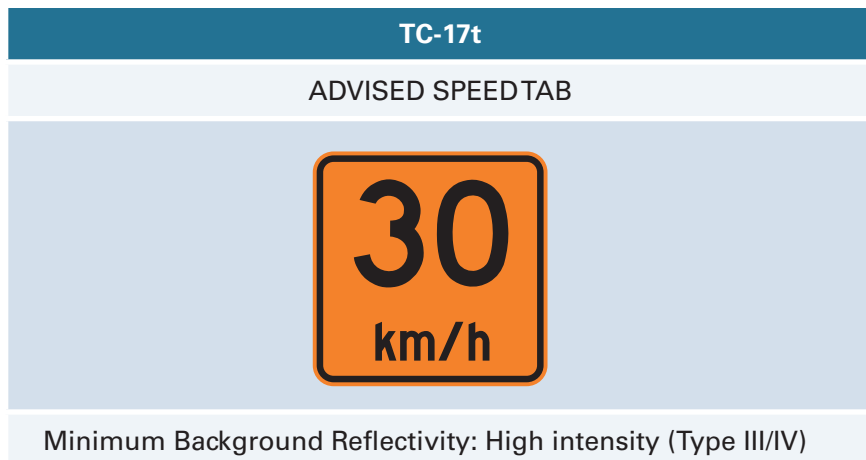

### Purpose

The ADVISED SPEED tab signs indicate an advised speed limit reduction.

**Conditions**

- The TC-17t sign should only be displayed where the safe speed has been determined by the use of a ball bank indicator (or equivalent method) in accordance with the procedure outlined in OTM Book 6 (Warning Signs).
- If necessary, the TC-17t sign can be mounted below the primary TC-9 ROADSIDE DIVERSION WARNING and TC-16A to 16E TURN AND CURVE signs.

**Size**

- 450 mm x 450 mm

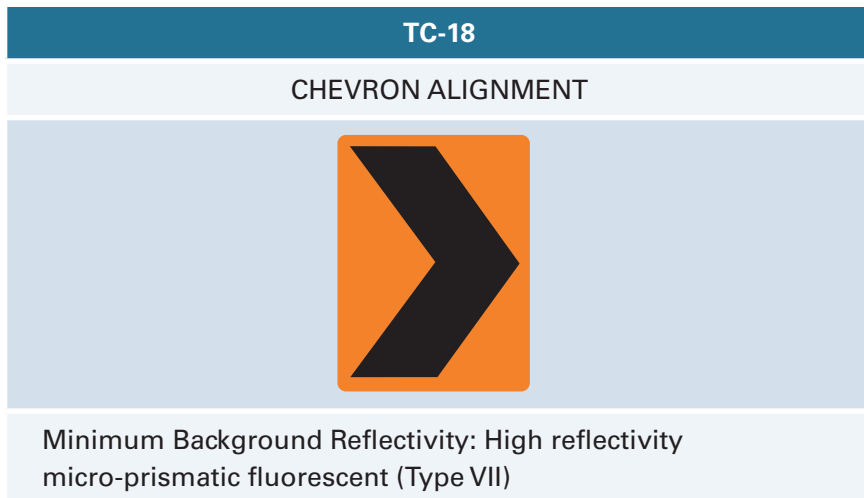
**Chevron Alignment Sign****Purpose**

The CHEVRON ALIGNMENT signs provide additional guidance where there are changes in the horizontal alignment in the highway. See also OTM Book 6 (Warning Signs) and OTM Book 11 (Pavement, Hazard and Delineation Markings).

**Conditions**

- TC-18 may only be installed on the outside of a curve or sharp turn and only where such a warning is essential.
- TC-18 must normally be located at right angles to oncoming traffic, but not in a way that is misread by opposing traffic.
- As sight conditions will vary, the spacing of the signs should be determined by a field investigation.
- All signs used at a location must be the same size and spacing of the signs should be such that the motorist always has two signs in view until the change in alignment eliminates the need for the signs.





- Where used, there must be a minimum of four TC-18 signs.
- The signs should be installed at a height of 1.2 m to 1.5 m above the edge of the nearest traffic lane to the bottom of the sign. Otherwise, they are to be installed in accordance with the general spacing requirement of OTM Book 6, or in OTM Book 11.

**Size**

- **450 mm x 600 mm (standard)**
- **600 mm x 750 mm (oversized)** - must be used on freeways.

**Grooved Pavement Signs**

TC-19	TC-19t
GROOVED PAVEMENT	GROOVED PAVEMENT TAB
	
Minimum Background Reflectivity: High intensity (Type III/IV)	

**Purpose**

The GROOVED PAVEMENT signs provide warning to highway users, including motorcyclists, where the pavement surface has been milled or grooved.

**Conditions**



The TC-19 sign must be installed in advance of:

- The point where the grooved or milled pavement surface begins.
- The smooth pavement endpoint at the distance specified in the appropriate table ([Table A](#), [Table B](#), or [Table C](#): 'F').
- The supplementary TC-19t tab sign may be used with the TC-19 sign for an educational period.

**Size**

- **TC-19 - 900 mm x 900 mm**
- **TC-19t - 450 mm x 750 mm**

**Prepare to Stop Signs**

TC-20	TC-20A	TC-20At
PREPARE TO STOP	PREPARE TO STOP (WITH AMBER FLASHERS)	WHEN FLASHING TAB
		
Minimum Background Reflectivity: High intensity (Type III/IV)		

**Purpose**

The PREPARE TO STOP, PREPARE TO STOP (with amber flashers) and the WHEN FLASHING tab signs where there is a high probability or certainty that motorists will have to stop for work operations, or recurring congestion which results in stop and go traffic.

**Conditions**

- The PREPARE TO STOP sign should be placed in advance of the expected stopping location at a distance specified in the appropriate table ([Table A](#), [Table B](#), or [Table C](#): 'F').
- The sign must be covered or removed in periods when there is not a high expectation or certainty of having to stop.
- The TC-20A PREPARE TO STOP sign with two amber flashers, one on each side of the sign, alternating in a “side to side” manner, must be used together with the TC-20At tab sign.
- TC-20A with TC-20At may be used instead of the TC-20 sign at work operations:
  - Necessitating periodic traffic stops that can be signalled to motorists, and where the visibility of the operation and/or the need to stop is otherwise poor.
  - Where motorist visibility of congested end-of-queue conditions is poor, and the sign can be activated by a presence detector at such locations.
  - The amber flashers used with the TC-20A sign must not continuously flash, and only when triggered by an event or situation that will require a stop.

**Size**

- **TC-20 & TC-20A:**
  - 750 mm x 750 mm (standard)
  - 900 mm x 900 mm (oversized) - must be used on freeways
- **TC-20At:**
  - 450 mm x 750 mm (standard)
  - 600 mm x 900 mm (oversized) - must be used on freeways

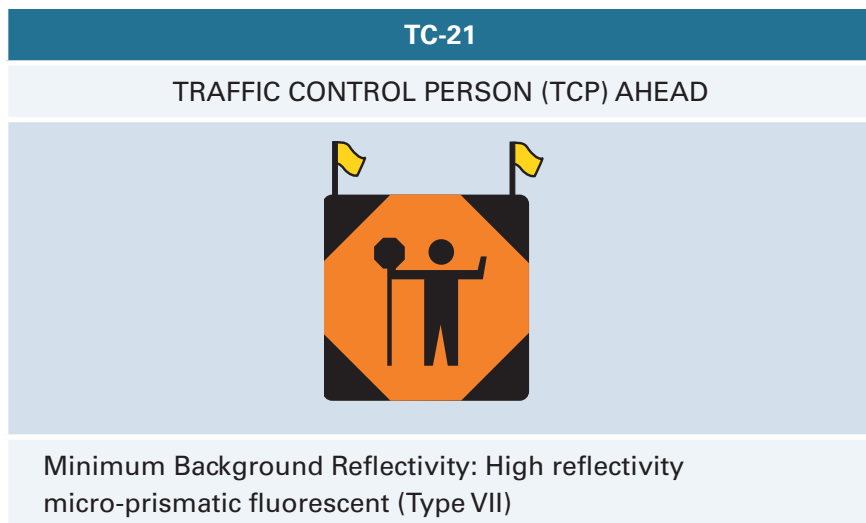
**Traffic Control Person (TCP) Ahead Sign****Purpose**

The TRAFFIC CONTROL PERSON (TCP) AHEAD signs alert highway users to the presence of TCP.

**Conditions**

The TC-21 sign must be:

- Used at all times when a TCP is on duty.
- Taken down when the TCP is not on duty.
- Placed in advance of the TCP at a distance specified in the appropriate table ([Table A](#), [Table B](#), or [Table C](#): 'F').
- Mounted on a portable stand with flagpoles and opaque fluorescent orange flags, 450 mm x 450 mm in size, mounted at a height of 1.5 m to 2.5 m above the ground.

**Size**

- **900 mm x 900 mm**

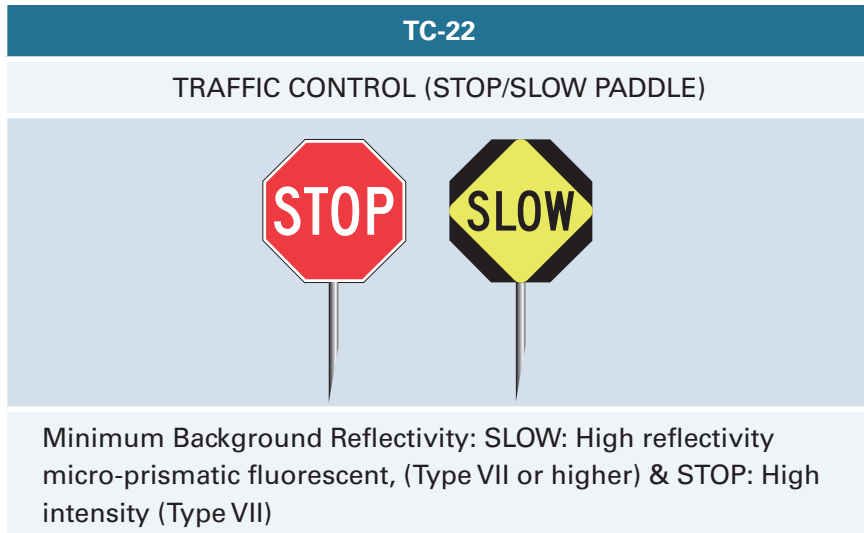
**Traffic Control Sign (STOP/SLOW Paddle)****Purpose**

The TRAFFIC CONTROL SIGN (STOP/SLOW Paddle) sign is a double-sided hand-held traffic sign that must be used by TCP to direct traffic.

**Conditions**

- TCP must signal the desired warning towards oncoming vehicles in accordance with the instructions detailed in [Section 4](#), and the training given by the highway authority or the contractor.
- If only one TCP is being used, the side of the sign that is not facing the intended direction of control must be covered in order not to confuse drivers in the opposing direction.
- The STOP side of the paddle may be enhanced with alternating flashing red LED lightbars installed horizontally and centered above and/or below the outer border of the STOP sign, as an option to the standard TC-22.
  - The alternating flashing red LED lightbar are to be briefly activated by the TCP as vehicles approach to enhance conspicuity.
- The TC-22 sign and its pole must meet the requirements of Ontario Regulation 213/91, Section 68 under the OHSA.

**Size**

- **450 mm x 450 mm (octagonal shape)**

## Signals Ahead Sign

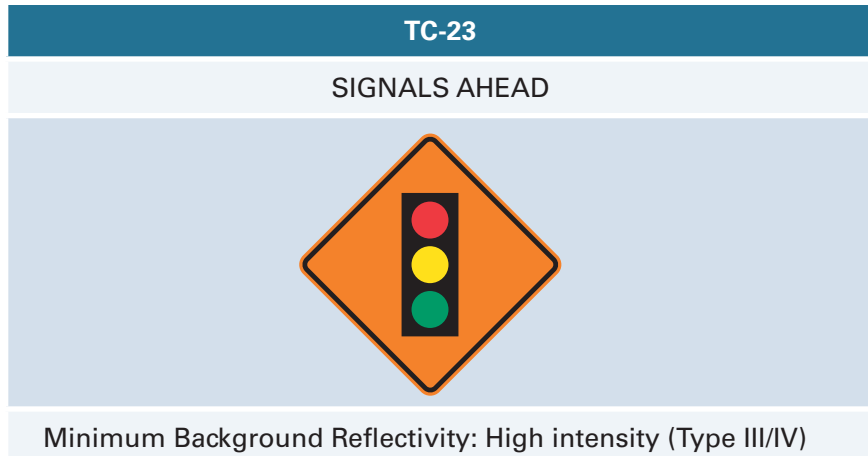

### Purpose

The SIGNALS AHEAD signs provide advance warning of temporary signal systems.



### Conditions

- The TC-23 sign must be used whenever the following signals are in use:
  - Portable lane control signals (PLCS).
  - Portable temporary traffic signals.
  - Temporary traffic signals.
- To be installed in advance of the signal system at a distance specified in the appropriate table ([Table A](#) or [Table B](#): 'F').
- Must be removed or covered when the signal system is not in operation.

### Size

- **600 mm x 600 mm (standard)**
- **750 mm x 750 mm (oversized)**

**Automated Flagger Assistance Device (AFAD) Ahead Signs**

TC-23B	TC-23At
REMOTE CONTROL DEVICE AHEAD	PREPARE TO STOP TAB
	
Minimum Background Reflectivity: High intensity (Type III/IV)	

**Purpose**

The TC-23B AUTOMATED FLAGGER ASSISTANCE DEVICE AHEAD and the TC-23At PREPARE TO STOP tab signs must be used to provide advance warning of an Automated Flagger Assistance Device (AFAD).

**Conditions**

- To be installed in advance of the AFAD at a distance specified in the appropriate table ([Table A](#) or [Table B: 'F'](#)).
- Must be removed or covered when the AFAD is not in operation.
- The TC-23At tab sign must be used with the TC-23B sign

**Size**

- **TC-23B:**
  - 600 mm x 600 mm (standard)
  - 750 mm x 750 mm (oversized)
- **TC-23At:**
  - 450 mm x 750 mm

**Uneven Lanes Sign**

TC-24
UNEVEN LANES

Minimum Background Reflectivity: High intensity (Type III)

### Purpose

The UNEVEN LANES signs should be used where there is a difference in elevation between adjacent lanes.

### Conditions

- Must be installed in advance of the point where the uneven pavement begins at the distance specified in the appropriate table ([Table A](#), [Table B](#), or [Table C](#): 'F').

### Size

- 750 mm x 750 mm (standard)
- 900 mm x 900 mm (oversized) - must be used on freeways.

### Do Not Pass When Flashing Sign

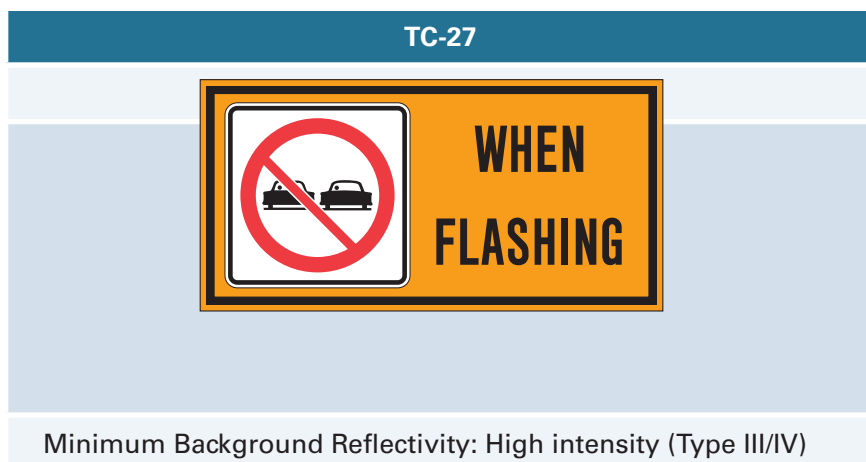

### Purpose

The TC-27 DO NOT PASS WHEN FLASHING sign must be used where a pilot vehicle or pace vehicle(s) is being used.



### Conditions

- Must be mounted on the rear of the pilot vehicle or pace vehicle(s), in plain view of the vehicles that are following.
- This sign is not required on police vehicles that are acting as pilot or pace vehicles.
- See [Section 4.4.4](#) on the use of pilot vehicles, pace vehicles, and rolling closures.

### Size

- 750 mm x 1500 mm

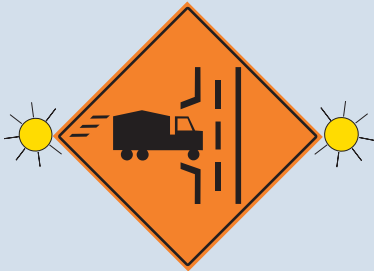
**Truck Entrance Signs**

TC-31L	TC-31A	TC-20At
TRUCK ENTRANCE	TRUCK ENTRANCE (WITH AMBER FLASHERS)	WHEN FLASHING TAB
		
Minimum Background Reflectivity: High intensity (Type III/IV)		

**Purpose**

The TC-31L TRUCK ENTRANCE, TC-31A TRUCK ENTRANCE (WITH AMBER FLASHERS), and TC-20At When Flashing tab signs must be used to warn of trucks entering highway.

**Conditions**



- Must be used when trucks are using an entrance from a work zone into a live lane (turn or crossing movement).
- Must be installed in advance of the crossing at the distance specified in the appropriate table ([Table A](#), [Table B](#), or [Table C](#): 'F').
- The truck entrance sign illustrates the truck entering the highway, not the work area.
- If the truck entrance is on the left, the TC-31L sign must be used. The TC-31R sign must be used when the truck entrance is on the right.
- Where the presence of a truck that is about to enter the highway is automatically detected, the TC-31A sign is used with two amber flashers, one on each side of the sign, alternating in a side-to-side manner, activated by the detector, so that the amber flashers provide a real time signal to motorists that a truck is about to enter the highway.
  - When the TC-31A sign is used, the TC-20At tab sign must also be used.
  - The flashers should not be continuously flashing; otherwise, they will lose their effectiveness.
  - Care must be taken to ensure that the detector system that is activating the flashers is intact and properly functioning.
- May also be used where the temporary condition limits the vision of an existing crossing that is heavily used by trucks (see OTM Book 6 (Warning Signs) for sight distance criteria).



**Size**

- **TC-31 & TC-31A:**
  - 900 mm x 900 mm
- **TC-20At:**
  - 600 mm x 900 mm

**Temporary Bridge Signs**

TC-32	TC-32t
TEMPORARY BRIDGE	TEMPORARY BRIDGE XXX KM/H TAB
	
Minimum Background Reflectivity: High intensity (Type III/IV)	

**Purpose**

The TC-32 TEMPORARY BRIDGE sign must be used to warn of a temporary bridge ahead, on which the traffic speed is severely reduced.



**Conditions**

- The TC-32 sign should be installed approximately 150 m in advance of the bridge.
- The TC-32t TEMPORARY BRIDGE XXX KM/H tab sign is not mandatory but may be used for an Advisory speed, to be determined by the highway authority.

**Size**

- **TC-32:**
  - 900 mm x 900 mm
- **TC-32t:**
  - 600 mm x 900 mm

**Low Bridge Ahead Signs**

TC-33	TC-33A	TC-33B
LOW BRIDGE AHEAD	LOW CLEARANCE AHEAD XX m	LOW CLEARANCE XX m
		
Minimum Background Reflectivity: High intensity (Type III/IV)		

**Purpose**

The TC-33 LOW BRIDGE AHEAD signs warn of an approaching low bridge to provide trucks with the opportunity to exit the highway.

**Conditions**

- TC-33 must be installed approximately 400 m in advance of the last exit that trucks can use to avoid low clearance in a construction area.
- TC-33 must only be used where the clearance of the structure is less than 4.5 m.
- As work progresses, clearance may change frequently, and trucks may not be confined to the normal travelled portion.
- Immediately after any action which modifies the clearance of the structure, the revised clearance should be accurately measured, and the clearance figures reported without any delay to the highway authority to determine the need for clearance signing.
- As an alternative to the TC-33 sign, where space is limited, and frequent opportunities exist to bypass a low bridge (e.g., urban areas), the TC-33A and TC-33B LOW CLEARANCE signs may be used.
- The black and orange TC-33A and TC-33B signs should only be used where low clearance is a result of work zone activities.
- The TC-33B sign is installed, if possible, on the structure just above the opening and over the centre of a highway, unless the clearance varies over the width of the structure; in which case, a second sign is installed to indicate the lesser clearance.
- Whenever possible, advance warning of the low clearance condition should be located to permit over-height vehicles to select an alternate route.

- Additional advance signing with a TC-3tA distance tab sign may be used for this purpose.
- If the low clearance is a permanent or semi-permanent condition, the black and yellow Wa-26 and Wa-27 LOW CLEARANCE signs should be used.

### Size

- **TC-33:**
  - **900 mm x 2400 mm**
- **TC-33A:**
  - **600 mm x 600 mm (standard)**
  - **900 mm x 900 mm (oversized)** - must be used on freeways
- **TC-33B:**
  - **600 mm x 900 mm**

### Two-Way Traffic Sign

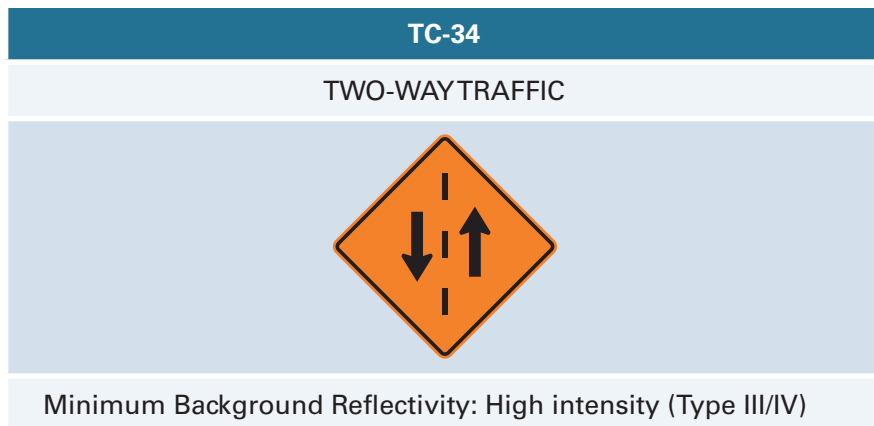

### Purpose

The TC-34 TWO-WAY TRAFFIC sign must be used to warn motorists who are driving on a one-way street or highway that they are approaching a section where two-way traffic flow is temporarily in operation.

### Conditions

- Must be installed in advance of the two-way traffic area at a distance specified in the appropriate table ([Table A](#), [Table B](#), or [Table C](#): 'F').
- The beginning of the two-way traffic flow must be marked by regulatory Rb-24 TWO-WAY TRAFFIC signs and additional Rb-24 reminder signs as appropriate. Refer to OTM Book 5 (Regulatory Signs).

**Size**

- 900 mm x 900 mm

**Ramp Closed Ahead Sign**

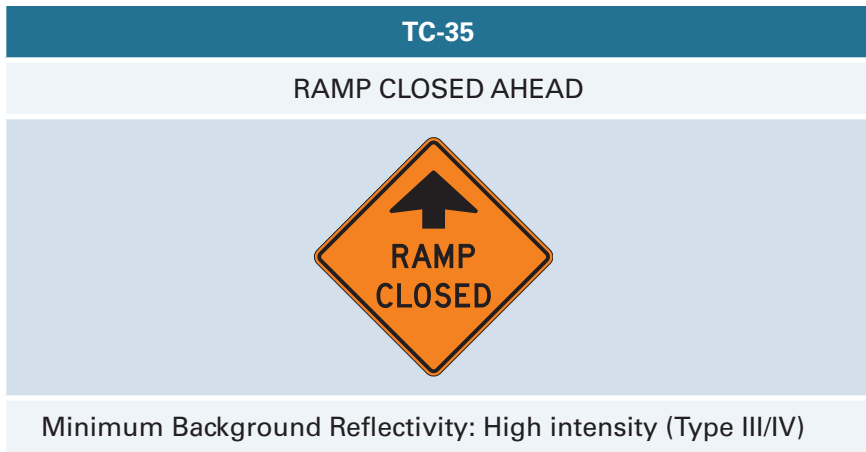

**Purpose**

The TC-35 RAMP CLOSED AHEAD signs warn drivers on a multi-lane street or highway that they are approaching an exit ramp which is temporarily closed.

**Conditions**

- Used for SD work and may be used to supplement LD signs, such as the TC-64 (Section 4.2.10).
- Installed in advance of the exit taper/deceleration lane (if present), or channelization, at a distance specified in the appropriate table ([Table A](#), [Table B](#), or [Table C](#): 'F').

**Size**

- 900 mm x 900 mm

**Maximum Speed Advisory Sign**

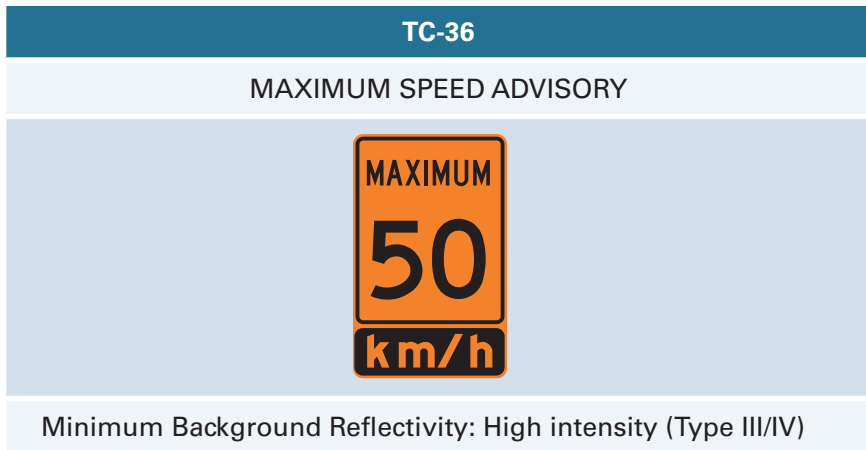

## Purpose

The MAXIMUM SPEED ADVISORY sign is to be used to warn drivers where a non-regulatory speed reduction is deemed necessary.

## Conditions

- Used whenever an unexpected change in geometrics is caused by the work activity, refer to [Table 3.9](#).
- Used where geometrics of the highway are not reduced due to construction, but public traffic is required to mingle with heavy grading or similar operations and is considered that a combination of advisory speed signing and proper procedures by TCP should be adequate provisions for the safe passage of traffic.
- Must not display the same speed as the posted regulatory speed sign.
- Should be installed:
  - Approximately 600 m apart for advisory speed zones up to 2 km long.
  - Approximately 1.5 km apart for advisory speed zones of longer distances.

## Size

- 600 mm x 900 mm

## Soft Shoulders Sign



## Purpose

The SOFT SHOULDER signs are used where soft shoulders present a hazard.

## Conditions

- Must be installed at regular intervals that are approximately 300 m apart over a 1 km stretch and 900 m apart on longer sections.

- Removed after the shoulders have become thoroughly compacted or are safe for low-speed traversal.

**Size**

- 600 mm x 600 mm

**No Exit Sign**



**Purpose**

The TC-39 NO EXIT signs warn drivers at the entrance to a highway that it temporarily has no outlet.

**Conditions**

TC-39 signs must be conspicuously posted on both sides of the entrance to the highway, either:

- Individually on separate posts, or
- Mounted on the barricade that is blocking the entrance.

**Size**

- 450 mm x 450 mm

**Pedestrian Direction Sign**

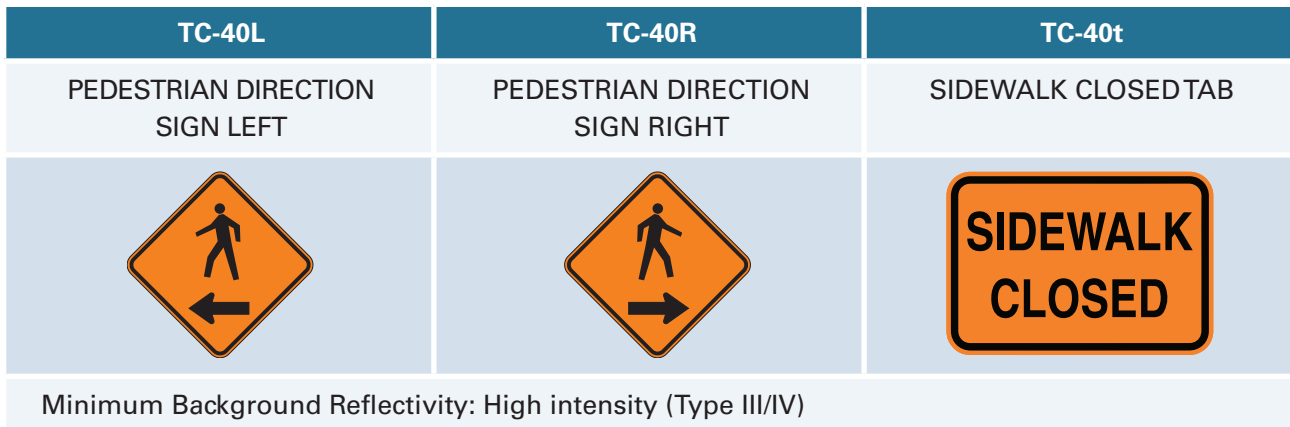

**Purpose**

The PEDESTRIAN DIRECTION SIGN and SIDEWALK CLOSED tab signs indicate to pedestrians the intended pathway through or around a work area.





**Conditions**

- Must be placed at locations that clearly mark the alternate pathway at all pedestrian decision points.
- The TC-40t is used only when the sidewalk is closed.

**Size**

- **TC-40L:**
  - 450 mm x 450 mm
- **TC-40R:**
  - 450 mm x 450 mm
- **TC-40t:**
  - 300 mm x 450 mm

**Bicycle Lane Detour Signs**

TC-41	TC-41L	TC-41R	TC-42
BICYCLE LANE DETOUR AHEAD	BICYCLE LANE DETOUR TURN OFF LEFT	BICYCLE LANE DETOUR TURN OFF RIGHT	BICYCLE LANE DETOUR ENDS
			

Minimum Background Reflectivity: High intensity (Type III/IV)

**Purpose**

The BICYCLE LANE DETOUR signs must be used to guide cyclists along a separate alternate route where work zone activities require the closure of a bicycle lane.

**Conditions**

- The TC-41 sign should be installed in advance of and at intersections to indicate to cyclists the direction of the detour route.
- A marker may be placed between intersections to confirm the detour route to the cyclist.
- The TC-42 sign should be installed at the end of the detour route.
- Where motorists and cyclists share the same detour route, separate detour signage for bicycles is not required.

**Size**

- **TC-41:**
  - 450 mm x 450 mm
- **TC-41L:**
  - 450 mm x 450 mm
- **TC-41R:**
  - 450 mm x 450 mm
- **TC-42:**
  - 450 mm x 450 mm

**Bicycle Lane Closed Sign**





**Purpose**

The BICYCLE LANE CLOSED sign must be used to warn cyclists that the reserved bicycle lane is temporarily closed.





**Conditions**

- The TC-43 sign should be accompanied by the appropriate TC-41 sign if a separate bicycle detour is provided.

**Size**

- 450 mm x 450 mm

**Share the Road Signs**

TC-101	TC-101t	TC-102	TC-102t
SHARE THE ROAD	SHARE THE ROAD TAB	SHARE USE LANE SINGLE FILE	SHARE USE LANE SINGLE FILE TAB
			
Minimum Background Reflectivity: High intensity (Type III/IV)			

**Purpose**

The SHARE THE ROAD signs caution all road users on the approach to locations where there may be a change in the road configuration that requires road users to share a lane.



**Conditions**

- The signs should be used in addition to the appropriate signs for the specific condition, where applicable.
- Consider TC-101 and TC-101t if the travel lane width is greater than 4.0 metres.
- Consider TC-102 and TC-102t if the travel lane width is less than 4.0 metres, and/or motorists are discouraged from passing cyclists.
- TC-101 and TC-102 may be supplemented with the optional sharrow marking.

**Size**

- **TC-101:**
  - **600 mm x 600 mm**
- **TC-101t:**
  - **300 mm x 600 mm**
- **TC-102:**
  - **600 mm x 600 mm**
- **TC-102t:**
  - **300 mm x 600 mm**

**Motor Vehicle Passing Prohibited Signs**

Rb-66	Rb-66t	M204
MOTOR VEHICLE PASSING PROHIBITED	DO NOT PASS BICYCLES	MARKERTAB - ENDS
		
Minimum Background Reflectivity: High intensity (Type III/IV)		

**Purpose**

The MOTOR VEHICLE PASSING PROHIBITED signs are used to restrict passing manoeuvres.

**Conditions**

- The Rb-66 and Rb-66t must be used where passing of cyclists is hazardous due to limited sign distance or other considerations.
- The Rb-66 sign must be used with the supplementary M204 sign to indicate the termination of the motor vehicle passing prohibited zone.
- Refer to OTM Book 5 (Regulatory Signs) and OTM Book 18 (Cycling Facilities)

**Size**

- **Rb-66:**
  - 600 mm x 600 mm
- **Rb-66t:**
  - 300 mm x 600 mm
- **M204:**
  - 300 mm x 600 mm

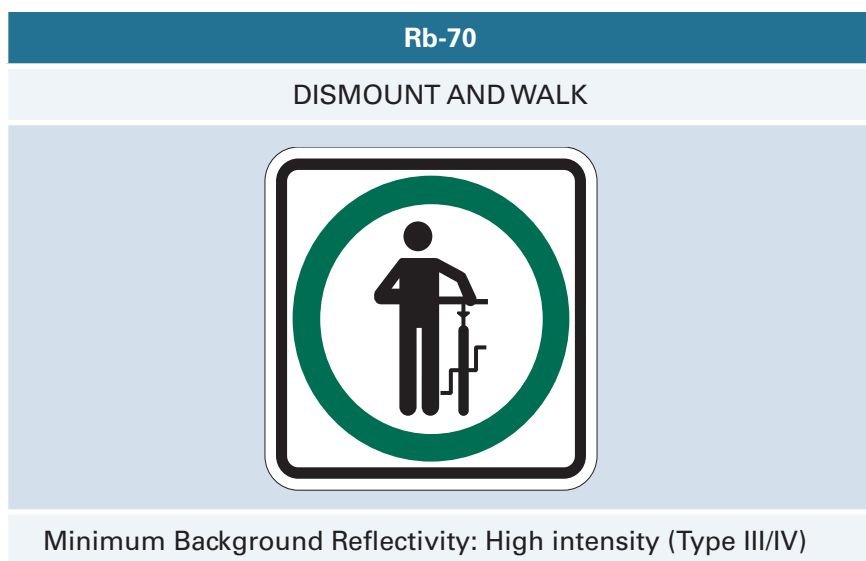
**Dismount and Walk Sign****Purpose**

The DISMOUNT AND WALK sign advises a cyclist to dismount and walk when entering a pedestrian facility.



**Conditions**

- Should be used only in exceptional cases, such as where an in-boulevard facility ends, and cyclists would discharge into a sidewalk or pedestrian zone.
- Refer to OTM Book 5 (Regulatory Signs) and OTM Book 18 (Cycling Facilities)

**Size**

- 300 mm x 300 mm

**Lane Designation Direction Sign**

TC-25L	TC-25R
LANE DESIGNATION DIRECTION	LANE DESIGNATION DIRECTION
	
Minimum Background Reflectivity: High intensity (Type III/IV)	

**Purpose**

The LANE DESIGNATION DIRECTION signs are used to indicate the vehicle path to be followed for a specified lane designation.

**Conditions**

- Must be used with the corresponding Lane Designation Sign (Rb-41 thru Rb-47), as shown in the Layouts.

**Size**

- 600 mm x 900 mm

**Speed Fines Doubled Sign**

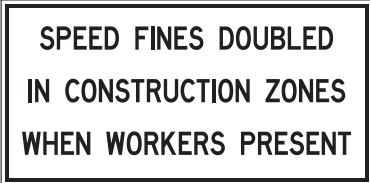
TC-90
SPEED FINES DOUBLED

Minimum Background Reflectivity: High intensity (Type III/IV)

**Purpose**

The SPEED FINES DOUBLED sign inform drivers of doubled fines for speeding in a designated construction zone.



**Conditions**

- The highway authority must establish and sign a designated construction zone for the doubled fines to be in effect.
- The TC-90 signs may be installed at regular intervals throughout a designated construction zone to encourage compliance with the posted regulatory speed limit, however, are not required for the doubled speed fines to be in effect.

**Size**

- **900 mm x 900 mm (standard)**
- **1200 mm x 2400 mm (oversized)**

**Construction Zone Signs**

Rb-90A	Rb-90B
CONSTRUCTION ZONE BEGINS	CONSTRUCTION ZONE ENDS
	
Minimum Background Reflectivity: High intensity (Type III/IV)	

**Purpose**

The CONSTRUCTION ZONE BEGINS and CONSTRUCTION ZONE ENDS signs indicate the limits of a designated construction zone.

**Conditions**

- The Rb-90A must be installed at the beginning of the designated construction zone.
- The Rb-90B must be installed at the end of the designated construction zone.
- The Rb-90A and Rb-90B signs must be in place in order for a reduced regulatory speed zone or speed fines doubled zone to be in effect.
- Refer to [Section 3.6.2](#) for designating a construction zone.

**Size**

- **600 mm x 900 mm**

**YIELD Sign**

Ra-2
YIELD

Minimum Background Reflectivity: High intensity (Type III/IV)

**Purpose**

The YIELD sign may be used where it is necessary to advise drivers of construction vehicles who are exiting from work areas into travelled traffic lanes that they must yield to traffic in those lanes.



**Conditions**

- The use of the Ra-2 YIELD sign for control of normal highway traffic is described in OTM Book 5 (Regulatory Signs).
- The Rb-91 YIELD TO ONCOMING TRAFFIC sign **must not** be used for this purpose.

**Size**

- 750 mm x 750 mm
- 900 mm x 900 mm (oversized)

**Yield to Oncoming Traffic Signs**

Rb-91	Wb-1A
YIELD TO ONCOMING TRAFFIC	YIELD AHEAD
	
Minimum Background Reflectivity: High intensity micro-prismatic (Type VII)	Minimum Background Reflectivity: Very high intensity micro-prismatic (Type IX/XI)

**Purpose**

The YIELD TO ONCOMING TRAFFIC signs advise highway users that they are required to give the right of way to oncoming traffic in a shared lane.

**Conditions**

- The Rb-91 sign must only be used on two-lane, two-way highways, where only one lane is available for traffic where:
  - Traffic volume is too low (less than 3,000 vehicles/day) to warrant the installation of a temporary traffic signal system or use of Traffic Control Persons (TCP).
  - The work area is shorter than 150 m.
  - There is unobstructed visibility of oncoming traffic in both directions.
- The sign must only be installed in the direction of the closed lane and located at a distance in advance of the lane closure specified in the appropriate table (Table A or B: 'F').
- The sign must be covered or removed when a TCP is on duty.
- A Wb-1A YIELD AHEAD sign should be used in conjunction with the Rb-91 sign where traffic is approaching at high speed and an advance warning for the one lane traffic control is considered essential.
- The use of the Wb-1A sign for the control of traffic is described in OTM Book 6 (Warning Signs).

**Size**

- **Rb-91:**
  - 900 mm x 1200 mm
- **Wb-1A:**
  - 750 mm x 750 mm
  - 900 mm x 900 mm (oversized)

**Do Not Use Radio Transmitter Signs**

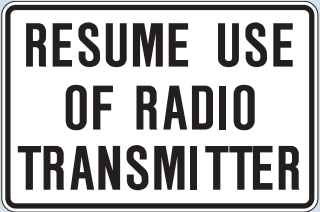
TC-44	TC-45
DO NOT USE RADIO TRANSMITTER	RESUME USE OF RADIO TRANSMITTER
	
Minimum Background Reflectivity: High intensity (Type III/IV)	

**Purpose**

The DO NOT USE RADIO TRANSMITTER and RESUME USE OF RADIOTRANSMITTER signs must be installed where blasting is being done, whenever an electrical detonating system is in use adjacent to a highway.

**Conditions**

- The TC-44 sign must be installed 1 km in advance of the blasting area.
- The TC-45 sign must be installed:
  - In conjunction with the TC-44 where blasting is being done.
  - 1 km past the end of the blasting area.

**Size**

- 600 mm x 900 mm

**Road Closed Sign**

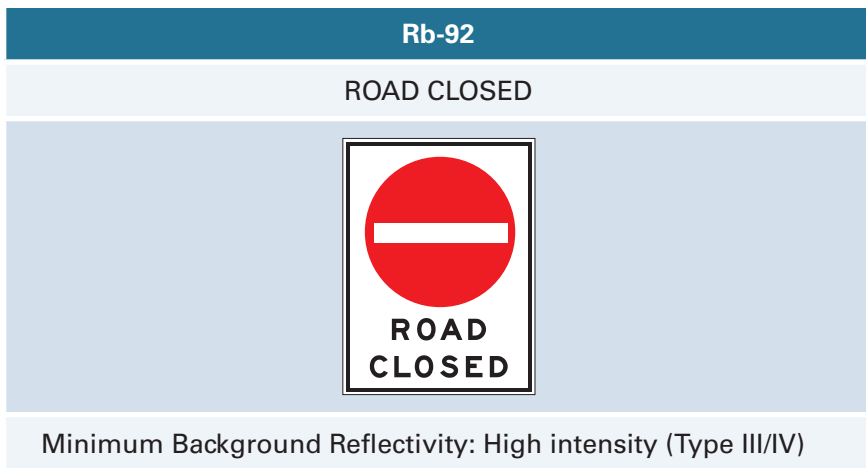

**Purpose**

The ROAD CLOSED sign must be used where a highway must be temporarily closed.

**Conditions**



- Requirements are detailed in OTM Book 5 (Regulatory Signs).
- Use of the Rb-92 must comply with Subsections 28(3) and 102(3) of the Public Transportation and Highway Improvement Act R.S.O. 1990.
- A ruling by the Ontario Land Tribunal on a highway closure must be precisely followed, and where these exist, full information should be obtained from the appropriate traffic authority.



**Size**

- 900 mm x 1200 mm

**Turn Control Signs**

Rb-10	Rb-11	Rb-12
NO STRAIGHTTHROUGH	NO RIGHTTURN	NO LEFTTURN
		
Minimum Background Reflectivity: High intensity (Type III/IV)		

**Purpose**

The TURN CONTROL signs are used to indicate the prohibition of specific turns or manoeuvres that are indicated symbolically on the signs using arrows and the red interdictory symbol.

**Conditions**

- The Rb-10, Rb-11, and Rb-12 signs are used at intersections.
- At unsignalized intersections, turn control signs must be mounted facing traffic approaching the intersection.
- At signalized intersections, turn control signs must be mounted adjacent to the signal heads governing traffic to which they apply.

**Size**

- **Rb-10:**
  - 600 mm x 600 mm
- **Rb-11:**
  - 600 mm x 600 mm
- **Rb-12:**
  - 600 mm x 600 mm

**Keep Right or Keep Left Signs**

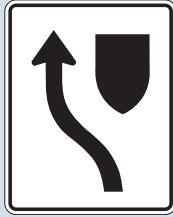
Rb-25R	Rb-25L
KEEP RIGHT	KEEP LEFT
	
Minimum Background Reflectivity: High intensity (Type III/IV)	

**Purpose**

The KEEP RIGHT and KEEP LEFT signs indicate to drivers that they must keep their vehicles to the right or left, respectively, of obstructions or roadway features.



**Conditions**



- Requirements are detailed in OTM Book 5 (Regulatory Signs).
- The Rb-25R and Rb-25L signs must be placed within 1.5 m of the upstream end of the obstruction facing motorists travelling towards the obstruction.

**Size**

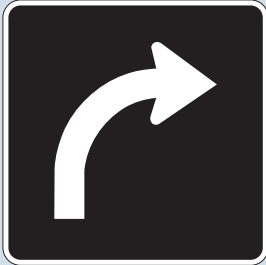
- 600 mm x 750 mm (standard)
- 600 mm x 900 mm (oversized)
- 900 mm x 1200 mm (special oversized)

**Turn Lane Designation Signs**

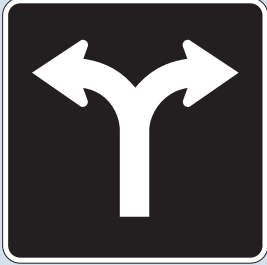
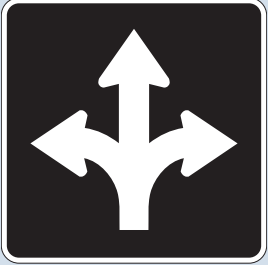
Rb-41	Rb-42	Rb-43	Rb-44
LEFT TURN ONLY	RIGHT TURN ONLY	STRAIGHT THROUGH OR LEFT TURN ONLY	STRAIGHT THROUGH OR RIGHT TURN ONLY
			

Rb-45	Rb-46	Rb-47
LEFT OR RIGHT TURN ONLY	ALL MOVEMENTS PERMITTED	STRAIGHT THROUGH ONLY
		
Minimum Background Reflectivity: High intensity (Type III/IV)		

**Purpose**

The TURN LANE DESIGNATION signs indicate permitted movements designated to each lane on the approach to an intersection.

**Conditions**

- Requirements are detailed in OTM Book 5 (Regulatory Signs).
- For ground-mounted applications, use standard size sign.
- For overhead applications, use oversized sign.

**Size**

- **600 mm x 600 mm (standard)**
- **900 mm x 900 mm (oversized)**

## 4.2.9 Typical Information Signs

TC-61 through TC-81 provide examples of typical information signs. The purpose of these signs, conditions for their use, and sizes are provided below.

Additional details regarding the use and specifications for information signs should be obtained from the road authority.

On provincial highways, regional Traffic should be contacted for signing requirements and further guidance can be found in the MTO Temporary Conditions Traffic Management: Advance Notification, Advance Warning and Alternative Route Signing.

**New Roadway Open Sign**

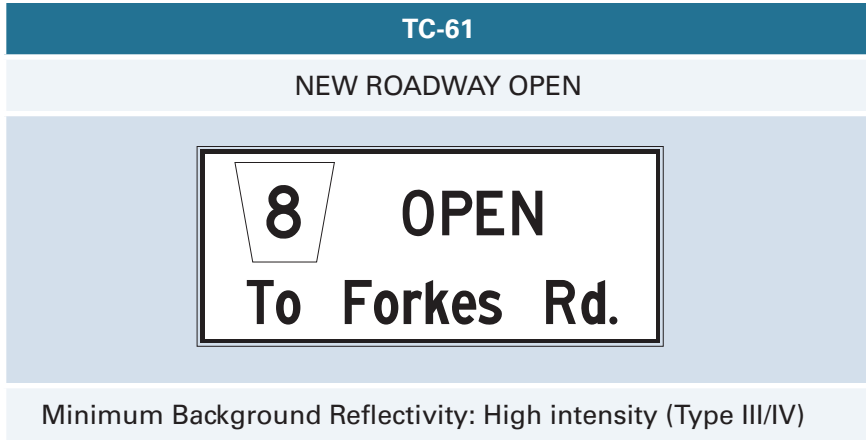

**Purpose**

The NEW ROADWAY OPEN sign informs potential users that a new highway is open.

**Conditions**

- Must be installed approximately 1 km in advance of the best alternative route and 1 km in advance of the beginning of the new highway section.
- Must be removed one year after installation.

**Size**

- 1200 mm x 2100 mm

**Alternate Highway Route Sign**

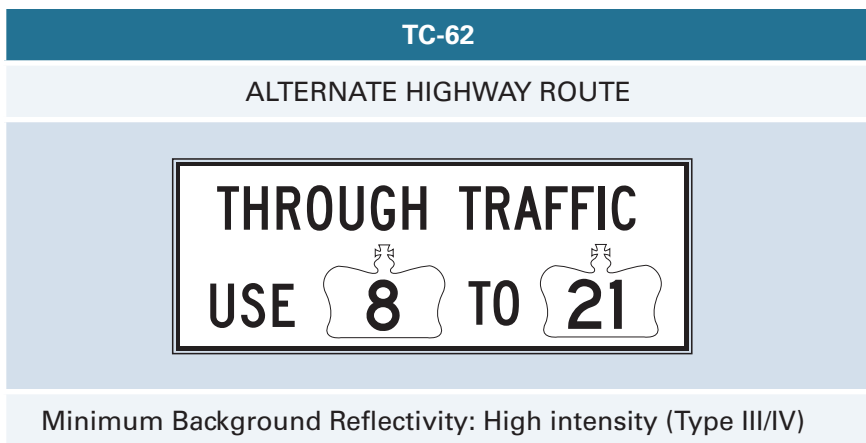

**Purpose**

The ALTERNATE HIGHWAY ROUTE sign indicates an alternate route around the closed area of a through highway and either designated by highway name or detour route.

**Conditions**

- Must be Installed 100 m beyond the TC-66 HIGHWAY SECTION CLOSED sign.

**Size**

- 1200 mm x 2400 mm

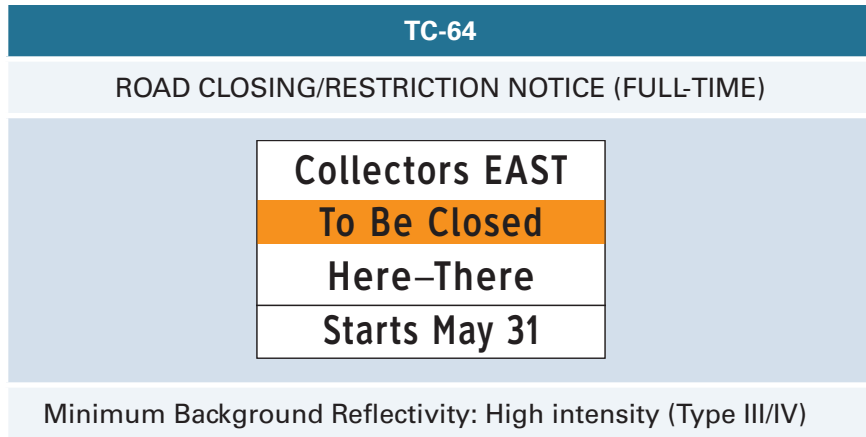
**Road Closing/Restriction Notice Sign (Full-Time)**

A general description of TC-64 is provided in [Section 4.2.10](#).

**Road Closing Notice Sign****Purpose**

The ROAD CLOSING NOTICE sign provides advance notice of a street which is to be closed or restricted on a temporary basis.

**Conditions**

- Must be installed at strategically selected locations of the street at least one week prior to the actual closing date of the street.
- Must be removed immediately after the street has been closed.

**Size**

- 1200 mm x 1200 mm

**Highway Section Closed Sign (Advance)**

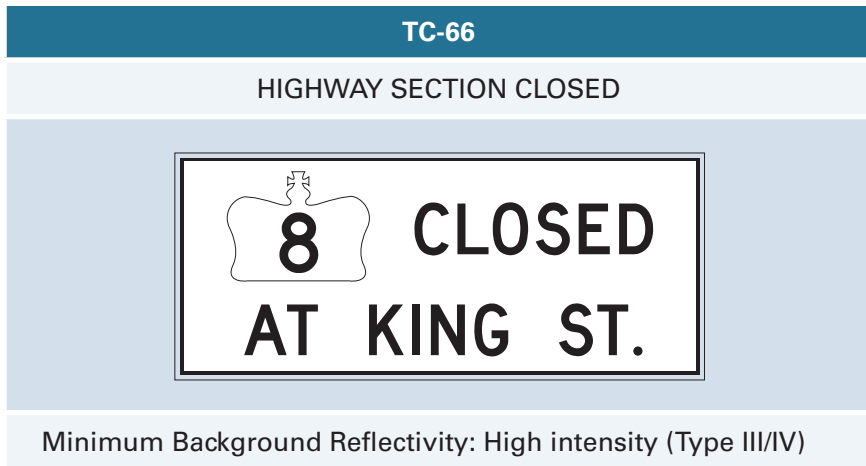

**Purpose**

The HIGHWAY SECTION CLOSED sign informs motorists of a section of through highway that is closed.

**Conditions**

- Must be installed 1 km in advance of the detour route.
- In urban areas, a reduced size sign may be used.

**Size**

- 1200 mm x 2100 mm

**Street Section Closed Sign (Advance)**

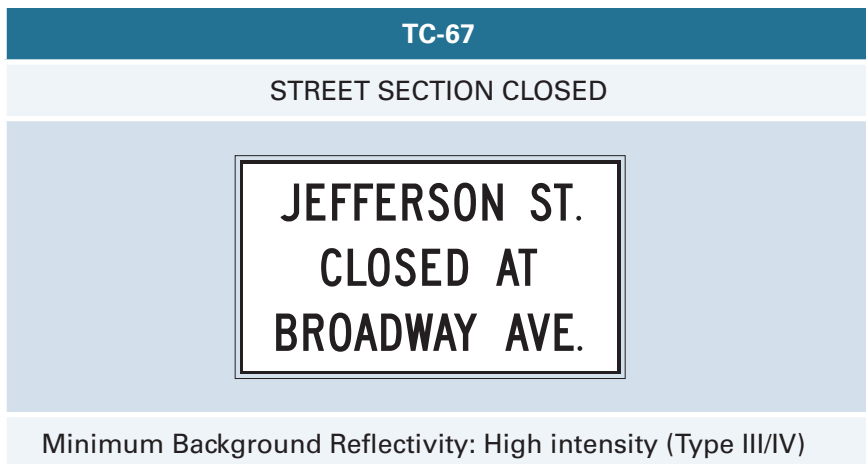

**Purpose**

The STREET SECTION CLOSED sign informs motorists that a street on which they are driving will be closed at its junction with a designated sideroad.





**Conditions**

- Must be installed 1 km in advance of the signed detour turn off.
- In urban areas, a reduced size sign may be used.

**Size**

- 1200 mm x 2400 mm

**Contract Identification Signs (Road Authority)**

CONTRACT IDENTIFICATION (MCIS MTO) Non-Funding	CONTRACT IDENTIFICATION (MCIS MTO) Funding
	
Contract Identification (Municipal)	Municipal Funding (Partnership)
	
Minimum Background Reflectivity: High intensity (Type III/IV)	

**Purpose**

The CONTRACT IDENTIFICATION sign is installed by the road authority to identify:

- A highway construction project.
- Project length.
- The road authority responsible.
- Funding Partners.

Design may vary depending on road authority.

**Conditions**

- One sign installed in each direction under construction.
- Installed in advance of the “Construction Ahead” sign closest to the construction site at the distance specified in the appropriate table ([Table A](#), [Table B](#), or [Table C](#): ‘F’).

**Size**

- **1200 mm x 2400 mm**

**Contractors Identification Sign**



**Purpose**

The CONTRACTOR'S IDENTIFICATION sign may be installed to identify the prime contractor or the contract administrator of the prime consultant for identification.

**Conditions**

- May be installed either directly beside the TC-71, TC-73, or TC-74 sign, or in the case of insufficient space, just past the CONTRACT IDENTIFICATION sign.
- When used, the sign shall only give the contractor's name.
- Sign must not resemble official highway signs.





- The background colour shall not be red, yellow, or orange.
- The sign may be non-reflectorized.

#### Size

- **900 mm x 1800 mm (maximum)**

#### Contract Information Signs

TC-81A	TC-81D
	
<p>Minimum Background Reflectivity: High intensity (Type III/IV)</p>	

#### Purpose

The CONTRACT IDENTIFICATION and CONTRACT INFORMATION signs are to be installed to inform motorists of highway improvements.

#### Conditions

- Must be installed on each approach to the contract area.
- Should not obscure any other regulatory or warning signs.

#### Sign numbers for specific projects.

- Highway improvements (TC-81A).
- Highway widening (TC-81B).
- Highway resurfacing (TC-81C).
- Bridge work (TC-81D).
- New interchange (TC-81G).

#### Size

- **900 mm x 2400 mm**

## 4.2.10 Road Closing/Restriction Notice Sign (TC-64)

The TC-64 is a static message sign and an Advance Notification Signing (ANS) device used in temporary conditions to provide highway users with advanced notice of a highway or exit ramp which is to be closed or restricted.

TC-64 shall be installed at least one week prior to the actual closing date to provide advance notice of a highway or exit ramp which is to be closed or restricted.

The following sub-sections describe the requirements and specifications for:

- Road Closing/Restriction Notice Sign.
- Physical Specifications for TC-64 Primary Signs, Auxiliary Signs, and Trailblazer Signs.
- Message Guidelines for TC-64.
- Site Selection and Installation of TC-64.

### 4.2.10.1 Road Closing/Restriction Notice Sign (Full-Time)

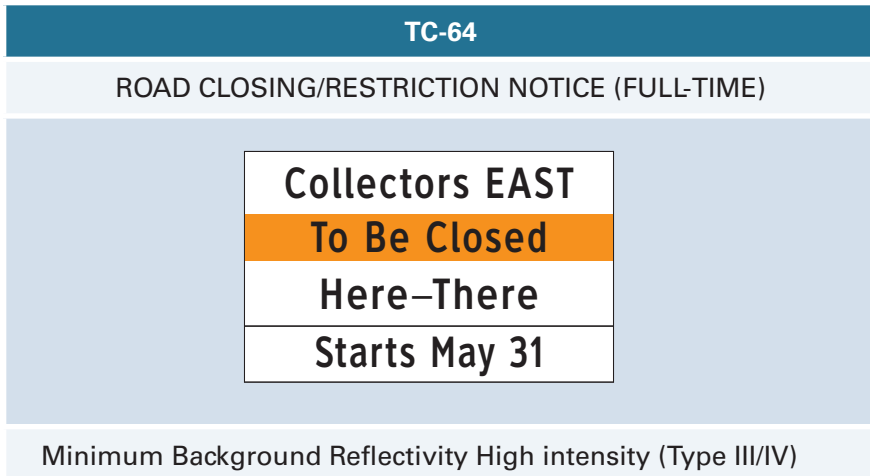

#### Purpose

The ROAD CLOSING/RESTRICTION NOTICE (FULL-TIME) sign advises the highway user of planned or ongoing work that may impact mobility.

#### Conditions

- For scheduled work the sign must be installed at least one week prior to work commencing.
- For a freeway ramp closure, the sign must be located in advance of the first guide sign that pertains to the interchange so that there is no interference with existing guide signs and removed immediately after the closing of the ramp.

- For other locations:
  - Should be located approximately 1 km in advance of the best alternative route.
  - The regulations on highway closings by the OMB must be precisely followed and where these exist, full information should be obtained from the appropriate traffic authority.

#### Size

- **1200 mm x 2400 mm (3 Lines)**
- **1500 mm x 2400 mm (4 Lines)**

### 4.2.10.2 Physical Specifications for TC-64 Primary Signs, Auxiliary Signs, and Trailblazer Signs

Physical specifications for TC-64 Primary Signs, Auxiliary Signs, and Trailblazer Signs are detailed below.

#### 1. Primary Signs

- Designed around standard (1.2 m x 2.4 m) plywood sheets.
- Resulting message area partitioned into 0.4 m x 2.4 m elements.
- A 0.4 m x 2.4 m message area is basic building block of this signing system.

#### 2. Auxiliary Signs

Auxiliary signs are 0.6 m x 1.2 m in size.

##### a) Substrate:

- A single plywood panel, minimum 12 mm thickness, meeting most recent iteration of Canadian Standards Association (CSA) Specification 0121-M 1978 (Douglas Fir) or 0153-M (Poplar).
- All surfaces to be filled, sealed and painted.
- Back of sign to be painted gray.
- No messages permitted on back of sign other than barcodes, ownership stamps or similar markings that are unobtrusive to the driver.

##### b) Sheeting Material:

- All portions of message side of sign face must be covered in sheeting.

- All sign sheeting must be retroreflective and meet latest iteration of American Society for Testing and Materials (ASTM) Specification 4956-19, for Type I material, commonly referred to as “Engineering Grade”.
- More highly retroreflective grades of sheeting materials may be specified, as conditions demand.

c) Background:

- Base message background must be white retroreflective.
- Where indicated, background colour of emphasized line of text must be orange retroreflective.

d) Lettering:

- All lettering must be black vinyl.
- Highway Gothic Font, E – Series, modified to be used for all text.
- Upper- and lower-case lettering to be used for all text, except for cardinal directions (NORTH, SOUTH, EAST & WEST).
- Lettering height must be 20 cm unless noted otherwise.
- Where proposed message exceeds horizontal dimension of sign blank, it is permissible to force letter spacing, not letter stroke or width, to 90% of its original value, in order to accommodate the message.
- Crowns containing Highway number of King’s Highway may be used on signs, provided no compromise of letter height of highway number.

e) Symbols:

- All detour symbols must be orange and be retroreflective.
- All arrows must be black vinyl (non-retroreflective).

### 3. Trailblazer Signs

Detour trailblazer signs are 0.6 m x 1.2 m in size.

a) Substrate:

- Plywood panels, minimum 12 mm thickness, meeting most recent iteration of Canadian Standards Association (CSA) specification 0121-M 1978 (Douglas Fir) or 0153-M (Poplar).
- All surfaces to be filled, sealed, and painted.
- The back of sign to be painted gray.
- Alternatively, metal sign blanks may be used.

- No messages permitted on back of sign other than barcodes, ownership stamps or similar markings that are unobtrusive to the driver.

b) Sheeting Material:

- All portions of message side of sign face must be covered in sheeting.
- All sign sheeting should be high intensity (Type III/IV) or higher.
- More highly retroreflective grades of sheeting materials may be specified, as conditions demand.

c) Lettering:

- All lettering must be black vinyl (non-retroreflective).
- Highway Gothic Font, E – Series, modified is to be used for all text.
- Letter height must be 20 cm unless noted otherwise.

For full detail of sign design and fabrication for Advance Notification, Advance Warning, and Alternate Route signs, refer to Section 3.5 of the TCTM Manual.

### 4.2.10.3 Message Guidelines for TC-64

To maintain uniformity and consistency in TC-64 information signs, general guidelines as well as specific guidelines for key traffic management strategies are presented below.

**General Guidelines:**

- Messages must not:
  - Exceed three lines of message, except during advance notification phase.
  - Exceed six (6) major elements of information on one sign (i.e., one key word, a number, or a symbol).
  - Use modifiers to highway names (i.e., Highway, Road, Street, Avenue, etc.).
- Where space for signs is limited or concerns exist regarding an overload of information presented to the driver:
  - Information on navigational restrictions must take precedence over information on capacity restrictions.
  - Temporary conditions traffic management signing takes precedence over contract identification and contractor advertising signing.
- Messages regarding limits of a closure identify first and last points of access that are closed.

- Cardinal direction information is preferred for the purpose of orientation, except where such information may prove confusing. In such instances, destination-type information (e.g., QEW Toronto) may be substituted.
- Permanent signing must be amended to agree with temporary signing.
- For full detail of message guidelines, refer to Section 3.3 of the TCTM Manual.

**Specific Guidelines:**

**1. Advance Notification Signing (ANS)**

Sign Location	Line 1	Line 2	Line 3	Line 4
<ul style="list-style-type: none"> <li>• Affected Route.</li> <li>• Crossing highways.</li> <li>• Upstream Crossing highways.</li> </ul>	<ul style="list-style-type: none"> <li>• Where the event will occur.</li> </ul>	<ul style="list-style-type: none"> <li>• What the future operational impacts on traffic will be.</li> </ul>	<ul style="list-style-type: none"> <li>• What is the extent of the activity?</li> </ul>	<ul style="list-style-type: none"> <li>• When is it scheduled to start?</li> </ul>

**Example:**

<b>Collectors EAST</b>
<b>To Be Closed</b>
<b>Here–There</b>
<b>Starts May 31</b>

**2. Advance Warning Signing (AWS)**

Sign Location	Line 1	Line 2	Line 3
<ul style="list-style-type: none"> <li>• Affected Route.</li> <li>• Crossing highways.</li> <li>• Upstream crossing highways.</li> </ul>	<ul style="list-style-type: none"> <li>• Where the event will occur.</li> </ul>	<ul style="list-style-type: none"> <li>• What are the current operational impacts on traffic?</li> </ul>	<ul style="list-style-type: none"> <li>• What is the extent of the activity?</li> </ul>

Example:

<b>Collectors EAST</b>
<b>Closed</b>
<b>Here–There</b>

### 3. Alternative Route Signing (ARS)

Two levels of alternative route information can be provided.

Sign Location	Line 1	Line 2	Line 3
<ul style="list-style-type: none"> <li>Affected Route.</li> <li>Crossing highways.</li> </ul>	<ul style="list-style-type: none"> <li>What routes are affected?</li> </ul>	<ul style="list-style-type: none"> <li>“Via”, indicating what follows is the alternative route to reach the affected links.</li> </ul>	<ul style="list-style-type: none"> <li>The alternative route.</li> </ul>

Example:

<b>Collectors EAST</b>
<b>Closed Tonight 10 PM</b>
<b>Yonge–Bayview</b>

Followed by a second sign:

<b>Yonge–Bayview</b>
<b>Via</b>
<b>Avenue Road</b>

### 3a). Intercept Alternative Route Signing (IARS) and Intercept Detour Route Signing (IDRS)

Both IARS and IDRS are two-sign systems.

Sign Location	Line 1	Line 2	Line 3
<ul style="list-style-type: none"> <li>Parallel highway.</li> <li>Upstream crossing highway.</li> </ul>	<ul style="list-style-type: none"> <li>What routes are affected?</li> </ul>	<ul style="list-style-type: none"> <li>“Via”, indicating what follows is the alternative route to reach the affected links.</li> </ul>	<ul style="list-style-type: none"> <li>The alternative route.</li> </ul>

Example:

<b>401 Collectors EAST</b>
<b>Closed Tonight 10 PM</b>
<b>Yonge–Bayview</b>

Followed by a second sign:

<b>401 Collectors EAST</b>
<b>Via</b>
<b>York Mills/Leslie</b>

### 3b). Detour Route Signing (DRS)

DRS is a further enhancement to the basic ARS concept. DRS requires the installation of a second sign on the affected route, and trailblazing on the alternative route.

Sign Location	Line 1	Line 2	Line 3
<ul style="list-style-type: none"> <li>Affected Route.</li> <li>Crossing highway.</li> </ul>	<ul style="list-style-type: none"> <li>What routes are affected?</li> </ul>	<ul style="list-style-type: none"> <li>“Via”, indicating what follows is the alternative route to reach the affected links.</li> </ul>	<ul style="list-style-type: none"> <li>Which trailblazer route to follow (i.e., D-1)?</li> </ul>

Example:

<b>401 Collectors EAST</b>
<b>Closed Tonight 10 PM</b>
<b>Yonge–Bayview</b>

Followed by a second sign:

<b>401 Collectors EAST</b>
<b>Via</b>
<b>Avenue Road</b>

On the second sign, a detour trapezoid symbol would be included in the last line of the message. Detour Trailblazer Signing, described below, would then be placed at each subsequent decision points along the route.



### 3c). Detour Trailblazer Signing (DTS)

DTS takes the detour trapezoid and detour number and pairs it up with either a directional arrow (left, right, or straight ahead) or with the word “Ends” to communicate directions to drivers at decision points along the route. This provides a route guidance tool to trailblaze the alternative route.

#### 4.2.10.4 Site Selection and Installation of TC-64

The location of TC-64 must ensure adequate visibility, roadside safety, and consideration to the availability of power and communication to install PVMS.

##### Visibility

- Horizontal and vertical geometries of a highway will have the greatest effect on the visibility of a sign. Whenever possible, the sign should be placed on a tangent section of the highway, while maintaining the intent of the message content.
- On freeways, message signs should be located 1000 metres to 1500 metres upstream of interchange decision points.
- On arterial highways, message signs should be located 600 metres to 1000 metres upstream of decision points.
- If multiple TC-64 are located close together, but show only one language, a minimum longitudinal distance of 150 metres should separate the signs to allow drivers to read and process the first sign before they see the second one.
- TC-64 should not obstruct and should not be obstructed by, any existing signs or other objects.
- TC-64 need to be sufficiently away from nearby ground-mounted static signs so that motorists can focus their attention on the message without being distracted by other signs.
- When placing a sign within the limits of a construction zone, ensure that it does not interfere with construction operations.

#### 4.2.11 Dynamic Message Signs and Devices

Advances in technology have and will continue to increase the use of dynamic signs and devices to provide guidance and information to highway users or enhance static signs in temporary conditions.

The following sub-sections describe the requirements and specifications for:

- Portable Variable Message Signs (PVMS).
- Physical Specifications for PVMS.
- Message Guidelines for PVMS.
- Site Selection and Installation of PVMS.
- Flashing Arrow Board Signs (TC-12).
- Speed Display Signs.
- Supplementary Flashing Lights.

#### 4.2.11.1 Portable Variable Message Sign (PVMS)



##### Purpose

The PORTABLE VARIABLE MESSAGE SIGN (PVMS) should be used in situations where conditions are changing. PVMS are always applied in addition to the required signage as described in Book 7 and should never replace any of the required signs. PVMS should not be used if standard traffic control devices adequately provide information that a highway user needs to travel safely.

PVMS are dynamic traffic control devices capable of digitally displaying a variety of messages via elements on the face of the sign that can be activated to form letters or symbols. Messages are limited by the size of the sign (usually three lines with eight characters per line). They provide guidance and information to road users and can enhance static signs in temporary conditions.

Multifunctional PVMS can fulfill a variety of functions, such as:

- Pre-programmed messages.
- Radar speed measurement and display.

These functions should only be used for those applications where they fully meet the requirements provided in OTM Book 7.

General aspects of PVMS follow:

- A PVMS is housed on a trailer or truck bed and can be quickly deployed to meet the temporary requirements frequently found in work zones or incident areas.
- The most common use of PVMS in work zones is for LD construction work. They are typically used to provide highway users with advance notification of work operations which are outside their expectations, such as closures or speed reductions.
- In order to achieve a high level of respect for PVMS, message displays must provide highway users with a concise and accurate message relevant to the situation they will be encountering, thus enhancing system credibility and therefore effectiveness.
- PVMS should only be used in situations where conditions are changing. PVMS are always applied in addition to the required signage as described in Book 7 and should never replace any of the required signs. If standard traffic control devices adequately provide information that a road user needs to travel safely, PVMS should not be used.

**NOTE**

PVMS are applied in addition to the required signage as described in this.

On provincial highways a PVMS may be used during the following conditions (with duration not exceeding 9 days):

- Advanced notification of continually changing highway situation (hour by hour).
- Advance notification of closures due to construction or maintenance.
- Advance notification of major special events impacting traffic
- Notification of short-term lane closures and detours during construction, maintenance, and special events.
- Notification of long-term changes in road configuration.
- Temporary notification of long-term conditions until static signs can be manufactured.

**NOTE**

The determination of whether and where PVMS are to be used is at the discretion of the road authority.

The determination of whether and where PVMS are to be used in a work zone is at the discretion of the road authority. Technical descriptions and specifications for PVMS signs are provided in OTM Book 10 (Dynamic Message Signs) and PVMS Best Practices Manual (developed by MTO, May 2009).

#### 4.2.11.2 Physical Specifications for PVMS

A brief description of the physical aspects that must be considered when PVMS are to be used on provincial highways is provided below.

## Display Elements

Display elements must conform to specifications, as they will influence the overall legibility of the sign. Physical aspects include the following:

- Signs shall have a 30-pixel high by 56-pixel wide full matrix amber display.
- The colour of all pixels should be uniform across the display.
- Each PVMS pixel should be capable of achieving a luminance of 40 candelas at the brightest level.
- The PVMS should incorporate a photocell control system to automatically adjust the brightness as a function of the ambient light level (brighter during the day, dimmer at night).
- The luminance of a PVMS pixel should not decrease by more than 50% when viewed at a minimum angle of 15 degrees centered about the optical axis and perpendicular to the surface of the display (half angle of 7.5 degrees).
- The sheeting which covers the display elements also influences the legibility of the sign. The sheeting material should minimize glare and reflection in all lighting conditions.
- Contrast ratios, technology details, line and character spacing, and fonts should be designed as outlined in OTM Book 10 (Dynamic Message Signs).

## Sign Case

The sign case is the structure that protects the display elements and associated electronics from the elements.

The MTO PVMS specifications for sign cases found in OTM Book 10 provide further information on the following:

- Physical requirements of the sign case.
- Specifications for the retroreflective border to go around the front outside edge of the sign case to improve the target value of the sign.

## Solar Panels

Solar panels should be supplied with each sign by default. They should be able to tilt and rotate so they can be aimed towards the sun.

If signs are deployed in areas where they can be hardwired with power, the solar panels can be removed to prevent theft and vandalism.

## Electrical System

The electrical system provided with a PVMS shall be able to operate with batteries recharged by solar panels or a trickle charger, or by using a hardwired power supply.

## Global Positioning System (GPS)

A GPS unit integrated with the PVMS controller allows for continuous updating of the PVMS location at any given time.

Since PVMS can be used anywhere in any given region, it is important to be able to track them.

Misplacement of a single sign due to misunderstanding of its true location can cause:

- Operational issues.
- Display of incorrect information.

The worst effect of this confusion would be to have messages sent to the wrong signs due to misunderstanding of their true location. A GPS unit that is integrated with the sign controller allows for continuous updating of the PVMS location.

## Sign Face Compass

A sign face compass provides the ability to monitor and record the direction of the PVMS, and is an integral part of the PVMS for the following reasons:

- Although there is a braking mechanism to prevent the sign face from rotating on its own, due to the large surface area, high winds may cause the sign face to rotate and in extreme cases, could cause the entire PVMS to shift.
- Where poor legibility of a PVMS is reported, the operator can check, through the software, on the current direction of the sign face thereby confirming whether poor legibility is due to a rotated sign face.
- The compass supports in determining sign location. Since the GPS will generally not provide an accurate enough location to determine which side of the highway a sign is on for two-lane highways, the compass will show the direction of travel that the sign is facing to allow confirmation of the side of the highway that it is on.
- Compass functionality may be included as part of the GPS by some manufacturers.

## Communication Protocol and Control

To ensure all PVMS signs available to a given control centre can communicate from the same central software, it is necessary to use a standard communications protocol.

- The National Transportation Communications for ITS Protocol (NTCIP), developed in the USA through several standards agencies (AASHTO, NEMA, etc.), provides an appropriate level of standardization for communication protocols for PVMS and is required for all new PVMS in the Province of Ontario.
- The Regional COMPASS Traffic Operations Centre or Communications Centre controls all PVMS messages on provincial highways, whether a contractor or MTO-owned sign, or a third-party rental sign.
- Control can range from full messaging responsibility to only the ability to blank or override a sign message when necessary. To enable this communication, it is imperative that supplied signs comply to MTO communication standards.

### 4.2.11.3 Message Guidelines for PVMS

PVMS must provide road users with a concise message relevant to the situation they will be encountering. PVMS used on construction projects and maintenance activities should be treated as an integral part of the Traffic Control Plan and the following information should be listed for all known or anticipated PVMS during a project:

- Desired messages.
- Locations.
- General time periods of display.
- The ITS Program sections and regional Traffic must approve all PVMS messages used on signs located on provincial highways. Pre-approved messages should be stored either:
  - a) Locally in the PVMS; or,
  - b) Centrally in the server that runs the PVMS application as per Regional requirements.

**NOTE**  
The ITS Program sections and regional Traffic must approve all PVMS messages used on signs located on provincial highways.

This prevents spelling errors, missed words, or incoherent/ineffective messages being displayed.

When not in use, the PVMS should be turned parallel to the flow of traffic so that motorists do not see its screen (if possible).

**NOTE**  
When not in use, the PVMS should be turned parallel to the flow of traffic so that motorists do not see its screen.

#### Message Format

The format of the PVMS message is important. Road users must receive information in a manner consistent across the province to help them understand the message easily and have enough time to react accordingly.

The format must be developed so that drivers can quickly determine if a message does not apply to them. For example, placing the name of the connecting highway first in the message immediately targets only drivers who are interested in using the identified road.

### Units of Information/Major Words

A unit of information answers a specific question, such as, ‘What happened?’, ‘Where did it happen?’, and ‘What are its effects?’ For example, each of the following is a unit of information.

What Highway?	417 WEST
Where?	AT MAITLAND
What is happening?	LANE REDUCTION
When?	At 10 PM

A typical weather warning message is shown below:

DRIFTING SNOW POSSIBLE	DRIVE WITH CAUTION
---------------------------	--------------------

- The first phase, or message segment, contains three major words: “DRIFTING”, “SNOW” and “POSSIBLE”.
- The second phase has two major words: “DRIVE” and “CAUTION”.
- The word “WITH” is not considered a major word. “DRIVE WITH CAUTION” could also be considered as a unit of information because it expresses a single thought.

### Multi-Phase Messages

As mentioned above, a phase refers to a message segment which is individually displayed. For example,

FIRST PHASE	SECOND PHASE
“Maitland Exit”	“Closed Until 9 am”

Human factor studies have shown that for most drivers:

- There is not enough reading time for more than two phases of information.
- They are unable to retain more than two phases of information.

Therefore, a maximum of two phases per sign is permitted under normal circumstances.

#### NOTE

A maximum of two phases per sign is permitted under normal circumstances.

When designing a two-phase message:

- The wording must make sense regardless of which phase the driver reads first.
- Each phase should contain a complete thought.
- Multi-word units of information shall not be broken across phases.

The following are message guidelines for the number of phases that are required to convey a message:

#### One-Phase PVMS:

- Line 1—Describe effect to the road or access.
- Line 2—Identify location or distance ahead.
- Line 3—Provide motorist instruction.

#### Two-Phase PVMS:

- Phase 1—Describe effect to the road or access.
- Phase 2—Provide motorist instruction.

### Use of Alternate Display Techniques

Several alternate display techniques, usually associated with advertising signs, are technically possible in the control of PVMS for highway use; however, are not allowed for MTO PVMS installations. These include:

- Message flashing, where the message cycles on and off several times a minute to draw the observer's attention to the message. This can occur with all or part of the message. Flashing messages take longer to read than static messages and are not to be used.
- Message alternating, where two physically separate signs, which are close enough to be perceived by drivers as a pair, are used to convey parts of a message. Apart from bilingual applications, this approach is inconsistent with other types of signing on the highway. Message alternating has been shown to be confusing to drivers and shall be avoided.
- Message scrolling, where the message appears to scroll from right to left across the screen or top to bottom to accommodate longer messages than otherwise possible. This technique requires significantly more attention from drivers as they cannot just glance at the message but must watch it scroll. This constitutes a potentially hazardous distraction and shall not be implemented.

#### NOTE

Flashing messages take longer to read than static messages and are not to be used.

#### NOTE

Message alternating has shown to be confusing to drivers and shall be avoided.



## Signing in Designated Bilingual Areas

All French translations must be approved by the road authority.

Given the current industry standard, many PVMS can display three lines of text. As a result, two approaches for PVMS messages are permissible for use in Ontario's designated bilingual areas.

1. From a human factor's perspective, the preferred approach is to use two PVMS – one for each language.
2. The other permissible approach, though less effective, is to use a single PVMS to display the two-phase messages, where each phase is used for one language.

### NOTE

All French translations must be approved by the road authority.

To determine which approach to use, it is necessary to review all the messages intended for the location. If they can all be fit on one phase for English and one phase for French, then a single sign will suffice. Otherwise, two signs are required.

In the case of two signs, each with a different language, drivers do not need to read both signs and the spacing between should be 75 metres. However, care must be taken at setup, so the first sign does not block the view of the second sign. If this is the case, the distance between the signs may need to be increased.

The sign that displays the English message should always be set up first to provide consistency across the province.

### Evaluation Guide for PVMS

Acceptable	Unacceptable
90% or more of the pixels per character module are properly operating.	Fewer than 90% of the pixels per character module are properly operating. Not performing within the criteria in OTM Book 10 (Dynamic Message Signs). Message clarity is significantly impacted.

#### 4.2.11.4 Site Selection and Installation of PVMS

The location of PVMS must ensure adequate visibility, roadside safety, and consideration to the availability of power and communication to install PVMS.

#### Visibility

- Horizontal and vertical geometries of a highway will have the greatest effect on the visibility of a sign. Whenever possible, the sign should be placed on a tangent section of the highway, while maintaining the intent of the message content.

- On freeways, message signs should be located 1000 metres to 1500 metres upstream of interchange decision points.
- On arterial roads, message signs should be located 600 metres to 1000 metres upstream of decision points.
- If multiple PVMS are located close together, but show only one language, a minimum longitudinal distance of 150 metres should separate the signs to allow drivers to read and process the first sign before they see the second one.
- PVMS should not obstruct and should not be obstructed by, any existing signs or other objects.
- PVMS need to be sufficiently away from nearby ground-mounted static signs so that motorists can focus their attention on the message without being distracted by other signs.
- When placing a sign within the limits of a construction zone, ensure that it does not interfere with construction operations.

**NOTE**

PVMS should not obstruct and should not be obstructed by, any existing signs or other objects.

**Roadside Safety**

- A PVMS can become a roadside hazard to the travelling public. Therefore, PVMS should be placed outside the clear zone for a given section of highway or placed behind a section of guide rail.
- The PVMS should be far enough behind a guide rail to account for the deflection angle of the given guide rail style.
- When locating the PVMS, it is important to remember that the sign head is significantly wider than the trailer when in the display position. On municipal highways if the PVMS cannot be protected by a guardrail or barrier, then it is recommended that orange cones or drums be used.

**Installation**

- The signs shall be installed level.
- The bottom of the sign display shall be at least 1.5 metres above the adjacent edge of the pavement elevation.
- PVMS shall be set at the proper angle to traffic to maximize the time that drivers are viewing the sign in the centre of the viewing angle. With such a narrow angle of good luminance, sign positioning (angle) in work zones becomes critical.
- A sight tube for aiming the device is required on new PVMS. The sign should be aimed such that the message is legible from at least 300 metres for freeway applications and at least 200 metres for arterial road applications.

### 4.2.11.5 Flashing Arrow Board (TC-12)

- FLASHING ARROW BOARDS are used to increase conspicuity, to indicate lane closures in stationary or mobile work operations and guide traffic along the desired path.

#### Flashing Arrow Boards

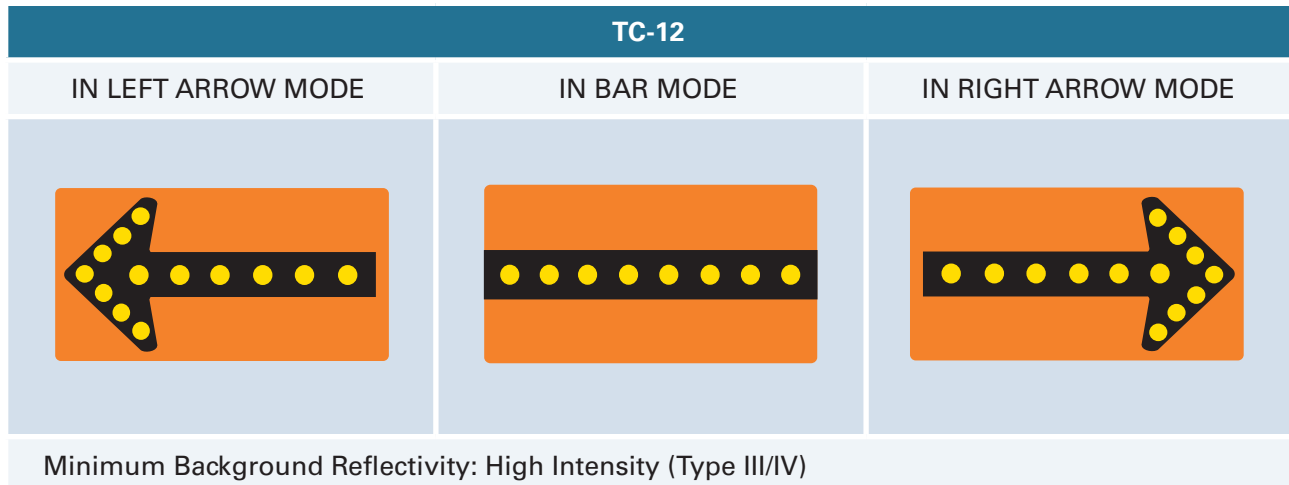

#### Purpose

The FLASHING ARROW BOARD is used to alert motorists of lane or shoulder closures.

#### Operation

FLASHING ARROW BOARDS are used on urban and rural freeways, or other multi-lane major highways, to warn and guide traffic through a work area, while also enhancing safety to the work crew in conditions such as:

- Day or night closures.
- Mobile operations for maintenance or construction.
- High-risk operations requiring more elaborate means to warn and guide traffic through a work area.

TC-12 are mounted on motor vehicles or trailers. The signs can be illuminated in four different modes:

1. Single arrow mode (right) - Stationary Operations - indicates that a lane change to the right is required. Mobile Operations - also indicates that drivers are to keep right.
2. Single arrow mode (left) - Stationary Operations - indicates that a lane change to the left is required. Mobile Operations - also indicates that drivers are to keep left.
3. Both arrows mode - should only be used under low speed (60 km/h or less) traffic conditions. Both arrow mode indicates that a lane change to the left or the right is required.

4. Bar mode - Is used downstream of a TC-12 in arrow mode in a closed lane or shoulder to identify the work area or work vehicle.

### Conditions:

#### General

ATC-12 must not be used in arrow mode with:

- A Traffic Control Person (TCP), if the proximity of the TC-12 may reduce the visibility of the TCP. In this situation, the TC-12 must also not be used in bar mode.
- An AFAD (Automated Flagger Assistance Device).
- A Traffic control signal (portable or temporary).
- The YIELD TO ONCOMING TRAFFIC (Rb-91) sign.

The TC-12 sign must be mounted at a minimum of 1.5 m above the highway to qualify as a replacement device for other traffic control devices.

#### Multi-lane Highways

Stationary Operations:

- Within the coned area, one TC-12 in arrow mode must be used at the end of each taper to indicate that one lane change is required.
- Any additional TC-12, in the same lane downstream, must be in bar mode to indicate that the vehicle/trailer on which the TC-12 is mounted is in a closed lane (or on the shoulder), and that no further lane changes are required.
- One TC-12 in arrow mode may also be used as an advance warning sign on the shoulder.

Mobile Operations:

- A TC-12 in arrow mode is used on sign trucks and Buffer Vehicles to indicate the direction in which the traffic is permitted to pass and to reinforce the need to keep to the side of the vehicle.
- When a sign truck/Buffer Vehicle is following a work vehicle, at a distance of Lateral Intrusion Deterrence Gap (LIDG), the TC-12 on the work vehicle shall be in bar mode indicating a lane closure as illustrated in layouts [US-14](#), [DS-14](#), [US-12](#), [DS-12](#), [FS-5](#), and [FS-6](#).
- When there is no sign truck/Buffer Vehicle following the work vehicle, the TC-12 on the work vehicle shall be in arrow mode as illustrated in [US-13](#) and [DS-13](#). The TC-12 on all sign truck/Buffer Vehicle(s) upstream of the work vehicle shall be in arrow mode for multi-lane highways mobile operations.

- TC-12 should be used in bar mode for shoulder work, except during setup/removal of traffic control devices.

In mobile operations, TC-12 signs are used in the arrow mode on sign trucks and Buffer Vehicles on multi-lane highways to reinforce the need to keep to the side of the vehicle.

### Two Lane Highways

#### Stationary Operations:

- The TC-12 must be used in bar mode only. The TC-12 must not be used in arrow mode.
- TC-12 should be used in bar mode for shoulder work, except during setup/removal of traffic control devices.

#### NOTE

The TC-12 sign must not be used in arrow mode on two-lane highways.

#### Mobile operations:

- The TC-12 must be used in bar mode.

### Visibility Distance

Required visibility distances (day or night) for the TC-12 is as follows:

- For NPRS of 90 km/h or greater, the distance must be 900 m with the flashing lights on, and 350 m for the recognizable arrow or bar shape.
- For NPRS of 70 km/h to 80 km/h, the distance must be 600 m with the flashing lights on, and 250 m for the recognizable arrow or bar shape.
- For NPRS of 60 km/h and lower, the distance must be 450 m with the flashing lights on, and 175 m for the recognizable arrow or bar shape.

### Sign Panel

Sign Panel requirements for the TC-12 is as follows:

- The black arrow silhouette design and orange reflective background (to act as a fail-safe device) must be used on all TC-12.
- The panel shall be one-piece design, equipped with remote-controlled mode activation mechanisms mounted on the panel.
- The actuation time of the mode activation mechanisms from the closed position to the open position or vice versa shall be 10 seconds maximum.
- The arrows and arrow shaft (bar) shall be black in colour.
- The background must be Type III/IV, high intensity, retroreflective orange sheeting, to provide for fail-safe operations in case of power failure.

## Sign Panel Lighting

Sign panel lighting requirements for the TC-12 sign is as follows:

- The sign panel should incorporate four illumination modes: right arrow, left arrow, both arrows, and bar mode. Only one mode shall be visible at a time to the approaching traffic, and only the lights within the operating mode shall be visible.
- The amber lights on all TC-12 must flash simultaneously or sequentially to increase the conspicuity and attention-getting value of the arrow. For night use, the light intensity must be reduced.
- For use on freeways, the TC-12 must have 15 to 19 amber halogen lamps, or LED lamps, arranged in the form of an arrow that meet the required visibility distances as prescribed above or equivalent as approved by the road authority.
- The smaller TC-12 (non-freeway, striper, emergency) must have sufficient lights to provide distinct arrow and bar shapes with a minimum of 12 lamps for non-freeways and 14 lamps for stripers.
- The arrow head and shaft shall flash simultaneously (arrow on/off). Alternatively, the arrow shaft and head may flash sequentially, with the arrow shaft coming on first and then the arrow head, the shaft remaining on so that at the end of the cycle, the complete arrow appears (shaft and head).
- A photo-electric cell with 110 lux (10-foot candelas) sensitivity for the night dimmer shall be supplied to automatically reduce lamp intensity.
- The lights shall flash approximately 40 to 50 times per minute. The “ON” phase must be on for 50% of the cycle time.

## Electronic Controller

Electronic controller requirements for the TC-12 is as follows:

- The controller shall operate the following functions (from inside the cab, if truck-mounted). Note: some of these functions may be automatically adjusted:
  - Left flashing arrow.
  - Right flashing arrow.
  - Bar mode.
  - Both arrow mode, if present.
  - Specified flashes per minute.
  - Light intensity.
  - Remote-controlled mode activation mechanisms.

### Crashworthiness

Trailer-mounted TC-12 located on the highway must be crashworthy.

- The design should be lightweight with the centre of gravity of the unit near or below that of impacting vehicles.
- If impacted, detached elements, fragments, or other debris from the device should not penetrate or show potential for penetrating the passenger compartments of vehicles or present undue hazard to the public or workers.

### Size

Non-Freeways:

- **600 mm x 750 mm**
  - Bar/arrow shaft size 150 mm x 750 mm, minimum 12 amber halogen or LED lamps.

Freeways:

- **1200 mm x 2100 mm**
  - Bar/arrow shaft size 300 mm x 2100 mm, 15 to 19 amber halogen or LED lamps.
- **600 mm x 150 mm** - striper truck mounted.
  - Bar/arrow shaft size 150 mm x 1500 mm, minimum 14 amber halogen or LED lamps.
  - May be used for freeway paving operations, freeway patrol, or freeway emergency response only.

## 4.2.11.6 Dynamic Speed Display Sign

### Purpose

Dynamic Speed Display Signs (DSD) are implemented where there is a desire to reduce the operating speed.

### Operation

DSD Sign, where the vehicle speed is measured by radar and displayed to the driver on a dynamic message board, has shown in some applications to reduce 85th percentile speeds by an additional 4 to 8 km/h over the reduction caused by static signs alone. DSD may also display the posted regulatory speed sign or the advisory speed sign.

When drivers see their speed displayed, they:

- May be genuinely surprised that they are exceeding the speed limit and may reduce their speed.
- May be uncertain as to whether a sign that shows their speed means that enforcement is nearby and may reduce speed to avoid a potential fine.
- May increase speed.

The use of DSD signs are most effective when:

- Multiple DSD signs are staggered through long work zones.
- Supported by ongoing police enforcement, especially for long duration use.
- Signs are strategically placed in relation to the location where the speed change is desired and relative to other traffic control devices.

Road authority approval and enforcement consultation should be obtained prior to the use of speed display signs.

### Condition

Dynamic speed display may be used when:

- The work duration is Short Duration or Long Duration.
- Traffic Control Persons are present;
- Work zone speeds cause significant hazard; or
- Drivers have the tendency to disregard the speed limit at the location.

#### NOTE

Dynamic Speed Display signs should not be used for one lane of a multi-lane highway.

Dynamic speed display should not be used:

- On high speed - high volume roads as the display changes too rapidly for motorists to make a connection to the themselves.
- If they will distract motorist attention from more important warning and guidance signage through a temporary condition.
- For one lane of a multi-lane highway.
- For prolonged periods without regular enforcement.

#### NOTE

Dynamic Speed Display signs should not be used for prolonged periods without regular enforcement.

Dynamic speed display must not be used:

- On multiple lanes open in the same direction of travel as it will be unclear which vehicles speed will be displayed.
- When there is no significant concern due to vehicle speed.



Location of DSD should:

- Be 100 m following a posted regulatory/advisory speed change or 100 m following the end of taper for a lane closure.

DSD must:

- Be placed outside the clear zone for a given section of highway or placed behind barrier.
- Be far enough behind barrier to account for the deflection angle of the given barrier style.
- Follow manufacturer specifications.

Refer to OTM Book 10 (Dynamic Message Signs) for guidelines on placement of DSD.

### 4.2.11.7 Supplementary Flashing Lights

#### Purpose

Supplementary Flashing Lights are used to attract the attention of drivers to the sign message or identify a hazard or obstruction. Construction, maintenance, and other activities within a highway often create conditions that are particularly hazardous at night when the vision of highway users is reduced. There are both daytime and night-time situations where it is necessary to increase the target value and impact of warning signs by installing amber flashing devices over these signs.

#### NOTE

Flashing lights must not be used in conjunction with PVMS.

#### Condition

- Flashing devices alone, with the exception of TC-12, must not be used for channelization purposes as they may obscure the intended vehicle path.
- All flashing lights must operate on a lower setting of light intensity during hours of darkness.
- Flashing lights must not be used in conjunction with PVMS.

### 4.2.11.8 Queue-End Warning

Queue-end warning is used to allow drivers to slow down in advance of reaching the queue and to avoid rear-end collisions at the upstream of the work area. If a pre-determined queue length is known, a static sign, such as TC-20, is used to inform drivers of the queue ahead. Alternatively, if the queue length is being monitored dynamically, a system of traffic sensors may be integrated to a dynamic message sign, such as PVMS. The sensor to detect a queue-end should be listed as MTO's Designated Sources of Materials (DSM) for MTO projects or be pre-approved by the road authority. If a desired sensor is not listed as MTO's DSM or is not pre-approved by the road authority, MTO or the road authority should provide minimum requirement specifications.

Queue-end warning may be used when:

- The work duration is Short Duration or Long Duration;
- Highway geometries approaching the work zone have horizontal or vertical curves that restrict queue visibility; or
- Unexpected queues build upstream of the approach area.

Queue-end warning should not be used:

- When there is no anticipated buildup of queues.

[Figure 4.5](#) illustrates an example setup of the static queue-end warning. Static signs are placed at appropriate locations based on the anticipated queue length.

[Figure 4.6](#) illustrates an example setup of the dynamic queue-end warning system. A set of 4 approved queue detecting sensors from MTO's DSM and a PVMS are installed at pre-defined locations. Additional PVMS may be placed as required with additional sensors installed. Road authority approval and consultation must be obtained prior to the use of the dynamic queue-end warning system.

Both, [Figure 4.5](#) and [Figure 4.6](#), are supplementary figures to show how queue-end warnings would look. In practice, queue-end warnings must be integrated with other appropriate traffic control layouts.

Figure 4.5 Static Queue-End Warning

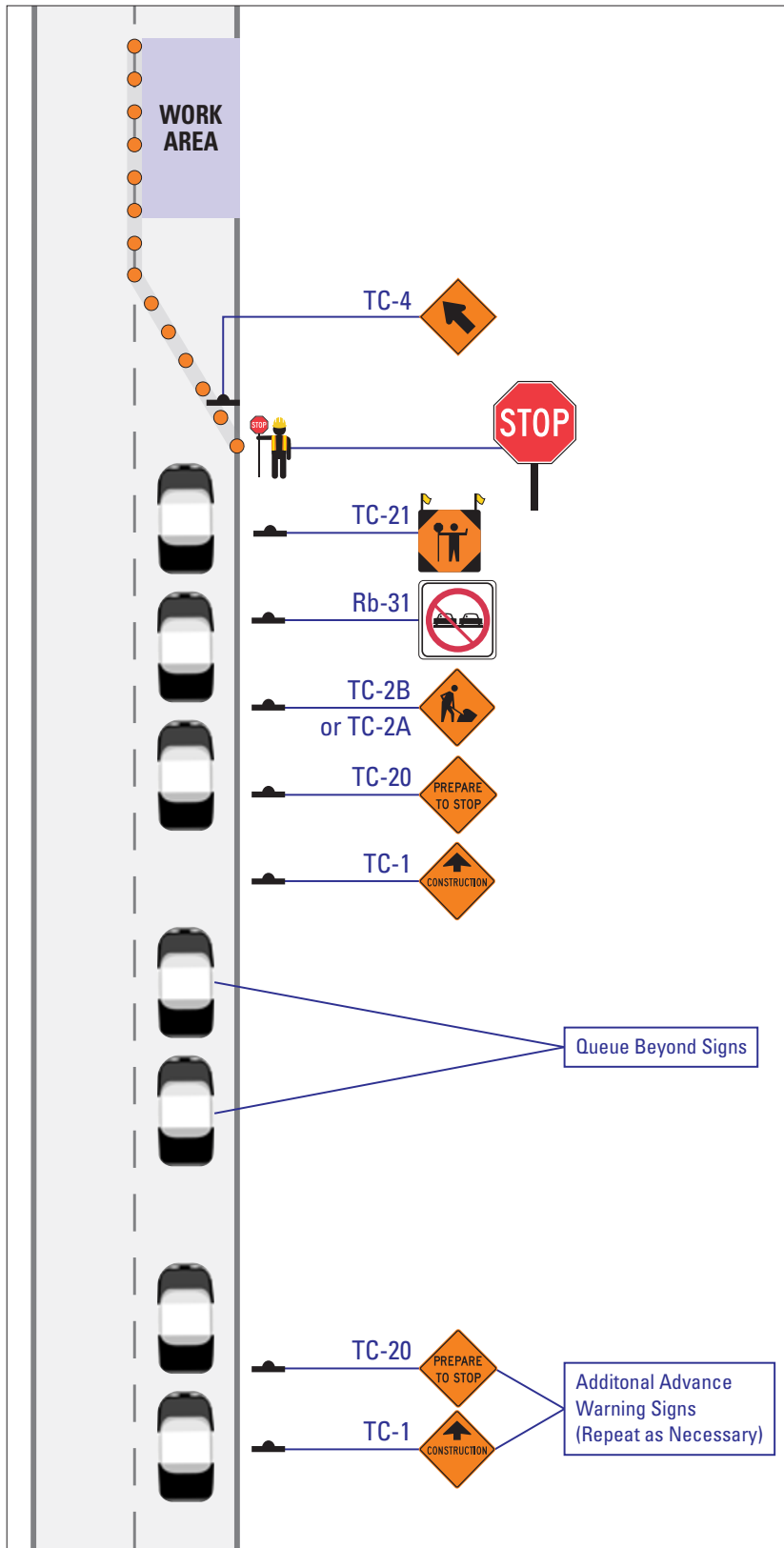
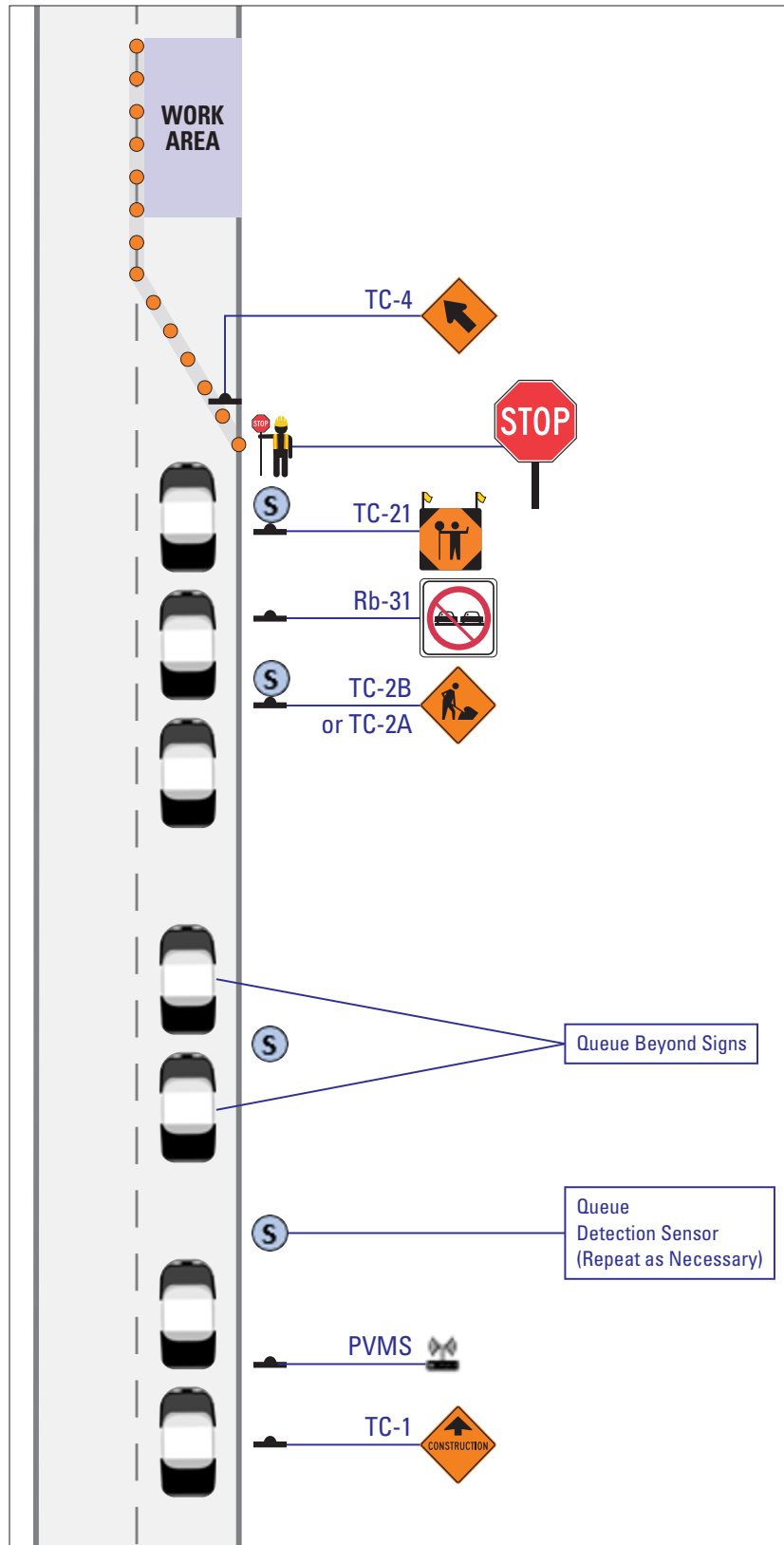

Figure 4.6 Dynamic Queue-End Warning



## 4.3 Advance Notification, Advance Warning, and Alternate Route Signs

---

Section 4.3.1 provides information on the three key traffic management strategies, that address driver expectations and traffic demand during temporary conditions. Section 4.3.2 provides information on using queue-end warning to alert drivers of potential queues ahead of time.

Physical specifications and message guidelines are provided for the Road Closing/Restriction TC-64 sign ([Section 4.2.10](#)) and Portable Variable Message Sign ([Section 4.2.11](#)) devices, which are used to provide advance notification, advance warning, and alternate route, as well as information on site selection and installation of these message signs.

### 4.3.1 Temporary Conditions Traffic Management (TCTM) Manual

---

The MTO's TCTM Manual promotes uniformity of treatment in the design, selection, application, and operation of temporary conditions traffic management systems on provincial highways. The Manual encourages consistency in safe and efficient TCTM practices by providing principles, policies, standards, guidance, and working examples; and is primarily intended for those with responsibility for the planning, design, installation, management, supervision, or enforcement of work zone traffic management and control measures.

The TCTM Manual defines three key traffic management strategies to address the management of driver expectations and traffic demand during temporary conditions:

1. Advanced notification.
2. Advanced warning.
3. Alternative routing.

These strategies, as they pertain to signing during temporary conditions, are defined below. The three key signing strategies function most effectively under certain circumstances. Criteria for their use is outlined below.

For more information on these strategies and their applications, refer to the TCTM Manual.

#### 4.3.1.1 Advance Notification Signing (ANS)

Signing installed on an affected route prior to the establishment of a work zone. Used to forewarn regular users of a route that work is planned in the near future.

### Characteristics

- Temporary or time-oriented signs that raise awareness regarding a **future, planned work activity** before it is scheduled to occur.
- Effectively communicates the time, duration, extent, and potential impact of the planned work activity.
- Located on the affected facility, upstream of the work zone.
- Primarily aimed at recurring highway users (i.e., daily commuters or weekend recreational travellers), allowing them to alter route plans.
- Typically a TC-64 ROAD CLOSING/RESTRICTION, TC-65 ROAD CLOSING or PVMS.

### Criteria for Use

ANS should be used when critical capacity will be reduced, or navigational freedom will be restricted on:

- Commuter and commercial routes due to:
  - Continuous activity exceeding 48 hours duration.
  - Part-time, recurring activity during the same period (i.e., nightly lane closures) twice or more over a span of 7 consecutive days.
- Recreational routes due to:
  - Activity at any time during peak travel periods of a holiday weekend.
  - Continuous activity exceeding 7 days duration.
  - Part-time, recurring activity (i.e., nightly weekend closures) on two or more consecutive weekends.

#### 4.3.1.2 Advance Warning Signing (AWS)

Signing installed on an affected route to inform road users of the scope, extent, and duration of a planned work activity. Work may be continuous or reoccurring.

### Characteristics

- Situational or location-oriented signs that raise awareness regarding the location, extent, duration, and degree of encroachment of an **ongoing activity**.
- Provide near “real-time” information regarding recurring activities such as lane closures.
- Located on the affected facility, an adequate distance upstream of the work zone.
- Raise driver awareness well in advance of the tail of the queue when work is in progress.
- Allow drivers to exit the facility and seek an alternative route.

- Typically TC-66 HIGHWAY SECTION CLOSED, TC-67 STREET SECTION CLOSED or a PVMS.

### Criteria for Use

AWS is relevant to all users of the route at the present time, therefore, more broadly applicable than ANS. AWS should be used where:

- There has been prior use of ANS.
- Critical capacity is reduced, or navigational freedom is restricted due to:
  - Continuous activity exceeding 48 hours duration.
  - Part-time, recurring activity during the same period (i.e., nightly lane closures) twice or more within 7 days.

### 4.3.1.3 Alternate Route Signing (ARS)

Signing installed on an affected route describing an alternative route to either reach a destination or to bypass congestion. The alternative route itself receives no temporary signing.

### Characteristics

- In combination with AWS, allow unfamiliar drivers to bypass the affected location.
- An alternative route is only termed a “detour” if it is formally signed with temporary trailblazers throughout the route. Unsigned routes are simply alternative routes.
- “Intercept” drivers on routes parallel to or crossing the affected route destined for the affected facility, channeling them onto alternative routes.
- Guide drivers to exit the affected facility along a detour or alternative route, returning them to their original route downstream of the work zone.
- Typically TC-62 ALTERNATE HIGHWAY ROUTE sign or two phase PVMS.

### Criteria for Use

ARS on all types of highways should be used where:

- Any restriction is imposed on navigational freedom. Some measure of access must be maintained if alternative routes are unavailable.
  - Directional information (i.e., Use Keele to Wilson) provided at the restriction site may be enough if the alternative routes are very straightforward and obvious.
  - Signing at decision-points along the detour route is required if the alternative routes are not straightforward and obvious.

- Critical capacity is reduced due to:
  - Continuous activity exceeding 7 days duration.
  - Part-time activity recurring four or more times during the same period (i.e., nightly lane closures) within 7 days.
- An AWS sign is located upstream.



## 4.4 Devices to Regulate and Control the Flow of Traffic

---

In some situations, guidance and information devices alone may not be adequate to ensure the safe and efficient movement of traffic. For example, where one lane is available for traffic in both directions, or where guidance through a complicated work zone is necessary, devices to control the flow of traffic are required.

The following sections provide descriptions of flow control devices, including their general application and limitations as well as guidelines and specifications once they have been identified, based on the fundamental and guiding principles described in Sections 2 and 3, and/or through a layout.

These sections are particularly relevant to:

- Designers, contractors, and road authorities in preparing or ordering a schedule of devices.
- Any person who is deploying the devices in reference to layouts.
- Supervisors or enforcement officers in evaluating the compliance of devices on site.

### 4.4.1 Yield to Oncoming Traffic

---

The YIELD TO ONCOMING TRAFFIC sign must be used only on two-lane, two-way highways, where only one lane is available for traffic. The sign advises highway users that they are required to give the right of way to oncoming traffic in the shared lane.

As specified in OTM Book 5 (Regulatory Signs), the sign may be used on highways where:

- Traffic volume is low.
- The work area is short.
- There is no obstructed visibility.

### 4.4.2 Traffic Control Persons (TCP)

---

Traffic Control Persons (TCP) are workers who manually regulate vehicle traffic using a TC-22 TRAFFIC CONTROL SIGN (STOP/SLOW Paddle), and often arm motions, to prevent conflicts between workers, work zone activities, opposing highway traffic, work vehicles, and pedestrians.

The TCP is responsible for:

- Protecting construction workers and the motoring public by safely regulating traffic flow and directing traffic through a work zone.
- Stopping traffic whenever required by the progress of the work; otherwise, to keep traffic moving at reduced speeds to avoid tie-ups and delays.

- Allowing construction to safely and efficiently proceed.
- Warning workers of impending danger.
- Ensuring that construction equipment does not impact public traffic.
- Focusing on the traffic control task and not performing other work while directing traffic.

Adequate safety precautions, as prescribed in the Occupational Health and Safety Act (OHSA), must be taken to protect TCP from any hazards to which they may be exposed. Safety precautions include:

- Personal protective clothing.
- Equipment and devices.
- Appropriate training.
- Additional protective measures necessary to mitigate risks imposed by vehicular traffic.

**NOTE**  
Adequate safety precautions as prescribed in the OHSA must be taken to protect TCP from hazards.

The safety of TCP must be addressed during the planning stages of traffic control.

### 4.4.2.1 Specifications for Use of TCP

**Table 4.5 Recommended Use for TCP**

Use	Roadway	Speed	Duration
Lane control (two-way traffic in single lane)	Non-freeways	≤ 60 km/h	All work durations
Lane control (two-way traffic in single lane)	Non-freeways	> 60 km/h and ≤ 90 km/h	Intermittent Duration (ID), Very Short Duration (VSD), and Short Duration (SD) for one day only
Within 30 metres of intersection if signals are turned off	Non-freeways	≤ 60 km/h	All work durations
Intermittently stopping traffic	For work progress	≤ 60 km/h	All work durations
Intermittently stopping traffic	To enter or cross non-freeways	≤ 60 km/h	All work durations

**NOTE**  
An additional TCP or two-way communication devices are required on sections where TCP are not in sight of each other.

TCP must not be used on:

- Any highway with a TC-12 FLASHING ARROW BOARD.
- A freeway or staged freeway including ramps.

TCP must never:

- Impact the operation of traffic control signals (temporary or permanent).
- Be positioned or operate within 30 metres of an intersection with operating traffic control signals. (Only Police Officers can control intersections with operating traffic control signals. (Refer to Section 175 (9) of the HTA)).

#### NOTE

TCP should never be positioned or operate within 30 metres of an intersection with operating traffic control signals.

Refer to the two decision matrices, [Table 4.10](#) and [Table 4.11](#) in [Section 4.4.6](#), to determine if the use of TCP is appropriate for the temporary condition.

On highway sections where TCP are not in sight of each other, an additional TCP and/or **two-way communication devices are required** to relay instructions to the TCP at each end.

### 4.4.2.2 TCP Qualifications and Equipment

General qualifications for a TCP include:

- Sound health, good vision and hearing, and mental and physical alertness.
- Mature judgement and pleasant manner.
- Ability to judge speed and distance of oncoming vehicles.
- Compliance with the OHSA requirement of a competent worker.
- Possession of a valid driver's licence (preferably).
- The ability to give motorists simple directions, explain hazards, and answer questions.
- The ability to appreciate, understand, and respect the responsibilities of the job.

#### NOTE

TCP must be given written and oral instructions about their duties in a language that they can understand.

TCP must be given written and oral instructions about their duties in a language they can understand.

## Clothing

TCP must wear a garment that covers at least his or her upper body and meet the requirements of *O.Reg. 213/91 Section 69.1* under the OHSA.

- The garment shall be fluorescent blaze or international orange in colour.
- On the front and the back, there shall be two yellow stripes that are 5 centimetres wide. The yellow area shall total at least 500 square centimetres on the front and at least 570 square centimetres on the back.
- On the front, the stripes shall be arranged vertically and centred and shall be approximately 225 millimetres apart, measured from the centre of each stripe. On the back, they shall be arranged in a diagonal “X” pattern.
- The stripes shall be retro-reflective and fluorescent.
- If the garment is a vest, it shall have adjustable fit and shall also have a side and front tear-away feature.
- For more detailed information on High Visibility Safety Apparel (HVSA), refer to CSA Z96-15 standard.

### TCP also require the following:

- A hard hat that is *Canadian Standards Association (CSA) certified Class E – Type I or II* hard hat. If used at night, it is recommended the hard hat have reflective tape that does not alter the dielectric properties of the safety hat and is visible from all angles (minimum of 80 cm<sup>2</sup> recommended).
- Safety boots that are *CSA-certified, Grade 1* (green triangular CSA patch on the outside, green rectangular label on the inside).
- Eye protection, e.g., clear safety glasses for night or overcast, tinted safety glasses when sunny, consider goggles for extreme dust and wind.
- Retro-reflective silver stripes encircling each arm and leg or equivalent side visibility-enhancing stripes with a minimum area of 50 cm<sup>2</sup> per side during night-time hours.

## Tools

The standard TC-22 TRAFFIC CONTROL SIGN (STOP/SLOW Paddle) with an extension handle must be used by TCP for hand signalling to direct traffic. The use of flags is prohibited.

Figure 4.7 Traffic Control Person Use of STOP/SLOW Paddle illustrates the TCP use of the STOP/SLOW paddle.

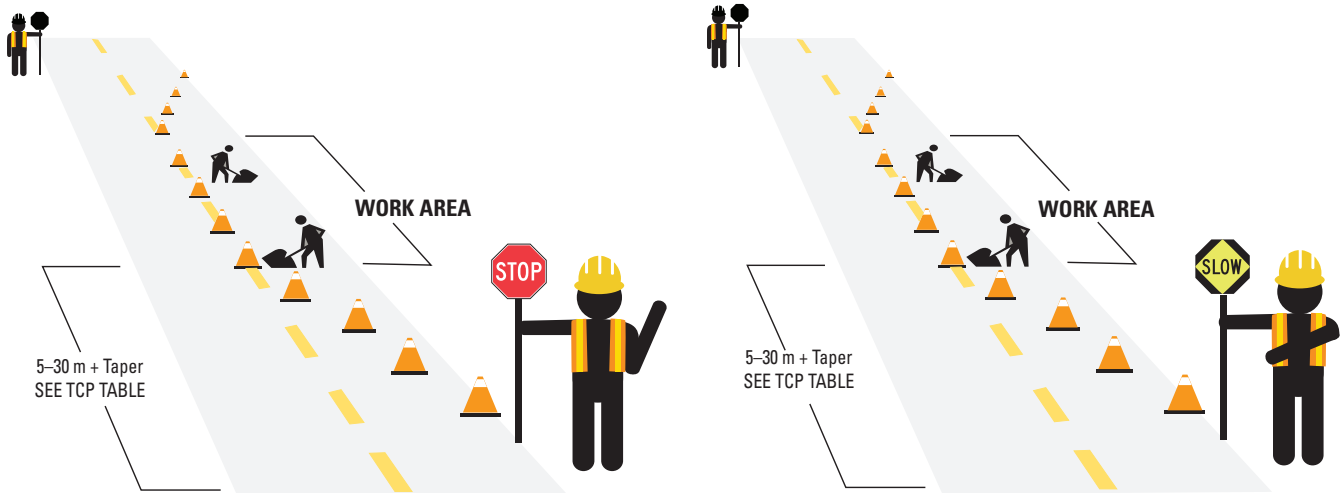

TCP may be used for night-time operations; however, this should be avoided if possible. Traffic Control Plans using TCP for night-time operations require approval from the road authority.

For night-time traffic control, TCP require:

- A well-lit TCP station. Appropriate lighting must be provided so that the TCP is clearly visible to traffic in both directions. Illumination from above is generally more effective than from the side.
- A TC-22 TRAFFIC CONTROL SIGN (STOP/SLOW Paddle) and a flashlight with a red or orange cone attachment with spare batteries.
- The STOP side of the paddle may be enhanced with alternating flashing red LED lightbars installed horizontally above and/or below the outer border of the STOP sign, as an option to the standard TC-22.
- The alternating flashing red light(s) are to be briefly activated by the TCP as vehicles approach to enhance conspicuity.
- **A two-way communication device.** Voice activated radios are recommended to free the TCP's hand for using the STOP/SLOW Paddles and flashlight simultaneously.
- Advance warning signs, which may be enhanced with amber beacons when TCP are used at night.
- Automated Flagger Assistance Devices (AFAD) or Portable Temporary Traffic Signal (PTTS) should be considered for high risk situations.

### 4.4.2.3 TCP Position and Location

When a TCP is on duty, the TC-21 TRAFFIC CONTROL PERSON AHEAD sign must always be used. The sign is placed in advance of the TCP at the distance shown in an appropriate layout in [Section 6](#). The TC-21 sign must be removed when the TCP is not on duty.

TCP must be positioned and operate in a manner which will not conflict with other traffic control devices such as:

1. STOP signs.
  - STOP signs must be covered on any approach that is controlled by a TCP.
2. Traffic signals.
  - Sufficient vehicle storage should be available between an intersection and the TCP to accommodate expected queues without extending into an intersection with operating signals.
  - Where there are operating traffic signals (permanent or temporary) at an intersection, TCP must not be used within 30 metres of the stop bar on any approach.
3. Railway crossing signals.

Lane closure tapers for one-lane and two-way lane control scenarios (when TCP or other traffic control devices are used) range from 15 metres to 30 metres (based on Normal Posted Regulatory Speed ), as shown in [Table 4.6](#), below.

[Table 4.6](#) also shows appropriate lengths of longitudinal buffer areas (LBA) at various NPRS.

For one-lane, two-way lane control scenarios, LBA:

- Should be used for all NPRS if space permits.
- Are required for NPRS > 60 km/h.
- Are recommended, if space permits, for NPRS < 60 km/h.

Additionally, TCP must be positioned 10 metres from the first cone of the taper. This distance remains constant at all NPRS.

#### NOTE

TCP must be positioned and operate in a manner which will not conflict with other traffic control devices.

#### NOTE

A TCP must not be used within 30 metres of the stop bar on any approach of an operating traffic signal.

**Table 4.6 Recommended TCP Positioning Distances**

NPRS (km/h)	50	60	70	80	90
Taper (m)	15	20	25	30	30
LBA (m)	(30)*	(40)*	50	60	75
TCP Position from First Cone (m)	10	10	10	10	10

\*LBA at speeds of 60 km/h or lower are optional; however, should be used if space permits.

Contractors are not permitted to turn off traffic signals to allow the use of TCP at an intersection. The turning off of traffic signals must be approved and executed by the road authority.

TCP must be clearly visible to approaching motorists at all times. This can be achieved by

- Locating the TCP for good visibility and contrast.
  - The TCP should not stand in the shadows or where the sun impedes visibility.
  - Colour contrast should be maintained between the TCP and the background, to every extent possible.
- Preventing other illuminated or reflective objects from distracting the visual attention of motorists away from the TCP.

Typical TCP locations are shown in [Figure 4.8 Positioning of Traffic Control Persons](#) for straight highway, hill, and curve situations, and in the layouts in [Section 6](#).

When a TCP is on duty, they must also:

- Be alert, standing at all times.
- Be aware of an escape route, which should be planned before going on duty.
- Face oncoming traffic and not turn their back on moving traffic.
- Stand alone and not mingle with workers or the public.
- Stand just outside the lane of traffic.
- Stand where they can be seen to give approaching traffic adequate time to respond, and where they can see for 150 metres.
- Remove or cover all signs that indicate a TCP (TC-21 TRAFFIC CONTROL PERSON AHEAD) when a TCP is not present to control traffic, including lunch and other breaks.
- Not perform any other work while directing traffic.

**NOTE**

The turning off of traffic signals must be approved and executed by the road authority.

**NOTE**

When a TCP is not present, including lunch and other breaks, the TC-21 sign must be removed or covered.

- Be alert for emergency vehicles, which have “priority rights,” and allow them to pass as quickly as possible.
- Conduct their operations so as not to impact nearby traffic control and railway crossing signal systems, and not override or conflict with them.

**Figure 4.8 Positioning of Traffic Control Persons**

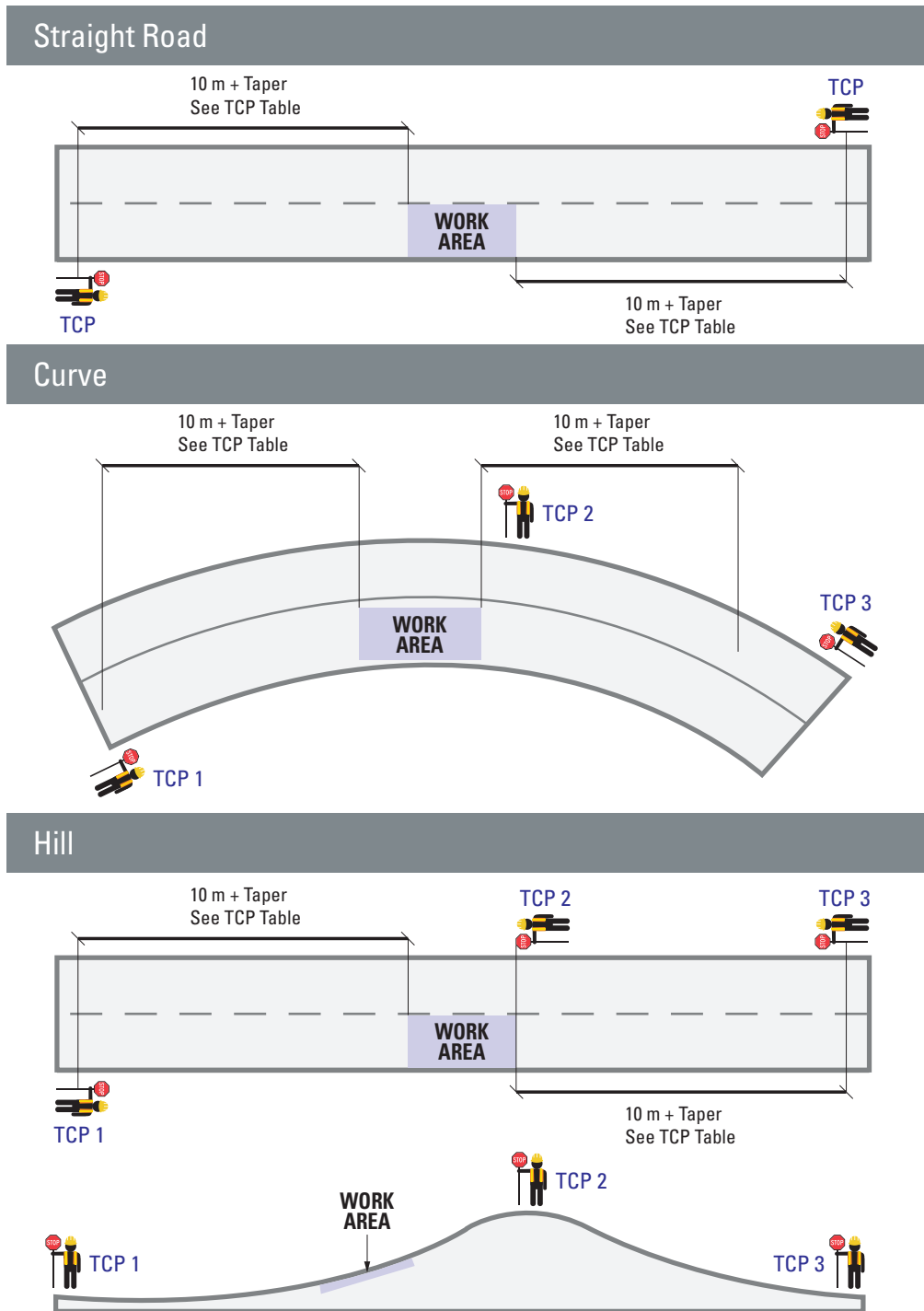



#### 4.4.2.4 TCP Control Procedures

The following procedures are to be used by TCP when controlling traffic.

When stopping traffic, the TCP must:

- Display the TC-22 STOP Paddle sign to the driver, extending the sign into the lane of oncoming traffic, giving the driver enough warning for a safe and comfortable stop.
- Stand off the travelled portion of the highway until the first vehicle has come to a stop.
- Move to a point on the highway where traffic in the queue can see him/her when traffic has stopped.
- Ensure that opposing traffic has stopped and the last opposing vehicle has passed his/her post before moving traffic from a stopped position.

When slowing traffic, the TCP must:

- Display the TC-22 SLOW Paddle sign, slowly moving the sign back and forth, if necessary, using hand signals to wave traffic forward or to command a further reduction in speed.

The most typical TCP situation involves two TCP. When two TCP are required:

- Lines of communication must be established prior to the start of operations.
- The two TCP must be able to see and hear each other or have two-way radios for proper communication.
- One TCP should be the lead TCP and coordinate all activities.

When using visual communications on curves or hills, a third TCP may be required to relay signals between the two TCP at the ends of the work area.

A single TCP may be used to control traffic in work areas where:

- The length of the closed lane is short (up to 50 metres).
- Traffic volumes and speeds are low. (NPRS 60 km/h or lower)
- Visibility is good and in daylight hours only.

This may only be done in such a way that it is effectively one-way control, such as where traffic in one direction has an unobstructed lane. In this case:

- The TCP holds traffic in the obstructed lane until the unobstructed lane is clear of traffic.

In this one-way control situation, the TCP serves the same function as the YIELD TO ONCOMING TRAFFIC sign.

### 4.4.3 Temporary Traffic Control Using Signals

Signals may be used as an alternative to TCP to control the flow of traffic through a work zone. There are currently four different electronic traffic control devices, which incorporate signal heads, that can be used to control traffic under temporary conditions.

1. Automated Flagger Assistance Devices.
2. Portable Lane Control Signals.
3. Portable Temporary Traffic Signals.
4. Temporary Traffic Signals.

Descriptions, guidelines, and specifications for their use on provincial highways are detailed in the sections below.

#### 4.4.3.1 Automated Flagger Assistance Devices (AFAD)

An Automated Flagger Assistance Device (AFAD) as defined in Section 146.1 (7) of the Highway Traffic Act as a self-contained, portable traffic control system that is operated remotely by a Traffic Control Person to control traffic movement and features a circular red lens, a circular yellow lens and a gate arm. This device should not be confused with a Portable Lane Control Signals (PLCS).

The AFAD is intended to be used as a supplement for TCP to control two way traffic on two lane highways which have been reduced to one lane during ID, VSD, or SD work.

AFADs should only be operated by a TCP who has been trained on the use and operation of the AFAD, and the TCPs shall not leave the AFAD(s) unattended at any time while they are operational.

An AFAD should be considered where the safety of the TCP on the highway has been identified as a concern. Safety benefits include:

- Operation by remote control allowing the TCP to stand off the highway and out of danger from passing vehicles or construction vehicles.
- Increased visibility. Drivers may see an AFAD at a further distance than a TCP, providing them with more time to slow down and stop. However, compliance with an AFAD may not be as high as with a TCP.

## Design

Every AFAD shall consist of a gate arm, and a signal head that contains one red lens mounted above one amber lens and each lens shall be at least 30 cm in diameter (HTA Regulation 185/22).

The signal lenses shall be mounted with a black backboard that is not less than 85 cm in height and not less than 50 cm in width, has an orange retro-reflective border that must be a minimum of 2.5 cm in width and is placed such that the bottom of the backboard is at least two meters above the level of the roadway (HTA Regulation 185/22).

The gate arm shall be at least 2 meters in length and at least 10 cm wide and shall be covered on both sides with alternating vertical stripes of orange and black retro-reflective sheeting. When the gate arm is lowered, the bottom edge of the gate arm shall not be less than 110 cm but not more than 140 cm above the level of the roadway (HTA Regulation 185/22).

The AFAD should have a conflict monitoring capability that prevents illumination of the red and amber lenses at the same time.

The Figure below illustrates the legal design requirements for an AFAD.

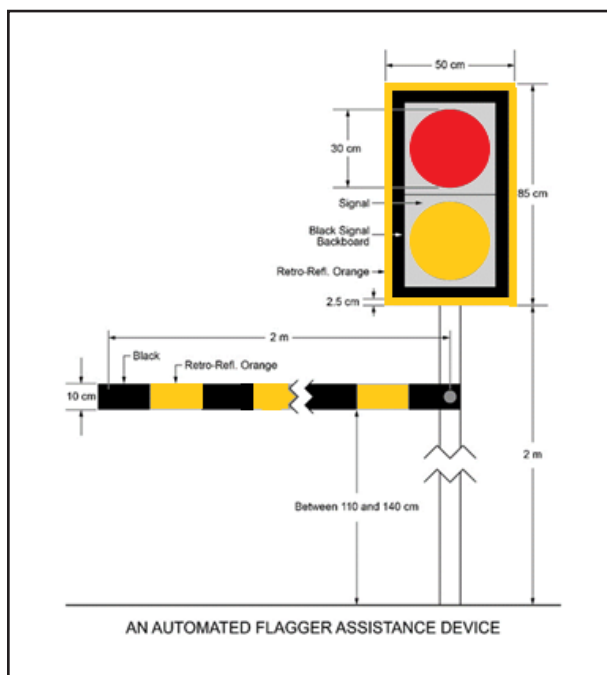

## Operation and Maintenance

An AFAD shall not be operated such that the amber and red lens are illuminated at the same time (HTA Regulation 185/22).

For road users to proceed through the one-lane section, the AFAD shall display a flashing amber indication with the gate arm in the up position. To stop vehicles, the AFAD must first sequence to a solid amber indication with the gate arm remaining in the up position, which would then be followed by a solid red indication with the gate arm in the down position. (HTA Section 146(3.1) and (4.1)).

### NOTE

Refer to the two decision matrices in [Section 4.4.6](#), [Table 4.10](#) and [Table 4.11](#), to determine if the use of AFAD is appropriate for the temporary condition.

The solid amber display is a change interval used to warn road users they are about to lose their right of way and be required to stop. This solid amber change interval should be between 4 and 6 seconds in duration.

Each lamp and each lens in the AFAD shall be maintained so that when the lamp is illuminated, the lens is clearly visible to approaching traffic for a distance of at least 165 meters (HTA Regulation 185/22).

An AFAD shall not be operated unless a TCP is positioned close enough to the device to enable the TCP to immediately display a traffic control stop/slow paddle to approaching traffic if the device malfunctions (HTA Regulation 185/22). Based on this legal requirement, two TCPs are always required and could operate the AFADs as follows:

1. One TCP operates an AFAD at either end of the work zone, or
2. One TCP operates an AFAD at one end of the work zone and the second TCP controls traffic with a TC-22 STOP/SLOW paddle at the other end of the work zone.

For both options, the TCPs should be in constant communication with each other.

If two AFADs are being used, the two devices can be connected. One TCP can control both AFADs to eliminate the possibility of conflicting commands being given to the devices. Both TCPs must still be close enough to their respective AFAD that they can see/recognize a malfunction and use a TC-22 STOP/SLOW paddle to control traffic if required.

A TCP responsible for operating or monitoring the AFAD should position themselves off the roadway and upstream of the device so they can observe the signal display safely.

A TCP shall not activate the flashing amber display until the last vehicle from the opposing direction has cleared the work zone.

### **Placement**

An AFAD shall be placed on a highway such that the device's signal is to the right of, facing and clearly visible to approaching traffic (HTA Regulation 185/22).

An AFAD shall not be located at an intersection or pedestrian crossover and shall not be located in any place or manner so as to conflict with any traffic control signal system (HTA Regulation 185/22).

Traffic should be channeled into a single lane in advance of the AFAD by means of cones, barrels, and an Rb-25 (KEEP RIGHT sign)

Proper illumination is required when AFAD are used for night-time activities.

The AFAD should be positioned in a location where the end of the arm reaches at least to the center of the lane being controlled.

A 60 cm square fluorescent orange flag may be attached at, or near, the end of the gate arm to make the gate arm more conspicuous.

If a contractor leaves the site, AFADs must be removed, and two-way flow of traffic resumed.

Refer to the two decision matrices in [Section 4.4.6](#), [Table 4.10](#) and [Table 4.11](#), to determine if the use of an AFAD is appropriate for the temporary condition.

## Signs

The following signs shall be erected in front of an AFAD in the order as listed below as a driver approaches the work zone (HTA Regulation 185/22):

- An Rb-31 DO NOT PASS sign as prescribed in Regulation 615 of the HTA
- An TC23B AUTOMATED FLAGGER ASSISTANCE DEVICE AHEAD sign.
- An Rb-78 “STOP HERE ON RED SIGNAL sign indicating the location where the driver approaching an AFAD device is to bring their vehicle to a stop.

These signs shall have a retroreflective background and be located to the right of, facing and clearly visible to approaching traffic (HTA Regulation 185/22).

Each sign shall be either:

- ground mounted, where the bottom of the sign shall be between 1.5 meters and 2.5 meters above the level of the roadway (HTA Regulation 185/22) or
- mounted on a portable stand, where the bottom edge of the sign shall be between 1.0 meter and 2.5 meters above the roadway level (HTA Regulation 185/22).

If the AFAD is to be used in an area designated by the French Language Services Act and the municipality has passed a by-law under subsection 14(1) of that Act, the Rb-78 ‘STOP HERE ON RED SIGNAL’ sign must be replaced with a bilingual version. If however the AFAD is in an area designated by the French Language Services Act, but the municipality has not passed a by-law under subsection

14(1), of that Act, an English only, or a bilingual version of the Rb-79 STOP HERE ON RED SIGNAL sign can be used. (HTA Regulation 185/22).

Full signing for use of the AFAD should be in accordance with TS-19.

#### 4.4.3.2 Portable Lane Control Signals (PLCS)

Portable Lane Control Signals (PLCS) consist of at least one vehicle traffic signal head, normally mounted onto a movable pole/trailer, with programmable signal timing. The use of PLCS is an alternative to continuous flagging by TCP and are not to be confused with PTTS.

Where PLCS are used, the following guidelines and specifications apply:

- PLCS may only be used to control one-lane, two-way traffic flow for ID, VSD, or SD work where the posted speed is 60 km/h or less with a minimum signal visibility distance of 100 m, as shown in [Table 4.7 Signal Visibility Table](#). Other situations require the use of Portable Temporary Traffic Signals (PTTS) see [Section 4.4.4.3](#).
- PLCS are not to be used at an intersection or pedestrian crossover.
- PLCS are only to be used where there is no conflict with any existing signals or traffic control systems.
- PLCS must be removed and two-way flow of traffic resumed whenever the contractor leaves the site.
- Due to the temporary nature of these devices, legal drawings are not required by law; however, these devices must only be operated while the contractor is on site.
- PLCS must be installed in accordance with the requirements of Regulation 606 in the HTA, which covers the physical and signage requirements for these devices.
- Full illumination must exist if the closure continues at night.
- PLCS systems consist of at least one traffic signal head, normally mounted on movable poles/trailers at a minimum height of 2.75 metres from the highway surface to the bottom of the heads as shown in [Figure 4.9 Portable Lane Control Signal](#).
- PLCS with two signal heads are recommended, where practicable, with the second signal head located in the standard secondary head location.
- Phasing must be two-phase only, with the all red clearance interval sufficiently long to clear the previous approach lane of all vehicular traffic while travelling at the desired operating speed.

#### NOTE

The use of PLC is an alternative to continuous flagging by TCP, and not to be confused with PTTS.

#### NOTE

PLCS may only be used to control one-lane, two-way traffic flow for ID, VSD, or SD work where the posted speed is 60 km/h or less.

**Figure 4.9 Portable Lane Control Signal**

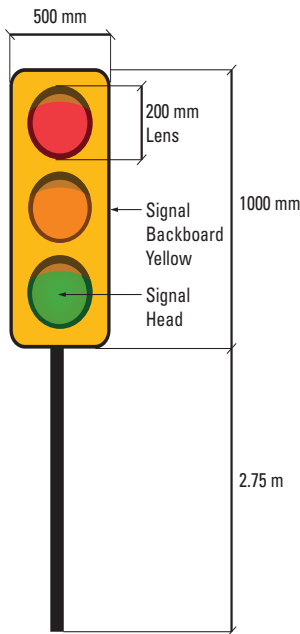

- Communication between the signal heads on opposite ends of the lane closure must be provided in order to prevent conflicting displays.
- Should conflicting displays occur, the system must ensure that both directions receive a solid red signal indication. [Figure 4.10 Signal Timing Calculations Examples](#) provides an example of signal timing calculations. Further information can be found in OTM Book 12.
- PLCS must be placed to the right of and facing traffic and used only under conditions where the signal lights are clearly visible to an approaching motorist such that the vehicle can be brought to a safe stop at the expected approach speeds
- Intensity of the signal lamps must be maintained in such manner that the lights are clearly visible for a distance of at least 100 metres (minimum requirement in the HTA).

- Access points or side streets within the one-lane section controlled by the PLCS must be controlled by TCP who are working in conjunction with the equipment.
- The signal system must be preceded by the following three signs:
  1. Rb-31 DO NOT PASS.
  2. TC-23 SIGNALS AHEAD.
  3. Rb-78 STOP HERE ON RED SIGNAL.

See [TS-16](#) and [Table A](#) or [Table B](#) in [Section 6](#), for the required placement. Driver action is prescribed in Section 146 of the HTA.

**Table 4.7 Signal Visibility Table**

Posted Speed (km/h)	Minimum distance from which signal must be clearly visible
60	110
70	140
80	170
90	200

Refer to the two decision matrices in [Section 4.4.6](#), [Table 4.10](#) and [Table 4.11](#), to determine if the use of PLCS is appropriate for the temporary condition.

### 4.4.3.3 Portable Temporary Traffic Signals (PTTS)

Portable Temporary Traffic Signals (PTTS) consist of two standard traffic signal heads mounted on movable trailers.

Where PTTS are used, the following guidelines and specifications apply:

- The road authority must approve the use of PTTS so they can monitor their operation and request that the contractor adjust the timing of the device if traffic flow is adversely affected
- For ID, VSD, and SD work, PTTS must be installed in accordance with the requirements of Regulation 606 in the HTA, which covers the physical and signage requirements. Driver action is prescribed by Section 146 in the HTA.
- PTTS may be used as lane control signals for ID, VSD, or SD work on highways with a NPRS greater than 60 km/h or for long duration work.
- For LD work:
  - PTTS must be installed to meet the requirements of Regulation 626 and Section 144 of the HTA.
  - PTTS should only be used for a maximum of 8 months (April - November), as maintenance and reliability concerns have been identified during the winter months. Outside this time period, the operation should return to normal two-way traffic flow.
  - A cost comparison is recommended to show that it is more cost effective to use solar powered PTTS as opposed to temporary traffic signals.
- PTTS must not be located in any place or manner so as to conflict with any existing signals or traffic control systems.
- Conventional Temporary Traffic Signals (TTS, i.e. signals on span wire) must be used instead of PTTS at entrances, truck access routes, or pedestrian crossings. If time of day functions are required due to known variances in traffic patterns (i.e., different maximum green times due to long weekend traffic patterns), a conventional temporary traffic signal is required.
- PTTS may be used as an alternative to TCP.
- Other traffic control devices required to supplement PTTS include:
  - Warning signs.
  - Regulatory signs.
  - Temporary pavement markings, and/or
  - Channelizing devices.

#### NOTE

PTTS may be used as an alternative to TCP.



- PTTS may not be used if a side street or access point is within a one lane section. Temporary signals with multiple phasing must then be used.
- There must be adequate visibility/sight distance as per [Table 4.7 Signal Visibility Table](#), without the use of auxiliary heads.
- If night-time use is required, illumination must be provided such that, as a minimum, the decision points on the approach to each end of the work zone where the signal heads are located are illuminated. This may be accomplished with portable generator powered lights that must be a minimum of 9.0 metres in height from the highway surface. The illumination provided by each light source shall be a minimum of 22,000 lumens and must not produce glare to oncoming motorists
- Trailers are typically positioned at intersections to emulate traffic control.
- PTTS trailers must:
  - Be strategically located so that they are protected from moving traffic.
  - Offer resistance to displacement or damage by moderate to severe weather, vehicle impact, and vandalism.
  - Be positioned in such a manner that the one signal head is adjacent to the highway while the other signal head is at least 0.5 metres to 1.75 metres into the approach lane.

**NOTE**

PTTS may not be used if a side street or access point is within a one lane section.

**NOTE**

When two PTTS are used within the same work zone, the maximum spacing recommended between the devices on a two-way, one-lane operation is 400 metres.

When two PTTS are used within the same work zone, the maximum spacing recommended between the devices on a two-way, one-lane operation is 400 metres.

- On MTO contracts the trailers shall not be used at intersections to emulate traffic control signals.
- For MTO projects, the Ministry's regional Traffic office must approve the use of PTTS systems, and all signal timing plans on a project-by-project basis.
- MTO requires an approved PHM-125 drawing for the installation of PTTS, to be completed for each stage of construction and including unique locations for:
  - Trailers.
  - Traffic signal heads.
  - Stop blocks.
  - Placement of barrier or detection devices.

**NOTE**

For MTO projects, the Ministry's regional Traffic office must approve the use of the PTTS system and all signal timing plans on a project-by-project basis.

**Material Requirements for PTTS**

PTTS devices must adhere to the following material requirement criteria when used on provincial highways:

- Must meet the physical display and operational criteria of conventional signals as specified in OTM Book 12.
- Must be listed on the Ministry's Designated Sources for Materials (DSM) list.
- Must be programmable as either a fixed-timed or actuated-timed operation.
- If the system is an actuated time operation unit, then it must utilize one or more of the following detection devices:
  - Microwave detection technology,
  - Loop detection technology, and/or
  - Video detection technology.

**General Hardware Requirements for PTTS**

PTTS devices must adhere to the following general hardware requirement criteria when used on provincial highways:

- Must have a mounting height capability of 5.0 metres for both primary and secondary signal heads on each trailer, measured from the highway surface to the bottom of the signal head backboard.
- Both traffic signals heads must be mounted at 5.0 metres, on all MTO contracts.
- The two signal heads shall be laterally separated at a minimum of 3.0 metres.
- All colour lenses must comply with the Institute of Transportation Engineers (ITE) interim/final specifications for incandescent or Light Emitting Diode (LED) lamps for chromaticity and luminous intensity.
- Signal heads must be reversible on the boom to allow trailers to be mounted on the same side of the highway and must be protected by barriers.
- Signal supports must consist of sturdy brackets that may be attached to a trailer.

**Trailer and Controller Requirements for PTTS.**

PTTS trailers and controllers must adhere to the following requirements:

- Each trailer unit must be able to operate either as a Master or Local.
- Each trailer must be interconnected by either hardwire or radio.
- The controller has circuitry which must detect low voltage and prevent the occurrence of an unsafe signal indication.
- In the event of low voltage, the signal must default to either a flashing or solid all red.

- The controller must provide a red flash cycle that is continuously flashed at a rate of 50-60 times per minute.
  - If a radio interconnection is used, the following Industry Canada requirements apply:
  - System must have a mobile license (if applicable).
  - Frequency and radio equipment must be approved for use in Canada.
  - Approval for the spread spectrum frequency band being used must meet requirements.
- The traffic signal controller must be equipped with a conflict monitor that monitors the Master and Local:
  - Absence of display.
  - Conflicting display on the same signal head or heads.
  - Conflicting displays on opposing heads.
- When a conflict is identified, or radio interference/failure occurs, the controller shall send out a message to the owner/operator via one or more of the following methods:
  - Cell phone technology.
  - Satellite technology, and/or
  - Email technology.
- All conflicts must be recorded in an error log with the exact date and time of the occurrence.
- The error log must be retrievable by the road authority.
- The controller must be password protected or have other security devices in place to prevent program tampering.

### **Power Supply for PTTS**

PTTS devices must adhere to the following power supply criteria when used on provincial highways:

- The generator/battery and other electronic controls must be completely inaccessible to unauthorized personnel and protected by a sturdy lockable metal enclosure.
- The unit must be alternatively powered by two or more (primary and back-up) of the following:
  - Generator.
  - Solar power.
  - Electrical power.
  - Battery (capacity must be enough to operate the system without recharging for a minimum of 14 days).

PTTS devices must adhere to the following green, yellow and red clearance interval requirements:

#### Green Clearance Interval Requirements

- The maximum and minimum green time must be user selectable.
- All timing intervals are capable of being set in increments of one second.
- For actuated time operations:
  - Vehicle extension time can be set in the signal controller.
  - If the detectors fail, the system places a constant call to the controller to ensure that it reaches the maximum green time for every cycle.

#### Yellow Clearance Interval Requirements

- Yellow clearance interval must be user selectable and consistent with OTM Books 7 and 12.

#### Red Clearance Interval Requirements

- Red clearance interval must be user selectable and consistent with OTM Books 7 and 12.
- The controller must be capable of providing a variable all red clearance interval between 0 - 600 seconds.

Refer to the two decision matrices in [Section 4.4.6](#), [Table 4.10](#) and [Table 4.11](#), to determine if the use of PTTS is appropriate for the temporary condition.

#### 4.4.3.4 Temporary Traffic Signals (TTS)

Temporary Traffic Signals (TTS) are normally comprised of traffic signal heads on span wires and temporary wood poles. They are intended to be used as an alternative to permanent traffic signals for limited periods prior to or during the re-construction of highways and have a constant power supply and more closely resembles a normal signal installation.

TTS must be used instead of PTTS at entrances, truck access routes, pedestrian crossings, or other fixed locations where required to temporarily replace existing signals. TTS must be used if time of day functions are required due to known variances in traffic patterns (i.e., different maximum green due to long weekend traffic patterns).

Where TTS are used, the following guidelines and specifications apply:

- Accessibility for Ontarians with Disabilities Act (AODA) pedestrian facilities should be maintained during construction.
- TTS installations require approval of the appropriate road authority.
- Design standards/specifications are the same as those that apply to permanent traffic signals as identified in OTM Book 12.

#### NOTE

TTS installations require road authority approval.

- Operational and timing requirements are the same as those for permanent signals.
- Adjustments to the signal timing may not be made unless pre-approved by the road authority.
- For use on Provincial Highways a PHM-125 drawing must be prepared and approved by the regional Traffic office prior to installation and activation as per HTA Section 144(31). Installations must comply with all regulations that pertain to traffic signals identified in HTA Regulation 626.
- A standard conflict monitor must be used to verify the operation of the Master and Local trailers. The conflict monitor must be capable of monitoring the Master and Local:
  - Absence of signal display.
  - Conflicting display on the same signal head or heads.
  - Conflicting displays on opposing heads.
- Temporary illumination using a standard design is required for all TTS installations

**Signal Timing Calculations for PTTS or TTS**

[Table 4.8 Service Volume at Signalized Single Lane Construction Sites \(Vehicles per Hour – One Way\)](#)

shows the service volumes at signalized single lane construction sites for a range of single lane lengths. [Table 4.8](#) can be used to determine the cycle lengths and all-red times required for a PTTS or TTS when used to alternate the right-of-way through a one-lane section of highway. Refer to OTM Book 12 (Traffic Signals) for more detailed information.

**Figure 4.10 Signal Timing Calculations Examples**

<b>Given:</b>	Heaviest approach volume (one-way) = 520 veh/h Length of single lane section = 150 m Operating speed = 40 km/h
<b>Find:</b>	Length of green interval (one direction), Length of all-red interval
<b>Solution:</b>	<p>By applying the given figures to <a href="#">Table 4.8</a>, we find that:</p> <ul style="list-style-type: none"> <li>a) Cycle length = 90 seconds</li> <li>b) All-red interval = 14 seconds</li> </ul> <p>The amber clearance from OTM Book 12 (Traffic Signals) formula calculated using a 1.8 second perception-reaction time is 3.6 seconds at 40 km/h. Round this value up to 4 seconds if the PTTS is unable to provide tenths of a second for the amber interval.</p> <p>Since the green time for each approach is equal to the cycle length, minus two all-red intervals (28 seconds), minus two amber intervals (8 seconds if minimum) divided by two, then the:</p> <p>Green Time (for each approach) = <math>(90 - (2 \times 14) - (2 \times 4))/2 = 27</math> seconds</p>

**Figure 4.7 Signal Timing Calculations Examples (Continued)**

<p>Not all single lane construction zones will have a speed of 40 km/h. The following describes how the timing of portable traffic signals at signalized single lane construction zones may be calculated for speeds other than 40 km/h.</p>	
<b>Given:</b>	<p>Heaviest approach volume (one-way) = Service Volume (vehicles per hour) = SV,                  Length of single lane = L</p>
<b>Find:</b>	<p>Length of green and amber intervals (one direction), Length of all-red interval</p>
<b>Solution:</b>	<ol style="list-style-type: none"> <li>3. Calculate the all-red interval, AR seconds  <math display="block">AR(s) = \text{Length of Single Lane (m)} / \text{Operating Speed (m/s)}</math> <math display="block">= 3.6 \times \text{Length of Single Lane (m)} / \text{Operating Speed (km/h)}</math> </li> <li>4. Choose a desired cycle length, C seconds (ranging from 40 to 150 seconds)</li> <li>5. Calculate the average vehicle arrival rate, VAR  <math display="block">VAR = SV \times C / 3,600</math> <p>Where VAR = average vehicle arrival rate obtained from <a href="#">Table 4.9 Vehicle Arrival Rates and Green plus Amber Times (Level of Service "E")</a> which shows the vehicle arrival rates for rural and urban conditions, for Level of Service (LOS) "E"</p> </li> <li>6. Calculate green + amber time for each approach, (G + A) seconds, from <a href="#">Table 4.9</a> for rural or urban conditions.  <math display="block">(G + A) \text{ (both approaches)} = C - AR - AR</math> <math display="block">(G + A) \text{ (one approach)} = (C - AR - AR) / 2</math> </li> <li>7. Green Time (G) = (G + A) - A (seconds)</li> </ol>
<b>Example</b>	
<b>Given:</b>	<p>Heaviest approach volume = 365 veh/h                  Length of single lane section = 150 m                  Operating speed = 25 km/h                  Amber = 3 s</p>
<b>Find:</b>	<p>Length of green and amber intervals (one direction), Length of all-red interval</p>
<b>Solution:</b>	<ol style="list-style-type: none"> <li>1. <math>AR = (3.6 \times 150) / 25 = 21.6 \text{ s}</math></li> <li>2. Choose cycle length of 90 seconds</li> <li>3. <math>AR = (365 \times 90) / 3,600 = 9.1 \text{ passenger cars per cycle per lane}</math></li> <li>4. (G + A) from <a href="#">Table 4.9</a> for rural conditions = 23 seconds</li> <li>5. Green time (G) = 23 - 3 = 20 seconds</li> </ol>

**Table 4.8 Service Volume at Signalized Single Lane Construction Sites (Vehicles per Hour – One Way)**

Length of Single Lane (m)	15	30	45	60	75	90	105	120	135	150	165	180	195	210	225	240	255	270	285	300	315	330	345	360	
"All Red" Interval One Way (sec)	2	3	4	6	7	8	10	11	12	14	15	16	18	19	20	22	23	25	26	27	29	30	31	33	
Cycle Lengths (seconds)	150	810	805	780	755	745	730	710	700	685	660	650	640	615	600	590	565	550	530	520	505	480	470	460	435
	140	800	785	770	745	735	720	695	685	670	645	630	620	595	580	565	540	530	505	490	475	450	440	425	405
	130	795	775	760	735	720	705	680	665	650	625	610	595	570	555	540	515	500	470	460	445	425	410		
	120	785	765	750	720	705	690	660	645	630	600	585	570	540	525	510	490	475	450	430					
	110	775	755	735	705	690	670	640	625	610	575	560	550	515	500	485	450								
	100	760	740	720	685	665	650	615	605	580	550	530	515	480	460										
	90	745	720	700	680	650	640	600	570	570	520	490	480												
	85	740	720	700	660	635	615	575	550	530	490	465													
	80	730	700	695	640	630	600	555	540	510	475														
	75	725	695	675	625	600	575	530	505	495															
	70	715	695	670	615	590	565	515	490																
	65	705	665	640	580	570	530	485																	
	60	695	660	630	570	540																			
	55	675	620	620	555																				
	50	660	615	580																					
	45	640	600																						
40	625																								

**Notes**

1. Operating speed of 40 km/h through a work area.
2. Minimum green approximately 15 seconds.
3. Minimum amber of 3 seconds.
4. Based on 50% probability.

**NOTE**

Table 4.8 gives the green and all-red time requirements for a specific speed through a construction zone of 40 km/h. When a PTTS or temporary signal is set up and turned on, a field review is required. The timing should be reviewed and modified, if necessary, as the speed of traffic through a construction zone may vary from that used to calculate the timing.

**Table 4.9 Vehicle Arrival Rates and Green plus Amber Times (Level of Service "E")**

Vehicle Arrival Rate (VAR) (vehicles/cycle)	Green + Amber (sec) Rural Intersections	Green + Amber (sec) Urban/Commuter Intersections
1	3.8	2.6
2	7.0	4.9
3	9.7	7.0
4	12.0	8.9

Vehicle Arrival Rate (VAR) (vehicles/cycle)	Green + Amber (sec) Rural Intersections	Green + Amber (sec) Urban/Commuter Intersections
5	14.2	10.8
6	16.4	12.7
7	18.6	14.6
8	20.8	16.5
9	23.0	18.4
10	25.1	20.2
11	27.2	22.0
12	29.3	23.8
13	31.4	25.6
14	33.5	27.4
15	35.6	29.2
16	37.7	31.0
17	39.8	32.8
18	41.9	34.6
19	44.0	36.4
20	46.0	38.2
21	48.0	40.0
22	50.0	41.8
23	52.0	43.7
24	54.0	45.6
25	56.0	47.5
26	58.0	49.4
27	60.0	51.3
28	62.0	53.2
29	64.0	55.1
30	66.0	57.0
31	68.0	58.9
32	70.0	60.8



Vehicle Arrival Rate (VAR) (vehicles/cycle)	Green + Amber (sec) Rural Intersections	Green + Amber (sec) Urban/Commuter Intersections
33	72.0	62.7
34	74.0	64.6
35	76.0	66.5

Refer to the two decision matrices in [Section 4.4.6](#), [Table 4.10](#) and [Table 4.11](#), to determine if the use of TTS is appropriate for the temporary condition.

**NOTE**

Each truck or bus is equivalent to 2 passenger cars.

#### 4.4.4 Traffic Control Using Moving Vehicles

Traffic control using moving vehicles can be achieved through the operation of:

- **Pilot** vehicles to guide highway users, at an appropriate speed, through a complex one-lane section of a temporary traffic control zone or detour on a two-lane highway.
- **Pace** vehicles to control the speed of vehicles through a construction site, where reduced speed is necessary, but difficult to achieve by other means.
- A rolling closure consists of pace vehicles used to hold back (restrain) all upstream traffic at a lower pace to create a gap in traffic of up to 15 minutes to complete an Intermittent operation (i.e. change traffic control, overhead sign install, debris removal).
- Road authority approval is required to operate pilot or pace vehicles except when pace vehicles are used to provide a short-term rolling closure for the set up or removal of traffic control devices.
- Where practicable the use of pilot or pace vehicles should be decided by the road authority prior to contract tendering.

**NOTE**

Road authority approval is required to operate pilot or pace vehicles except when pace vehicles are used to provide a short-term rolling closure for the set up or removal of traffic control devices.

The road authority must also make the decision whether to use:

- Police vehicles. Driver compliance is likely to be higher when paced by a police vehicle rather than a contractor vehicle.
- Road authority staff and their vehicles.
- Contractor staff and their vehicles.
- A combination of the above.

**NOTE**

It is the road authority's decision whether to use the police, its own staff, and/or contractors to act as pilot or pace vehicles.

If forces other than the police are used for traffic control with moving vehicles, adequate training should be provided to the staff who will operate these vehicles.

#### 4.4.4.1 Pilot Vehicles

Pilot Vehicles are used on a two-lane highway to guide a platoon of vehicles, at an appropriate speed, through a one-lane section of a complex temporary traffic control zone or detour.

Where pilot vehicles are used for traffic control, the following guidelines and specifications apply:

- The operation of pilot vehicles must include traffic controls at each end of the one-lane section, such as TCP, and one or two vehicles with communication links between them all.
- The pilot vehicle moves into the position at the head of the queue of vehicles about to be released by the TCP.
- When directed by the TCP, the pilot vehicle guides the vehicles through the work zone (Direction 1).
- At the far end of the one-lane section, beyond the work zone, the pilot vehicle pulls over at the earliest safe opportunity and signals the following queue to pass.
- When the last vehicle of the queue clears the one-lane work zone section, the pilot vehicle in the other direction (Direction 2) should follow the same procedure as outlined above. Preferably, two pilot vehicles are used for this operation, one in each direction, to reduce motorist delay and driver frustration.
- Alternatively, if traffic volumes are low, the pilot vehicle in Direction 2 may be the same pilot vehicle as in Direction 1 (which turns around at the end of the work zone and takes its position at the head of the queue).
- The pilot vehicle should display the name of the contractor or road authority. The TC-27 DO NOT PASS WHEN FLASHING sign must be mounted in a conspicuous location on the rear of the vehicle.
- Where significant queuing occurs or is expected to occur, or visibility at the end of the queue is insufficient, the TC-20 or TC-20A PREPARE TO STOP sign should be used upstream of the expected end of the queue.
- Two or more pilot vehicles may be used to guide two-way traffic through a particularly complex detour.
- Work vehicles that enter the work zone should be managed by the TCP so that they are the last vehicle(s) in the queue, to avoid other vehicles following them into the work area.

### 4.4.4.2 Pace Vehicles

Pace vehicles are used to control the speed of vehicles through a work zone where speed control is required but is difficult to achieve by other means.

Where pace vehicles are used for traffic control, the following guidelines and specifications apply:

- The deployment of pace vehicles is not simple or straightforward. Extra care must be taken to ensure that the use of pace vehicles is done safely.
- Where significant queuing and congestion are expected, or where pace vehicles must be deployed in low volume situations with vehicles approaching at high speed, advance signing should be provided to warn of possible stops or the use of pace vehicles.
- Caution and experience are necessary to effectively and safely apply pace vehicles in low volume, high speed traffic situations.
- The TC-27 DO NOT PASS WHEN FLASHING sign must be mounted in a conspicuous location on the rear of each non-police pace vehicle.
- Pace vehicle(s) must lead at a reasonable speed. The speed differential between vehicles that are approaching the work zone from upstream to the last vehicles in the queue must not create a collision hazard. A realistic speed reduction is 10 to 15 km/h below the NPRS.
- Good communication among pace vehicles is essential for good traffic control.
- Pace vehicles should only be used where there is a single lane through the work zone. One or more vehicles may be necessary to pace traffic through one or more lane closures to reach the single lane section.
- The pace vehicle(s) (one per lane) will enter the free-flowing traffic upstream of the first lane closure and downstream of any on ramps. The vehicles will gradually reduce speed and align with each other to prevent drivers from changing lanes to get in front of the pace vehicles.
- At the end of the taper, the pace vehicle in the closed lane should merge into the traffic behind the pace vehicle in the remaining open lane.

#### NOTE

Pace vehicles should only be used where there is a single lane through the work zone.

#### ***Determining the Number of Pace Vehicles Required***

A sufficient number of pace vehicles are required to provide continuous speed reduction to avoid end of queue collisions within a work zone.

When the last vehicle in a queue has entered the work zone, pace vehicle(s) must be in place to lead and pace the next vehicles through the work zone. This means that the time to traverse the work zone, plus the time required to circle back and take position back in the traffic stream, must be considered.

The number of pace vehicles (PV) required can be calculated as follows:

$$PV = N \times (\text{Cycle Time} / \text{Work Zone Traversal Time})^*$$

where:

*PV* = the number of pace vehicles needed

*N* = the number of lanes in the direction of interest in advance of any lane closures (assuming that only one lane is left open to traffic in the work zone).

*\*Work zone traversal time is the time required to drive through the work zone at the pace vehicle speed. Cycle time is the time required for a given pace vehicle to drive through the work zone, plus the time required to circle back to start another run through the work zone. The cycle time will be affected by traffic volume, and characteristics of the highway network; i.e., how directly and quickly a pace vehicle can drive around and return to the beginning of the work zone.*

For example, consider an operation with three lanes that are being progressively closed to one, with a work zone traversal time of 10 minutes, and a return time of 20 minutes from the end of the work zone back to the beginning. To avoid the risk of fast vehicles closing in on slow vehicles in the work zone, a new set of three pace vehicles will be required every 10 minutes.

$$\begin{aligned} N &= 3 \text{ lanes} \\ \text{Work Zone Traversal Time} &= 10 \text{ mins} \\ \text{Cycle time} &= 10 \text{ mins (Work Zone Traversal Time)} + 20 \text{ mins (return time)} \\ &= 30 \text{ mins} \\ PV &= 3 \text{ lanes} \times (30 \text{ mins}/10 \text{ mins}) \\ &= 9 \text{ pace vehicles.} \end{aligned}$$

### Determining the Number of Pace Vehicle Hours Required

Since the purpose of pace vehicles is to control traffic speed, they are not required during periods when traffic congestion alone results in traffic speeds at or below the desired speed. However, continuous observation of traffic conditions must be maintained so that they can be promptly re-introduced into the traffic stream when congestion eases and speeds increase.

To estimate the number of pace vehicle hours required over the duration of a contract:

1. Determine the number of pace vehicles needed (explained above).
2. Calculate the number of hours that the pace vehicles are required as the total hours that a reduced speed is desired, minus the hours during which congestion alone results in speeds of 15 km/h or more below the NPRS.
3. Pace vehicle hours = number of pace vehicles x hours
4. If there are multiple stages within a contract, the number of pace vehicles required will need to be calculated for each unique configuration. The total pace vehicle hours required

#### NOTE

Pace vehicles are not required during periods when traffic congestion alone results in speeds below the desired speed.

for the contract will be the sum of individually calculated pace vehicle hours for each configuration.

#### 4.4.4.3 Rolling Closures

Contractor vehicles may be used as pace vehicles in a rolling closure; however, driver compliance is likely to be higher when controlled by a police vehicle.

Police vehicles are recommended on high-volume highways (required on provincial freeways).

- The DO NOT PASS WHEN FLASHING sign (TC-27) must be mounted in a conspicuous location on the rear of all non-police pace vehicles used in a rolling closure.

Prevention of traffic moving past the rolling closure is critical to ensure worker safety.

Communication between pace vehicles and downstream workers must be in place to alert workers if the closure has been breached.

One of the following two approaches should be used for rolling closures:

##### 1. Urban freeways with frequent interchanges.

Drivers are generally accustomed to frequent congestion on urban high-volume freeways and it is neither desirable nor possible to prevent vehicles from entering the highway at all upstream entrance ramps.

- The rolling closure operation is initiated by lead pace vehicles travelling abreast, one vehicle per lane, several kilometers upstream of the closure site to control the flow and speed of traffic that is approaching the closure site.
- As the pace vehicles approach the site, they gradually reduce their speed allowing traffic ahead (downstream) of them to clear the work zone at a normal speed.
- After the pace vehicles pass the entrance ramps of the last upstream interchange, they continue to reduce their speed, coming to a complete halt, if necessary, just upstream of the closure site to create the necessary time window.
  - The slowing and stopping of the pace vehicles should be progressive and gradual so that drivers have time to adjust to the situation, as in a similar congestion situation.
- When the work at the closure site is complete, pace vehicles turn off their flashing lights and allow traffic to resume normal flow.

#### NOTE

Prevention of traffic moving past the rolling closure is critical to ensure worker safety.

##### Rural freeways with infrequent interchanges

Drivers expect free flow conditions on rural low volume freeways. A sudden requirement to come to a halt would violate driver expectation and present a hazard. Therefore, the pace vehicle(s) should

lead at a planned speed reduction of no more than 15-20 km/h below the NPRS and the use of advance warning signs, such as the PREPARE TO STOP sign (TC-20), should be considered. The distance upstream of the work zone where the rolling closure operation will be initiated must be calculated. The point of initiation must be further upstream than the distance travelled by the pace vehicles, at the planned speed, in the total time required to:

- a) Clear the last unrestrained vehicle from the work zone.
- b) Perform the work.
- c) Clear workers from the roadway.

This distance may be as great as 15 km to 25 km. This means that a rolling closure is unlikely to be suitable in all situations but must be carefully tailored to the road configuration and network involved.

- The rolling closure operation is initiated by lead pace vehicles travelling abreast, one vehicle per lane, to control the flow and speed of traffic that is approaching the closure site.
- As the pace vehicles approach the site, they gradually reduce their speed, allowing traffic ahead (downstream) of them to clear the work zone at a normal speed.
- As the rolling closure is approaching the work zone, all entrance ramps at the intermediate interchanges must be closed until the rolling closure has passed to prevent vehicles from entering the clear zone ahead of the lead pace vehicles.
- If the rolling closure starts more than one interchange back, it may be desirable for the lead pace vehicles to drive at a speed closer to the normal posted speed until they have passed the last interchange, and then decelerate to a lower speed when it is no longer possible for entrance ramp traffic to pass them or enter ahead of them.
- All work vehicles involved in the rolling closure, including lead pace vehicles, vehicles at intermediate interchange entrance ramps, and at the work area itself, be in good communication with each other to alert workers if the closure has been breached.
- When the work operation is complete, the lead pace vehicles may speed up, at or beyond the work zone, and merge into one lane, permitting other traffic to pass them.
- If the work operation includes the set-up of a lane closure, the lead pace vehicle in the closed lane should merge behind the lead pace vehicle in the open lane at the end of the taper.
- In some circumstances, it may be necessary or desirable to bring vehicles to a very low speed or even to a stopped position. This need may arise if operations at the work area run into unexpected difficulties and require more time. Where very low speeds or stops are planned or can be reasonably anticipated to be required, advance signage such as the PREPARE TO STOP sign (TC-20), should be used.

**NOTE**

On rural low volume freeways, the pace vehicle should lead at a speed no less than 15-20 km/h below the NPRS.

**NOTE**

All work vehicles involved in the rolling closure should be in good communication to alert workers if the closure has been breached.

## 4.4.5 Paid Duty Police Officers

When paid duty police officers are present, driver compliance with traffic control devices is likely to be higher and observed speed lower. The use of paid duty police officers may be specified in a Traffic Control Plan to provide the following tasks:

- **Enforcement** – layout of a temporary configuration often presents challenges to effective enforcement. The road authority, contractor, and police should discuss expectations and procedures prior to beginning the work.
- **Authority** – where enforcement is not practicable, the presence alone of paid duty officers and an enforcement vehicle in the work zone have proven to be effective measures to help manage speed and increase compliance with traffic control measures. The location and schedule should be determined in advance. The effectiveness should be monitored and modified if issues are identified.

**Traffic direction at intersections** - Paid duty officers must be used to control traffic within 30 metres of an intersection with operating signals. If traffic does not need to be controlled at the intersection, however, paid duty officers are not required.

**Traffic control with moving vehicles** – the road authority may specify the use of paid duty officers and police vehicles to be used for pace or pilot vehicles, or conduct rolling closures. Where paid duty police officers are used, the following guidelines and specifications apply:

- Early and ongoing communication between the road authority, workers, and paid duty police officers is important for the effective planning and coordination of traffic control procedures.
- Before work begins, paid duty officers should be provided with information on their roles and responsibilities as well as those of the road authority and workers in the work zone.
  - This exchange can be carried out during a pre-construction meeting between the paid duty officer and the road authority. The pre-construction meeting should identify the best approach for enforcement.
- A safe location to carry out enforcement should be identified. In a stationary work zone, where practicable, paid duty officers should be located on the shoulder, before the taper begins.
- The paid duty officer should be provided with a point of contact in the field to notify of any deficiencies, potential problems, or hazardous conditions observed.

### NOTE

Paid duty officers must be used to control traffic within 30 metres of an intersection with operating traffic control signals. See [Section 4.4.2](#) on TCP.

### NOTE

Before work begins, paid duty officers should be provided with information on their roles and responsibilities as well as those of the road authority and workers in the work zone.

- When deployed in a temporary work zone, paid duty officers should:
  - Review the Traffic Control Plan to identify possible issues that may impede their operation.
  - Drive through the work zone from both directions and note all entranceways. This will help the officer become familiar with the work zone.
  - Maintain visibility by turning on the emergency lights in place of headlights on their vehicles and wearing a retroreflective safety vest while outside of the vehicle.
  - Observe traffic conditions at all times while in the work zone.
- Training of paid duty police officers in the application of OTM Book 7 is recommended to improve their knowledge of traffic control in temporary work zones.
- Paid duty officers must comply with Ministry of Labour, Trades and Skills Development (MLTSD) requirements to wear appropriate personal protective equipment (PPE).

Refer to the two decision matrices in [Section 4.4.6](#), [Table 4.10](#) and [Table 4.11](#), to determine if the use of paid duty police officers is appropriate for the temporary condition.

#### 4.4.6 Decision Matrices for the Use of Devices to Regulate and Control the Flow of Traffic

---

Table 4.10 and Table 4.11 are decision matrices that clearly define the usage criteria for TCP and other traffic control devices.

The two matrices are sorted according to their traffic activity.

- [Table 4.10](#) is to be used for lane control (regulating alternating two-way traffic in a single lane).
- [Table 4.11](#) is to be used for intermittently stopping public traffic for workers or construction vehicles to enter or cross a highway.

Acronyms used in the tables are defined as follows:

NPRS = Normal Posted Regulatory Speed

ID = Intermittent Duration

VSD = Very Short Duration

SD = Short Duration

LD = Long Duration

TCP = Traffic Control Person

AFAD = Automated Flagger Assistance Device

PLCS = Portable Lane Control Signal

PTTS = Portable Temporary Traffic Signal

TTS = Temporary Traffic Signal

PDO = Paid Duty Officer



**Table 4.10 Permissible Traffic Control for Alternating Two-way Traffic in Single Lane**

Highway Characteristics	NPRS (km/h)	Duration	Traffic Control Device						
			Yield <sup>2</sup>	TCP	AFAD <sup>5</sup>	PLCS <sup>5</sup>	PTTS <sup>4</sup>	TTS <sup>4</sup>	PDO
<ul style="list-style-type: none"> <li>• Non-freeway<sup>1</sup> reduced to one lane. (alternating two-way traffic flow).</li> <li>• Not at intersection.</li> <li>• Not at a pedestrian crossover.</li> </ul>	≤60	ID	✓	✓	✓	✓	✓	✓	✓
		VSD	✓	✓	✓	✓	✓	✓	✓
		SD	✓	✓	✓	✓	✓	✓	✓
		LD	✓	✓	-	-	✓	✓	✓
	>60 & ≤90	ID	✓	✓	✓	-	✓	✓	✓
		VSD	✓	✓	✓	-	✓	✓	✓
		SD	✓	✓ <sup>6</sup>	✓	-	✓	✓	✓
		LD	✓	-	-	-	✓	✓	✓
<ul style="list-style-type: none"> <li>• Non-freeway<sup>1</sup> reduced to one lane (alternating two-way traffic flow).</li> <li>• At intersection without permanent traffic signals; or at pedestrian crossover</li> </ul>	≤60	ID	-	✓	-	-	✓	✓	✓
		VSD	-	✓	-	-	✓	✓	✓
		SD	-	✓	-	-	✓	✓	✓
		LD	-	✓	-	-	✓	✓	✓
	>60 & ≤90	ID	-	✓	-	-	✓	✓	✓
		VSD	-	✓	-	-	✓	✓	✓
		SD	-	✓ <sup>6</sup>	-	-	✓	✓	✓
		LD	-	-	-	-	✓	✓	✓

Highway Characteristics	NPRS (km/h)	Duration	Traffic Control Device						
			Yield <sup>2</sup>	TCP	AFAD <sup>5</sup>	PLCS <sup>5</sup>	PTTS <sup>4</sup>	TTS <sup>4</sup>	PDO
<ul style="list-style-type: none"> <li>Non-freeway<sup>1</sup> reduced to one lane (alternating two-way traffic flow).</li> <li>At intersection with permanent traffic signals</li> </ul>	≤60	ID	–	–	–	–	–	✓	✓
		VSD	–	–	–	–	–	✓	✓
		SD	–	–	–	–	–	✓	✓
		LD	–	–	–	–	–	✓	✓
	>60 & ≤90	ID	–	–	–	–	–	✓	✓
		VSD	–	–	–	–	–	✓	✓
		SD	–	–	–	–	–	✓	✓
		LD	–	–	–	–	–	✓	✓

**Table 4.10** Notes:

- This table refers to non-freeway highways. The traffic control devices included in this table are not permitted to be used on freeways.
- "Yield to oncoming traffic" control can only be used on highways with low traffic volumes (< 3,000 veh/day) and for work areas short in length (< 150 m).
- Road authorities may specify TTS be used in place of PTTS for LD setup. TTS should be used in place of PTTS during winter months.
- PTTS and TTS cannot be used in conjunction with TCP (within 30 m). If further direction is required beyond the signal devices and associated signage, PDO must be used as TCP.
- Where PLCS or AFAD are used for lane control, any driveways or side streets within the one-lane section must be controlled by TCP working in conjunction with the equipment.
- TCP can be used for SD work on highways with NPRS ≤ 90 km/h for one day only. If the work zone will be in place for more than one consecutive day, TCP cannot be used.

**Table 4.11 Permissible Traffic Control for Intermittently Stopping Public Traffic**

Highway Characteristics	NPRS (km/h)	Duration	Traffic Control Device						
			Yield	TCP	AFAD	PLCS	PTTS	TTS	PDO
<ul style="list-style-type: none"> <li>• Undivided highway<sup>1</sup>.</li> <li>• Up to one open lane in each direction.</li> <li>• TCP not located within 30 m of intersection with operating traffic signals<sup>2</sup>.</li> </ul>	≤60	ID	–	✓	–	–	–	–	✓
		VSD	–	✓	–	–	–	–	✓
		SD	–	✓	–	–	–	–	✓
		LD	–	✓	–	–	–	–	✓
	>60 & ≤90	Any Duration	Not permitted under normal circumstances. Road Authority has discretion; PDO should be used.						
<ul style="list-style-type: none"> <li>• Undivided highway<sup>1</sup>.</li> <li>• More than one open lane in either direction.</li> <li>• TCP not located within 30 m of intersection with operating traffic signals<sup>2</sup>.</li> </ul>	Any NPRS	Any Duration	Not permitted under normal circumstances. Road Authority has discretion; PDO should be used.						
<ul style="list-style-type: none"> <li>• Divided highway<sup>1</sup>.</li> <li>• Up to one open lane in TCP-controlled direction.</li> <li>• TCP not located within 30 m of intersection with operating traffic signals<sup>2</sup>.</li> </ul>	≤ 60	ID	–	✓	–	–	–	–	✓
		VSD	–	✓	–	–	–	–	✓
		SD	–	✓	–	–	–	–	✓
		LD	–	✓	–	–	–	–	✓
	> 60 & ≤ 90	Any Duration	Not permitted under normal circumstances. Road Authority has discretion; PDO should be used.						
<ul style="list-style-type: none"> <li>• Divided highway<sup>1</sup>.</li> <li>• More than one open lane in controlled direction.</li> <li>• TCP not located within 30 m of intersection with operating traffic signals<sup>2</sup>.</li> </ul>	Any NPRS	Any Duration	Not permitted under normal circumstances. Road Authority has discretion; PDO should be used.						

Highway Characteristics	NPRS (km/h)	Duration	Traffic Control Device						
			Yield	TCP	AFAD	PLCS	PTTS	TTS	PDO
<ul style="list-style-type: none"> <li>Divided or undivided highway<sup>1</sup>.</li> <li>Up to one open lane in each direction; or up to one active traffic lane in controlled direction on divided highways.</li> <li>TCP located within 30 m of intersection with operating traffic signals<sup>2</sup>.</li> </ul>	≤ 60	ID	-	-	-	-	-	-	✓
		VSD	-	-	-	-	-	-	✓
		SD	-	-	-	-	-	-	✓
		LD	-	-	-	-	-	-	✓
	> 60 & ≤ 90	Any Duration	Not permitted under normal circumstances. Road Authority has discretion; PDO should be used.						
<ul style="list-style-type: none"> <li>Divided or undivided highway<sup>1</sup>.</li> <li>More than one open lane in controlled direction; or more than one open lane in either direction on undivided highways.</li> <li>TCP located within 30 m of intersection with operating traffic signals<sup>2</sup>.</li> </ul>	Any NPRS	Any Duration	Not permitted under normal circumstances. Road authority has discretion; PDO should be used.						

**Table 4.11** Notes:

1. This table refers to non-freeway highways. The traffic control devices included in this table are not permitted to be used on freeways.
2. 'Operating traffic signals' means temporary or permanent traffic signals.

## 4.5 Positive Protection Devices

Proper use of guidance/information devices and flow control devices provide for the safe and efficient movement of traffic through a work zone. In addition, some temporary conditions may warrant the use of positive protection devices to prevent the intrusion of motorized vehicles into the workspace and other hazardous areas of the work zone.

The following sections provide a description of positive protection devices, including their general applications and limitations, MTO specifications, and guidelines.

### 4.5.1 Buffer Vehicle (BV)

A Buffer Vehicle (BV) is a truck placed upstream of a work area to provide protection for workers against an out of control vehicle approaching a work area.

- The BV should be unoccupied for stationary operations and may be equipped with a Truck or Trailer Mounted Attenuator (TMA).
- A BV without a TMA is defined as a Blocker Truck (BT).
- A BV with a TMA is defined as a Crash Truck (CT).
- A CT is preferred over a BT as the TMA reduces the risk of injury to the occupants of the incoming vehicle and to the CT driver.
- A BV requires a mounted TC-12 FLASHING ARROW BOARD and four-way flashers.



#### NOTE

A Crash Truck is preferred over a blocker truck as the truck mounted attenuator reduces the risk of injury.

For stationary operations, BV are typically used in combination with Longitudinal Buffer Areas (LBA).

- If a BV is used on a non-freeway, the appropriate LBA is required for stationary operations.
- On multi-lane highways with Normal Posted Regulatory Speed (NPRS) of 70 km/h or higher, a CT is recommended over a BT.

#### 4.5.1.1 Truck Mounted Attenuator (TMA) and Buffer Vehicle (BV) Requirements

##### Truck Mounted Attenuator (TMA) Requirements

An attenuator is an energy-absorbing device mounted onto the rear of a truck or trailer, which will deform upon impact in a controlled manner, thereby reducing the rate of:

- Deceleration (and associated injury) for the occupants of a vehicle which has struck the TMA from the rear.
- Acceleration (and associated injury) for the driver of the truck.

TMA, whether truck or trailer mounted, should be selected for the appropriate posted speed as noted below:

- All TMA used on freeways must satisfy the level TL-3 requirement (100 km/h). The 100 km/h reference relates to the testing speed, not the posted speed of the facility on which it is required for use.
- TMA must meet the requirements of AASHTO Manual for Assessing Safety Hardware (MASH) TL-3 or National Cooperative Highway Research Program (NCHRP) 350 Level TL-2 (70 km/h) or higher.
- All new TMA (replacements and new purchases) must be up to date to meet the MASH requirements.

### **Buffer Vehicle (BV) Requirements**

BV Weight:

CT used on MTO contracts must have:

- Minimum mass of 6,800 kg (15,000 pounds), excluding attachments or ballast.
- Maximum mass of 12,000 kg (26,400 pounds), including any ballast, flashing arrow boards, or TMA.

Trucks heavier than 12,000 kg may be used if the road authority considers acceleration/deceleration characteristics to be adequate or not an issue.

BV Ballast:

- If loose material, such as sand, is used as ballast, it must be kept below the level of the sides of the BV box.
- If solid objects, such as concrete blocks, are used, they must be attached to the truck body in such a manner as to withstand a major impact without breaking free of their attachments.

BV Brakes:

- BV brakes must be mechanically fitted and properly adjusted.
- A BV with tandem rear axles must have both axles braked when parked in a stationary operation or must be able to raise the unbraked rear axle.
- Air brakes are preferred over hydraulic brakes on a BV.
- Users should ensure that at least two-thirds of the BV mass is over the rear axle(s).

BV used on Provincial highways must have:

- A mounted 1.2 metre x 2.1 metre TC-12 FLASHING ARROW BOARD with in-cab remote controls.
- A high back seat and head rest for the operator.
- A competent, trained operator.
- An audio alert which automatically activates when backing up.

For both stationary work areas and mobile work operations, no passengers are allowed in the BV when it is used in traffic control situations, except for special reasons

#### NOTE

For stationary work areas and mobile work operations, no passengers are allowed in the BV when it is used in traffic control situations.

Where BV are used to protect stationary work operations, the driver/operator of the BV must ensure that the BV is positioned in accordance with the layout figures in Book 7 and proceed as follows:

1. Ensure that the TC-12 FLASHING ARROW BOARD is operating.
2. Lock the brakes and angle the wheels slightly away from the work area and live traffic.
3. Leave the BV for the duration of the work operation.

### 4.5.1.2 Placement of Buffer Vehicles Using Longitudinal and Lateral Intrusions

To mitigate risk of injury to highway users and workers, two types of out of control vehicular behaviour need to be considered in the placement of BV:

1. Longitudinal intrusions.
2. Lateral intrusions into a work area.

These are further described below.

#### Longitudinal Intrusions

A longitudinal intrusion occurs when a vehicle enters a closed lane upstream of a stationary work area through the taper.

The length of the lane closure taper plus the LBA upstream of the BV should provide the driver with sufficient braking distance, as illustrated in [Figure 4.11 Buffer Vehicles and LBA Scenarios](#).

**In stationary work operations the following longitudinal intrusions could occur.**

#### NOTE

The length of the lane closure taper plus the LBA upstream of the BV should provide the driver with sufficient braking distance.

## Example 1:

- The incoming vehicle entering the lane closure taper longitudinally upstream of the work area begins braking in the taper, after running over the barrels or cones at the start of the taper, and comes to a stop within the taper itself.

## Example 2:

- The incoming vehicle entering the lane closure taper longitudinally upstream of the work area does not begin braking until the end of the taper.
- In this example, the LBA should provide sufficient additional braking distance for the vehicle to come to a halt before the end of the LBA.

## Example 3:

- If the driver has still not come to a complete stop by the end of the LBA, the BV provides a third line of defence for workers.

A BV should not be placed at the end of the taper. If an out of control vehicle does not have sufficient distance to slow down prior to impact, a long BV roll-ahead distance may occur resulting in vehicle damage and personal injury.

**NOTE**

A BV should not be placed at the end of the taper.

Provided the LBA is installed upstream of the BV, the expected BV roll-ahead distance is accommodated within the Lateral Intrusion Deterrence Gap (LIDG). (See Lateral Intrusions below.)

LBA and LIDG for various speeds are given in [Table A](#), [Table B](#), and [Table C](#) found in [Section 6](#).

In **mobile work operations**, stationary LBA cannot be used. See [Section 3.5.1](#) for measures for mobile operations.

**Lateral Intrusions**

A lateral intrusion occurs when a vehicle, in a live lane adjacent to the work area, laterally intrudes into the gap in the closed lane between the BV and the work area.

In stationary and mobile work operations, the appropriate distance to use in front (downstream) of the BV is called the Lateral Intrusion Deterrence Gap (LIDG).

The use of LIDG in **stationary work operations** on freeways and non-freeways in combination with the taper, LBA, and BV, is illustrated in [Figure 4.11 Buffer Vehicles and LBA Scenarios](#).

To mitigate the risk of lateral intrusions into stationary work operations:



- The BV is positioned about 2.5 seconds in travel time upstream of workers. (It takes the driver of a vehicle about 2.5 seconds to perceive and react to the gap in front of a BV).

Example:

- A vehicle travelling at 100 km/h covers 70 metres in 2.5 seconds.
- If a BV is positioned 70 metres upstream of the work area, the driver of the vehicle will likely pass by the work area in front of the BV before a decision can be made to turn into the gap.

LIDG for various NPRS are chosen from [Table A](#), [Table B](#), and [Table C](#) found in [Section 6](#).

The use of LIDG in **mobile work operations** on freeways and non-freeways in combination with a BV, is illustrated in [Figure 4.11 Buffer Vehicles and LBA Scenarios](#).

To mitigate the risk of lateral intrusions into mobile work operations:

- The BV shadows the work vehicle as it moves along the highway at a distance upstream that is equivalent to about 2.5 seconds in relative travel time between the highway user speed and the moving work vehicle.

Example:

- The driver of an errant vehicle will take about 2.5 seconds to perceive and react to the gap in front of a moving BV.
- A vehicle that is travelling at 100 km/h covers 70 metres in 2.5 seconds.
- A BV that is shadowing a moving work operation typically travels at 20 km/h.
- In 2.5 seconds, the BV would cover 14 metres at 20 km/h.
- If a BV is positioned about 56 metres (i.e., 70 metres minus 14 metres) upstream of the work area, the driver of the vehicle will likely pass by the moving work vehicle in front of the BV before a decision can be made to turn into the gap

The appropriate distance to use in front of BV that are shadowing moving work vehicles is the LIDG. LIDG for various NPRS are chosen from [Table A](#), [Table B](#), and [Table C](#) found in [Section 6](#).

#### NOTE

The appropriate distance to use in front of BV that are shadowing moving work vehicles is the LIDG.

Figure 4.11 Buffer Vehicles and LBA Scenarios

### Stationary Operations – No BV (Non Freeways)

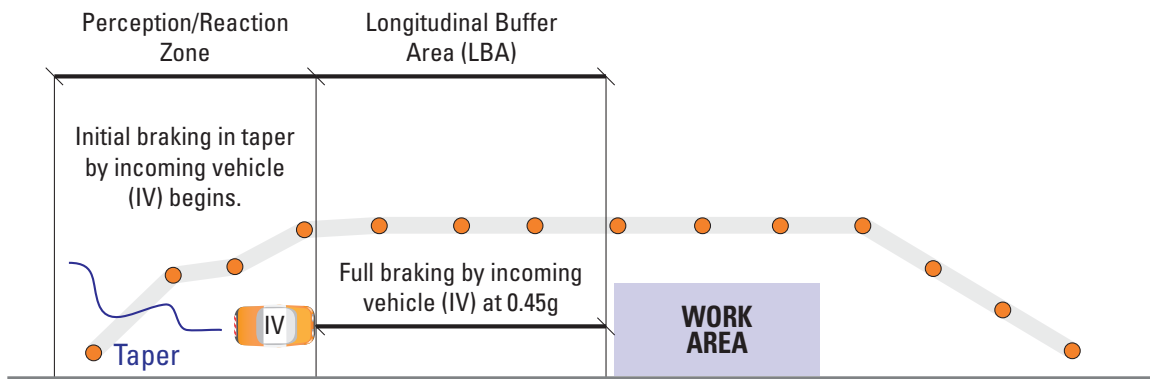

### Stationary Operations – with a BV (Freeways and Non Freeways)

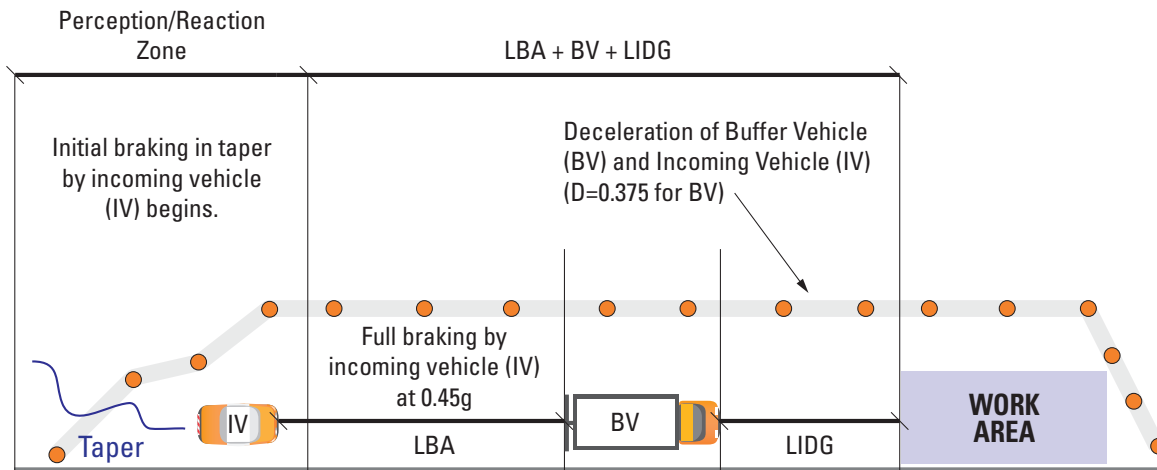

### Mobile Operations – with a BV (Freeways and Non Freeways)

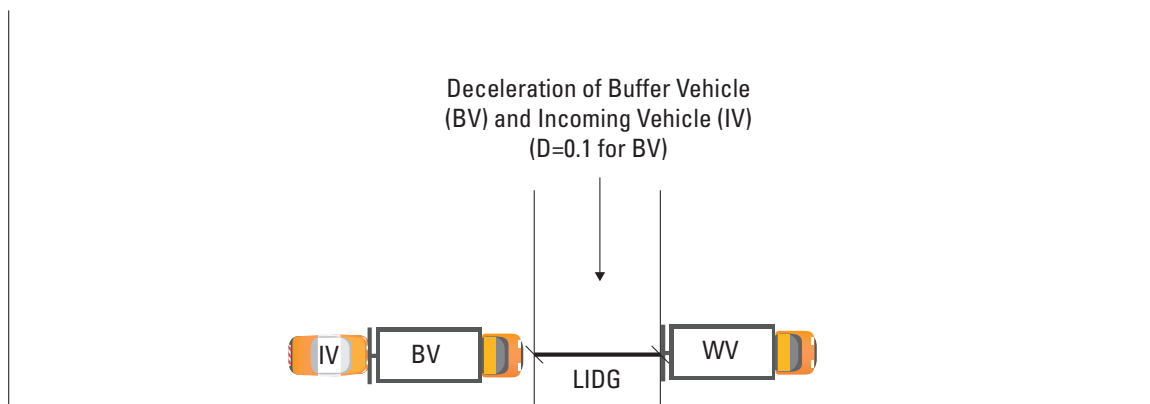

### 4.5.1.3 Lighting Standards on Buffer Vehicles and Work Vehicles

To enhance visibility of BV and work vehicles, lightings are installed on vehicles to support field operations. Especially during situations with limited visibility, such as storm events and nighttime, appropriate vehicle lightings help to mitigate traffic hazards to workers and drivers on public highways. Vehicles that require lightings to function as a traffic control device are typically equipped with either four-way flashers (4WF) plus 360-degree beacon, rotating LED amber lights, or TC-12.

A 360-degree beacon is a device with an amber light source that continually shows the light source through all 360 degrees of the compass, completing a full rotation every 1.5 seconds. If a 360-degree beacon is used, the four-way flashers are not required to be operated continuously for longer duration work.

Alternatively, rotating LED amber lights can be used in place of 4WF plus 360-degree beacon. The rotating LED amber lights must be positioned as a pair; one on the left and the other on the right, mounted and installed at a height so visible from 360 degrees around. Listed below are the specifications required of rotating LED amber lights:

- a) SAE J845 Compliant. SAE J845 provides design guidelines, test procedure references, and performance requirements of optical warning devices for authorized emergency, maintenance, and service vehicles.
- b) Cover can be either amber or clear.
- c) Rotational light pattern in 0.8 to 1.2 Hz range (no strobes or flashes) and both lights shall be in sync with each other having the identical pattern.
- d) Full 360-degree LED light output and must not be able to do any other pattern.
- e) Output of 2500-3000 lumens in non-dimmed state
- f) Auto-dim at night or have switch in cab to enable dim function
- g) "ON/OFF" switch in cab shall be lighted when Rotating LED Amber Lights are in operation

### 4.5.2 Glare Screens

Glare screens are mounted on the top of barriers to minimize distraction to highway users. Their ability to discourage driver distraction and reduce headlight glare from opposing traffic may improve safety and traffic flow.

Screens should not be placed where they may interfere with the safe operation of vehicles, in particular, where they may adversely affect highway user visibility and sight distance.

### 4.5.3 Barriers

Barriers protect work zones and drivers by preventing or reducing penetration to the work zone, and through controlled redirection of an errant vehicle.

When a temporary construction barrier system (TCBS) is specified adjacent to an excavation, a level area extending at least one metre from the upper edge of each wall of an excavation shall be kept clear of equipment, excavated soil, rock and construction material (per *Regulation 213/91, Section 233(1)* of Part III under the OHSA).

The effectiveness of a barrier system depends on:

- Correct placement.
- Size, speed, and angle of the approach of an errant vehicle.

Barriers are required to protect workers from traffic in an adjacent live lane under the following conditions (per *Regulation 213/91, Section 67(1)*, under the OHSA):

- Construction projects on freeways.
- Non-mobile operations.
- On projects that require more than five days to complete, although there may be circumstances that suggest the use of barriers for a period of less than five days to ensure the protection and safety of highway users and workers.

Where all of these conditions are present, but it is not practical to install the barriers as required, or where the project requires five days or less to complete, an LBA and a CT must be adequately positioned to protect workers who are working on a freeway.

In addition, barriers may be required or used to:

- Protect workers when completing maintenance work. (Refer to Regulation 851/90, Section 20, under the OSHA).
- Positively separate two-way, high-speed/high-volume traffic flows.

There are four types of TCBS that have been used successfully on provincial highway projects:

- Temporary Concrete Barrier.
- Moveable Temporary Concrete Barrier.
- Temporary Steel Barrier.
- Temporary Type M Steel Beam Guide Rail.

A description of some of the barrier systems used in Ontario work zones, guidelines, and specifications for their use are provided below.

### 4.5.3.1 Temporary Concrete Barriers

A temporary concrete barrier is a portable barrier system consisting of freestanding precast concrete segments that are positively connected to form a continuous barrier.

Where temporary concrete barriers are used, the following guidelines and specifications apply:

- Temporary concrete barriers must not be placed perpendicular to the direction of travel and are not intended to be used across a highway for a highway closure.
- On long-term freeway construction projects, temporary concrete barriers or other equivalent barrier systems should be installed to protect workers from vehicular traffic in accordance with *Regulation 213/91, Section 67*, under the OHSA.
- Temporary concrete barriers may also be used to positively separate two-way, high-speed/high-volume traffic flows.
- Temporary concrete barriers shall be according to Ontario Provincial Standard (OPS) or other standard when specified by a road authority. Factors to consider include:
  - Temporary concrete barriers shall only be used on a solid surface, such as asphalt or concrete pavement.
  - Temporary concrete barriers are not to be placed such that there are hazards within the deflection area.
  - Temporary concrete barriers can be laterally displaced when struck. Temporary concrete barrier restraint systems or reduced deflection temporary concrete barrier systems should be used on high speed highways when temporary concrete barrier protection is required within:
    - 1.0 metre of an excavation.
    - 1.0 metre of structures not designed for impacts (e.g., scaffolding).
    - 1.0 metre of the edge of a bridge deck.
- Lane closures are required to place a barrier. Barriers should be constructed in the downstream direction.
- An offset distance of at least 0.5 metres from the edge of a lane to the barrier is desirable.
- Temporary concrete barriers and energy attenuators should be offset and installed according to OPS or as specified by the road authority.
- Temporary concrete barriers can impact highway drainage. Winter sand and other debris can block drainage openings under the temporary concrete barrier. Temporary concrete

barrier drainage gaps should only be used when justified based on hydraulic analysis at key drainage locations (sumps, catch basins, etc.).

- Although barrier walls may serve the additional function of channelizing traffic, their use should be determined by the protective requirements of the location rather than the channelizing needs.
- The angle of barrier installation is to deflect an errant vehicle, and not to be confused with the taper length and angle specified in [Table A](#), [Table B](#), or [Table C](#) found in [Section 6](#) that are used for channelization.
- If a protective barrier also functions as the means for channelization, the devices must be used with temporary pavement edge lines as well as reflective delineation.
- Taper lengths must comply with the minimum desirable taper length for various approach speeds as provided in [Table A](#), [Table B](#), or [Table C](#) found in [Section 6](#). Where minimum taper lengths are not practicable within the proper design of the barrier, the required taper must be delineated with TC-54.

#### 4.5.3.2 Moveable Temporary Concrete Barriers

A moveable barrier consists of one metre long sections of linked barriers that can be mechanically shifted laterally, through the use of a special purpose vehicle. A moveable barrier is typically used:

- To provide a reversible lane.
- When the risk associated with frequent lane closures required to accommodate construction staging warrants the expense of a moveable barrier.

#### NOTE

The application of moveable barriers must be approved by the road authority.

The application of moveable barriers must be approved by the road authority.

#### 4.5.3.3 Temporary Steel Barriers (TSB)

TSB are portable barrier systems consisting of free-standing fabricated double-sided steel barrier segments that are positively connected together to form a continuous barrier system. TSB system can be configured to minimize deflection using additional steel anchors at specified intervals. TSB include the following systems:

- BarrierGuard 800 consists of galvanized steel segments meeting the NCHRP Report 350 TL-3. Adjacent segments are connected using connectors that lock into place.
- ZoneGuard meets MASH TL-3. Adjacent segments are connected into place at the top of the barrier.
- The Defender meets MASH TL-3. Adjacent segments are connected using sliding interlocking connectors and a joining pin.

- The Safezone system meets MASH TL-3. Adjacent segments are connected using connectors that lock into place and are secured with a bolt.
- The HV2 system meets MASH TL-4 and does not require anchoring. Adjacent segments are connected using an interlocking joiner.

#### 4.5.3.4 Temporary Type M Steel Beam Guide Rail (Type M SBGR)

Temporary Type M SBGR systems are used for temporary installations on granular roadway surfaces to provide positive protection between traffic and the work area and workers.

### 4.5.4 Ballast Filled Barriers

Ballast filled barriers are longitudinal barriers of segmented polyethylene plastic shells with a steel framework, which are designed for use with ballast of water or sand. Ballast filled barriers should only be used when approved by the highway authority.

Where ballast filled barriers are used, the following guidelines and specifications apply:

- Ballast filled barriers are relatively easy to install, given their initial low weight in comparison to other longitudinal barriers.
  - Empty sections of a barrier may be placed by hand in areas that may have otherwise become restrictive for the use of heavy lifting equipment.
  - Steel rails are then placed on the barriers to redirect potentially impacted vehicles, and water or sand is used as the ballast to secure the barrier. The purpose of steel rails is to completely avoid vehicle penetration through ballast filled barriers.
  - Barriers must be filled in accordance with manufacture's specifications to be effective.
- When ballast filled barriers are impacted, the deflection may be as great as 2.0 metres to 8.0 metres.
  - The deflection is greater for ballast filled than concrete barriers, mainly due to the lighter weight of ballast versus concrete.
  - For this reason, ballast filled barriers should only be used in urban areas of low speed and for vehicles that weigh 1,800 kilograms or less.

#### NOTE

When used for channelizing in a transition taper, devices should provide a smooth and gradual transition.

#### NOTE

Ballast filled barriers must only be used in urban areas of low speed and for vehicles that weigh 1,800 kg or less.

- In cold weather, sodium chloride or an environmentally friendly antifreeze should be used to prevent freezing of the ballast water inside the barrier.
- Care must be taken upon impact, as the ballast water could pose a potential hazard if the water forms into ice on the surface.
- Environmental regulations and guidelines must be followed for the proper removal and drainage of ballast filled barriers. The disposing of the ballast water when the barrier is removed may require the water to be pumped and transported offsite.

**NOTE**

Environmental regulations and guidelines must be followed for the proper removal and drainage of ballast filled barriers.

### 4.5.5 Energy Attenuators

Energy attenuators on barrier ends are needed to reduce the severity of impacts. Energy attenuators shall be according to OPS or other standards as specified by the road authority.

An energy attenuator is typically used:

- With at least 150 mm of asphalt pavement.
- With no anchor needed.
- On a paved surface.

Reduced exposure energy attenuators are a non-redirective, gating, crash cushion system. They meet the crash test requirements of either MASH TL-2 and TL-3 or the NCHRP Report 350 TL-2 and TL-3.

These attenuator systems should be considered for shorter term temporary energy attenuator installations and not to be used during winter shutdown. They include the followings: the Absorb 350, the ABSORB-M, the SLED, and the ACZ 350.

### 4.5.6 Mobile Barriers

Mobile Barrier systems consist of a modular unit on wheels pulled by a standard truck tractor with reversible axles which allow the unit to be reconfigured for either right or left applications. The mobile unit alleviates the need for highway crews to use a TCBS, which reduces the exposure of workers to traffic and the overall duration of work.

Where mobile barriers are used, the following guidelines and specifications apply:

- The mobile unit should be orange in colour to alert drivers that highway work is taking place. For use on freeways, the unit must also be equipped with an approved energy attenuator.



- Typical mobile units can be expanded from 13 metres to 31 metres in length and can be customized by adding:
  - Portable Variable Message Sign (PVMS).
  - Speed detection device.
  - Portable generator.
  - Lighting.
  - Rear wheel steerable axle.
- The determination of whether and where mobile barriers can be used in work zones is at the discretion of the road authority.
- The use of mobile barriers must be approved by the road authority and all necessary permits must be obtained.

**NOTE**

The determination of whether and where mobile barriers can be used is at the discretion of the road authority and all necessary permits must be obtained.

### 4.5.7 Vehicle Arresting Systems

---

Vehicle arresting systems are defined as:

- Portable netting, cables, and energy-absorbing anchors designed to gradually slow down errant vehicles and prevent penetration into activity areas.

Vehicle arresting systems are used to prevent errant vehicles from entering the work space when sections of a highway are frequently opened and closed during extended work operations.

Where vehicle arresting systems are used, the following guidelines and specifications apply:

- The system is placed across the highway at the closure point, downstream ramps, and other potential entrance points.
- Where provisions are necessary to allow construction traffic to bypass the system, the highway authority may elect to have a paid duty officer (PDO) stationed at the bypass to prevent unauthorized entry into the workspace.
- Application and design of vehicle arresting systems must be approved by the highway authority.

### 4.5.8 Temporary Transverse Rumble Strips

---

Temporary Transverse Rumble Strips (TTRS) are grooved or raised corrugations that are placed on the highway pavement surface perpendicular to the path of travel, such that motor vehicles passing over the corrugations simultaneously generate audible and vibratory stimuli.

TTRS are used to alert motorists that they are about to enter a work zone where an unusual or unexpected highway condition exists that requires a speed reduction or stop. For additional information on managing speeds, refer to [Section 3.6](#).

Temporary rumble strips may be used when:

- The work duration is Short Duration or Long Duration;
- Traffic Control Persons are present;
- Portable or Temporary Traffic Signals are used; or
- Drivers are inattentive.

Temporary rumble strips should not be used:

- On a sharp vertical curve.
- On highways shared with cyclists unless there is a clear path of at least 1.2 m in each direction for cyclists to bypass the temporary rumble strips.
- In locations where high volumes of motorcycles are present.
- Where noise may be a concern.

TTRS must not be used:

- On a horizontal curve.
- Within intersections.
- Within pedestrian crossings.

Where TTRS are used, the following guidelines and specifications apply:

- Application and design of TTRS must be approved by the road authority.
- Strips can be glued, screwed or nailed onto the highway surface or can remain in place by weight and friction.
- Strips are typically used in sets of two or three.
- Located at least at the minimum stopping sight distance in advance of the unusual or unexpected highway condition.

## 4.6 Monitoring of Contractor Compliance

The principal responsibility for ensuring that traffic control equipment, materials, and protective devices are maintained in good condition rests with the contractor. Monitoring of contractor compliance by the road authority is also important for quality guidelines to be effective. Quality may decline if monitoring of compliance is not effectively and consistently done.

### NOTE

The principal responsibility for ensuring that traffic control equipment, materials, and protective devices are maintained in good condition rests with the contractor.

## 4.7 Application of New Technologies

New technologies and techniques continue to be developed for application in work zones. As new technologies and techniques are tested in real-life situations, it is important that they be accepted into standard practice and guidelines through an orderly, controlled process.

For this purpose, a public-private partnership was developed by the Ontario Good Roads Association (OGRA) and The Road Authority (TRA). TRA is a web-based database application that provides an information resource on roadway products, services, and technologies used in public works infrastructure, with the municipal and provincial governments.

### NOTE

Initially, new technologies may be accepted only as supplements to existing prescribed traffic control devices.

There are two types of evaluations that can be documented on the TRA website:

1. Pre-qualification of a product or vendor for the Designated Sources for Materials (DSM) list.
2. Product classification through The Ontario Provincial Standards (OPS) Products Management Committee (PMC), which is responsible for the evaluation of products and technologies against applicable standards and specifications.

Further information on the processes for these two scenarios is available from the TRA website and are further described below.

Vendors are encouraged to register their product on TRA for the benefit of all highway authorities.

### **Designated Sources for Materials (DSM)**

The Designated Sources for Materials (DSM) is the Ministry of Transportation's (MTO's) official list of pre-qualified products and vendors for use on provincial highway construction and maintenance

contracts. The DSM acceptance criteria for the product listing may include, but is not limited to:

- Testing in the laboratory.
- Evaluation of a product under field conditions.
- Inspection of the manufacturer’s facilities.

**NOTE**

Vendors are encouraged to register their product on TRA for the benefit of all road authorities.

The DSM listing indicates that the listed manufacturer/distributor is capable of producing a product that meets MTO requirements or has demonstrated the ability to meet them in the past. Products accepted for use on the DSM must meet the general criteria outlined in DSM 100 - General Requirements for Listing Vendors and Products which can be found on the TRA website.

### Product Classification

The OPS PMC is responsible for the evaluation of products and technologies against applicable standards and specifications. TRA publishes the decisions made by the committee.

Products that are designated as, “Accepted for Use” have:

1. Been reviewed by the committee.
2. Met the established criteria.
3. Been recommended as acceptable products for use in Ontario.

Large municipal governments may consider placing these products on their lists of acceptable products, while smaller municipalities may solely rely on the lists published by the MTO, other municipalities, or TRA (The Road Authority, 2019).

Products that are classified as “Under Evaluation”, are undergoing lab testing and field trials and have not been evaluated yet as an accepted product for use (The Road Authority, 2019).

In addition, road authorities may conduct field evaluations of new devices or layouts. Initially, new technologies may be accepted only as supplements to existing prescribed traffic control devices, not as replacements for them.

However, as experience and satisfaction are gained with the new technologies, some of them may be accepted as part of the family of prescribed traffic control devices, while others may continue to be accepted, but only as supplemental devices. Their mandatory use is at the discretion of TRA.

An assessment of the need and evaluation of effectiveness should be conducted and documented where a road authority is considering:

- The trial of a new device.

- A change to an existing device.
- The application of an existing device outside general policy or practice.

For trials on provincial highways, approval is required from the regional Traffic office, and the provincial Traffic office should be consulted on the proposed process and provided with the results of the assessment for potential policy development.

To conduct a field evaluation of a new technology, the following information should be documented in a proposal:

- Detailed description and drawings of the traffic control device/application being proposed.
- Description of the problem that the proposal seeks to overcome.
- Location of the proposed trial and why this site is suitable.
- Time frame involved.
- How the non-standard treatment, or new technology can address the problem better than existing practices.
- Outcomes of any previous trials or investigations.
- Jurisdictional scan of relevant legislation, policies, and/or guidelines.
- Assessment of any new safety issues, or other problems that may result from the new technology.
- Rationale that the proposed trial will be easily understood by road users.
- List of all interested parties and the likely level of up-take.
- Information on consultation undertaken and/or proposed.
- A plan for close monitoring of any field trial, especially in the early stages of implementation.
- Prior to field testing, detail how the performance of the new technology will be assessed including any computer or other technical analysis used.

The results of the field evaluation should show:

- How the proposal affects each class of road user with respect to the desired outcome.
- The level of understanding of the proposed device/application (obtained from road users through observation, interviews, or questionnaires).
- The reliability/performance of the device/application.
- The information collected was well-defined and appropriate.
- A sound scientific design was used with appropriate controls so that any conclusions reached are supported by robust statistical analysis.

## 5

**Set Up and Removal of Temporary Traffic Control**

Section 5 describes best practice procedures for implementing temporary traffic control from preparation before beginning to work, to the setup and removal of traffic control measures/devices.

This section is of importance to any person designing, project managing, or physically providing or setting up traffic control.

The set up or removal of traffic control (e.g., lane closures) on highways involves an additional element of risk for traffic control workers and highway users until all devices are in place.

The principles and procedures set out below have been developed to minimize risks for all workers and highway users. Where competing risks need to be weighed, the safety of workers who are handling traffic control devices on the highway is considered paramount since these workers are the most vulnerable.

**NOTE**

Where competing risks need to be weighed, the safety of the workers who are handling traffic control devices on the highway is considered paramount.

As required by *O.Reg. 213/91* and *O.Reg. 145/00* under the OHSA, all workers, including TCP, responsible for on-site duties such as, installing or removing traffic control devices or measures must be:

1. Competent workers.
2. Aware of the requirements of the OHSA.
3. Trained in the application of OTM Book 7.
4. Capable of receiving written and oral instructions in a language easily understood.
5. Not performing any other work while installing or removing traffic control devices or measures.
6. Not performing any other work while directing vehicular traffic.

Additionally, workers responsible for on-site duties must:

- Not perform other functions while installing or removing traffic control devices (for TCP, see also [Section 4](#)).
- Ensure that enough vehicles (including CT), signs, barriers, barricades, and markers are taken to the work site to provide appropriate protection, and that TCP are available and on-site when required. If night-time protection is required, ensure that the appropriate devices are available.
- Ensure that the vehicles, signs, barricades, and markers are in good and clean conditions and meet the applicable specifications, including minimum reflectivity levels (see [Section 4](#)).
- Cover or remove any conflicting, existing traffic control devices.
- Record that the traffic control devices were installed according to the traffic control plan (or layout), as well as any modifications or deviations from the traffic control plan.

## 5.1 General Requirements

Section 5.1 describes the general requirements for the set up and removal of temporary traffic control devices in a work zone.

Workers who set up, use, or remove (take-down) work zone traffic control should apply the following safety principles. These principles apply to both non-freeways and freeways.

### Set-up of work zone traffic control

The following safety principles should be applied when **setting up traffic control in a work zone**

1. Position work vehicles upstream of the work area rather than downstream so that flashing lights and/or flashing arrows indicate a visual presence and obstacle to drivers.
2. Assemble and disassemble traffic control devices away from the highway. Where feasible, drop off traffic barrels along the shoulders adjacent to the lane closure in advance.
3. AFADs, PLCS and PTTS should as much as possible, be partially or fully setup up and tested with any required settings or timings prior to being moved into position on the highway to minimize disruption to traffic. When moving any of these devices into position on the highway, the signalling displays should be turned off to reduce driver confusion.
4. Set up work zone traffic control devices starting at the upstream end of the work zone and proceeding downstream.
5. When installing a continuous line of channelizing devices, always place the channelizing devices in sequential order from the upstream end
6. Reduce barrel spacing on the inside curves, on hills, in the immediate vicinity of ramps and the work area, and in the taper, if considered needed to reinforce the closure.
7. Cones may be used for SD daytime work only (barrels are preferred)
8. Maintain an offset of 0.3 metres to 0.6 metres between the flexible drums (barrels) and the edge of the travelled lane, if possible.
9. When placing a traffic control device, ensure that it is not obscured by other objects.
10. Where there are multiple lanes in one direction, and staggered signage is required on both the left and right shoulders, first place the signs on the opposite shoulder from the lane that is being closed, then place the signs on the same shoulder as the closed lane.
11. Drive through the work zone on all approaches to ensure worker and public safety and to ensure all devices are installed and functioning as intended.

#### NOTE

Set up work zone traffic control devices starting at the upstream end of the work zone and proceeding downstream.

12. Cover, turn or remove signs and devices when they are not required. Remove the cover immediately before work at the work site begins.
13. Ensure the layout is implemented as approved, record this information, and keep a copy available on site as part of the Traffic Control Plan and/or the Traffic Protection Plan.
14. Ensure any operational adjustments to the layout are recorded with reasoning, date, and time.
15. Approval may be required.

### Removal of work zone traffic control

The following safety principles should be applied when **removing traffic control in a work zone**:

1. Drive through the work zone before removal of traffic control devices to ensure that all workers are off the road, and that there are no gaps in the closure.
2. Remove traffic control devices in the opposite order from which they were installed, starting with the closed lane(s), i.e., the last barrel (or cone) installed is the first barrel removed.
3. Advance signs are an exception. Remove advanced signs on the left and right shoulders in a downstream direction, in the same order they were installed. Removal of advanced signs must not be done until all other traffic control devices are removed.
4. Do not face work vehicles upstream when removing lane closures except in unusual circumstances. Never face work vehicles upstream at night.

#### NOTE

Removal of advance signs must not take place until all other devices are removed.

## 5.2 Freeway-Specific Requirements

The following additional safety principles should be applied specifically **for traffic control on a freeway**:

1. Use a CT to protect workers who are installing or removing lane closures (except when 3.0 metres or more from a live lane or when installing or removing advance signage on shoulders wide enough to park on). Refer to [Section 4](#) for more information on CT and their implementation.
2. Position and maintain the CT at an LIDG distance (see [Table C](#)) upstream of workers when lane closures are being installed or removed.
3. Install and remove freeway lane closures as quickly as possible, particularly the tapers.
4. Back up the CT and work vehicles during removal of lane closures to provide protection for downstream workers. Do not back CT and work vehicles into a live lane of traffic.



## 5.2.1 Set up of Freeway Lane Closures

The set up and removal of freeway lane closures are operations that require special consideration. The best practices outlined in this section must be used for provincial freeway lane closure, set ups and removals. The same procedures can be used on non-freeways, with or without a CT.

Road authorities may approve the use of alternative procedures or modifications of the procedures listed below to suit certain situations.

### NOTE

The ministry and other road authorities may approve the use of alternative procedures to suit certain situations.

### 5.2.1.1 Freeway Closure of Single Right or Left Lane (with Shoulders)

The procedure described below is for a single right lane closure on a freeway with a full shoulder on the right side. The same approach, with appropriate modifications, is to be used for a single left lane closure on a freeway with a full shoulder. Where feasible, a rolling closure should be used as the alternative.

#### A. Preparation (Figure 5.1, Step A).

1. Install signage on the shoulders in the advance warning and approach areas, as outlined in the Traffic Control Plan.
2. Use a CT and a Sign Truck (ST), with installers, that is pulling one TC-12 arrow board trailer.
3. Position the CT on the right shoulder, approximately 1 km to 2 km upstream of the beginning of the taper.
4. Position the ST, with installers, and a detachable TC-12 arrow board trailer in the left arrow mode on the shoulder at the beginning of the lane closure taper.

#### B. CT Enters the Roadway (Figure 5.1, Step B)

1. When directed by the installers, the CT enters the traffic stream in the right lane with its flashing TC-12 arrow board in the left arrow mode and proceeds downstream. The CT gradually reduces its speed while monitoring upstream traffic to ensure that it is responding to the TC-12 flashing left arrow board.

#### C. Installing the Taper (Figure 5.1, Step C)

1. When the CT is at an LIDG distance (see [Table C](#)) from the start of the taper, the installers begin to retrieve barrels from the shoulder or vehicle, and sequentially place them at

appropriate intervals specified in [Table C Work Zone Component Dimensions: Freeways](#) to form the taper. The installers move forward and install the barrels ahead of the sign truck.

2. The CT shadows the ST at an LIDG distance in line with the position of the installers.

**D. Completing the Taper and LBA (Figure 5.1, Step D)**

1. When the open lane width outside the taper becomes too narrow for the CT not to encroach into the adjacent lane, the CT drives through the barrels and continues to shadow the ST at an LIDG distance, moving parallel to the taper.
2. As the last barrel of the taper is installed, the ST detaches its TC-12 arrow board trailer at the end of the taper and positions it in the lane being closed in left arrow mode, ensuring 4WF/360° is activated. Room is provided to ensure that the CT can pass the arrow board trailer on the right.
3. The installers then begin to install the barrels for the LBA downstream of the ST. The CT moves downstream, maintaining a separation distance of LIDG to the ST.
4. When the CT reaches the TC-12 arrow board trailer at the end of the taper, the CT drives around the trailer on the right and repositions itself at an LIDG distance from the ST in the lane being closed.
5. The remaining barrels for the longitudinal buffer, work, and termination areas are installed in a downstream direction with the CT following the ST at an LIDG distance.

**Figure 5.1 Freeway Closure of Single Right or Left Lane (with Shoulders)**

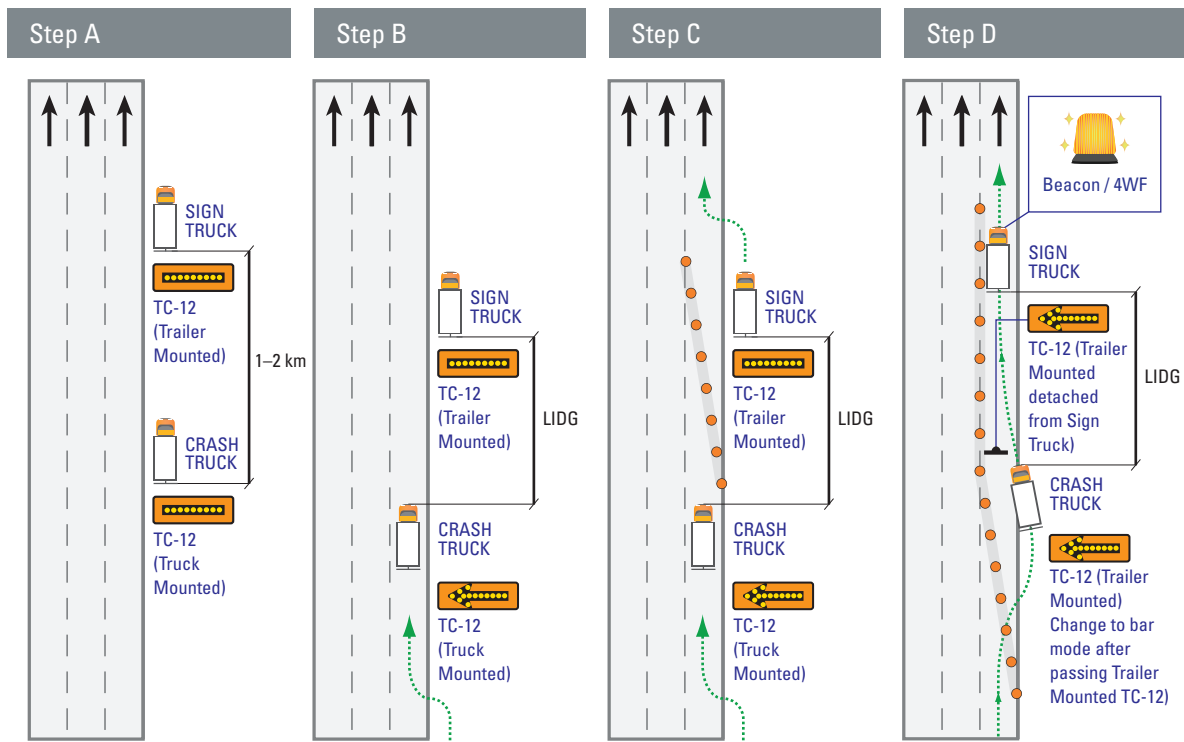

### 5.2.1.2 Freeway Closure of Two Right or Left Lanes (with Shoulders)

The procedure described below is for a two right lane closure of a freeway with full shoulders on the right. A similar approach with appropriate modifications is to be used for a two left lane closure with shoulders. Where feasible, a rolling closure should be used as the alternative.

#### A. Preparation (Figure 5.2, Step A)

1. A CT and a ST, with installers, that is pulling a TC-12 arrow board trailer is to be used along with a TC-12 trailer pre-positioned on the right shoulder or towed in tandem on the right shoulder, at the downstream end of the first taper.

#### B. First Taper and Tangent (Figure 5.2, Step B)

1. The procedure detailed in Section 5.2.1.1 for a single right lane closure is used to install the first taper in the right-most (outer) lane.
2. When the end of the right-most lane taper is reached, the TC-12 arrow board pre-positioned on the shoulder is brought over from the shoulder and positioned in the centre of the lane at the end of the taper in the left arrow mode.
3. The installers then begin to install the barrels for the tangent or parallel section. The CT shadows the ST at an LIDG distance.
4. When the CT reaches the TC-12 arrow board at the end of the first taper, the CT drives around the TC-12 on the right and repositions itself at an LIDG distance from the ST in the lane that is being closed.

#### C. Second Taper (Figure 5.2, Step C)

1. The remaining barrels for the parallel section are installed in a downstream direction with the CT following the ST at an LIDG distance.
  - A TC-3R is installed in the parallel section.
  - A TC-4L is installed at the start of the second taper.
  - The CT drives around the TC-3R and TC-4L on the right.
2. When the parallel section has been installed, the installers place the barrels for the second taper.
  - The CT shadows the ST at an LIDG distance.
  - When the end of the second taper is reached, the ST detaches its trailer-mounted TC-12 and leaves it in the left arrow mode.
3. After detaching the TC-12, the sign truck must ensure its 4WF/360° are activated.

**D. Second LBA (Figure 5.2, Step D)**

1. The installers then begin to place the barrels for the LBA.
  - The CT shadows the ST at an LIDG distance.
  - When the CT reaches the TC-12 arrow board trailer at the end of the second taper, the CT drives around the trailer on the right, and repositions itself at an LIDG distance from the ST.
2. The remaining barrels for the longitudinal buffer, work, and termination areas are installed in a downstream direction with the CT following the ST at an LIDG distance.

**Figure 5.2 Freeway Closure of Two Right or Left Lanes (with Shoulders)**

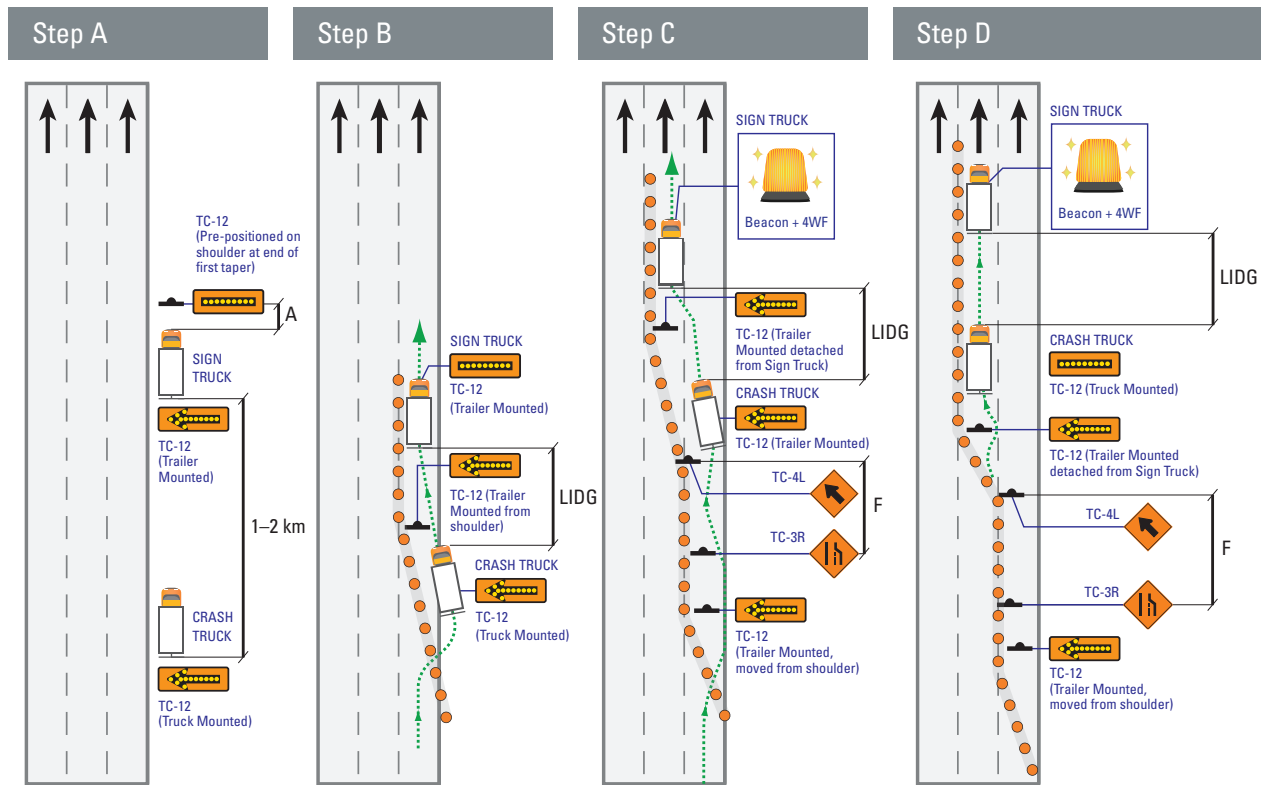

Left lane closure is mirror image of right lane closure.

\*See [Figure 5.3](#) and [Table D](#).

**5.2.1.3 Freeway Closure of One or Two Right or Left Lanes (No Shoulder on Roadway Side where Lanes are being Closed)**

This procedure describes a freeway closure for:

- Two left lanes where the left shoulder is too narrow to permit a CT to use that shoulder to drive around a TC-12 sign trailer positioned in the adjacent lane.

- Two right lanes where the right shoulder is too narrow to permit a CT to use that shoulder to drive around a TC-12 sign trailer positioned in the adjacent lane.

If only the left-most or right-most lane is to be closed, and there is a narrow or minimal shoulder, the procedures used are the same, although the steps related to the closure of the second lane are omitted and only one CT is required.

#### A. Preparation (Figure 5.3, Step A)

1. Install signage on the shoulders in the advance warning and approach areas as outlined in the Traffic Control Plan. A CT is not required if it will take less than 30 minutes and there is no encroachment into the adjacent traffic lane. Signage is installed either on both sides of the freeway if space permits, or on the right side of the highway by using double signage.
2. If the ST that is installing advance signage must encroach into the adjacent live lane, a CT must be used to protect the ST, located at an LIDG distance upstream of the ST.
3. A convoy of lane closure work vehicles is positioned on the right shoulder or an on-ramp, approximately 1 km to 2 km upstream of the beginning (upstream end) of the taper.
4. Starting at the upstream end, the convoy consists of:
  - CT#1 and CT#2.
  - A ST with a TC-12 arrow board trailer and installers.
  - A Work Truck (WT) loaded with barrels. The WT is needed as the barrels cannot be placed on the left shoulder in advance of the lane closure operation as there is no shoulder, and not all the barrels required can be carried in the ST.

#### B. Positioning the Convoy (Figure 5.3, Step B)

1. The convoy enters the traffic stream from the right side.
2. The convoy gradually changes lanes until it enters the left-most lane.
  - The TC-12 on the ST trailer, CT#1, and CT#2, are in flashing bar mode until they enter the left-most lane, at which time the CT operators use their in-cab switches to change their TC-12 to the right arrow mode.
  - The WT operates with the 4WF/360° activated. The convoy slowly decreases in speed.
3. CT#1 and CT#2 monitor upstream traffic to ensure that it is responding to the flashing right arrow. If the traffic is responding, the convoy slows to a stop such that:
  - CT#2 is positioned at an LIDG distance upstream of the start of the taper.
  - CT#1 stays at an LIDG distance upstream of CT#2.

**C. First Taper and Tangent (Figure 5.3, Step C)**

1. The ST and WT are positioned downstream of the start of the taper. The installers remove barrels from the ST and quickly install them for the first taper at the appropriate spacing provided in [Table C Work Zone Component Dimensions: Freeways](#).
2. CT#1 and CT#2 move forward as the installers move forward. CT#2 maintains an LIDG distance upstream of the installers. CT#1 stays an LIDG distance upstream of CT#2.
3. CT#2 moves through the taper when the lane width outside the taper becomes too narrow for the CT not to encroach into the adjacent lane and maintains an LIDG distance upstream of the installers as they continue to install the barrels and close the lane over a distance of 300 metres (see [Table C](#)).
4. CT#1 follows CT#2 through the taper when the lane width outside the taper becomes too narrow for the CT not to encroach into the adjacent lane.
5. The whole convoy moves ahead and approaches the end of the first taper.

**D. Second Taper (Figure 5.3, Step D)**

1. When CT#1 reaches the end of the taper, it parks at an LBA distance from the end of the taper with its TC-12 in the right arrow mode. The CT#1 driver/operator leaves CT#1 on the left and joins the installers.
2. The barrels in the tangent or parallel section are then installed in a downstream direction with CT#2 following the installers at an LIDG distance.
3. A TC-3 is installed in the parallel section as far to the right as possible. When CT#2 reaches TC-3, it passes TC-3 on the left.
4. Once the parallel section has been installed, placement of the barrels for the second taper in the second lane begins.
  - TC-4 is installed at the start of the second taper.
  - CT#2 drives around TC-4 on the left and moves forward, parallel to the taper, maintaining an LIDG distance to the ST.
  - When the end of the second taper is reached, the ST detaches its TC-12 trailer and installs it in the second lane in the right arrow mode.
5. The ST then pulls into the left-most lane and moves downstream, leaving the installation area.
6. CT#2 pulls to the left around the TC-12 arrow board trailer at the end of the second taper and back into the second lane that is being closed.

**E. Second LBA (Figure 5.3, Step E)**

1. CT#2 maintains an LIDG distance to the installers.

- The installers take barrels from the WT and place them to install the longitudinal buffer, work, and termination areas.

**Figure 5.3 Freeway Closure of Two Right or Left Lanes (No Shoulder on Roadway Side where Lanes are being Closed)**

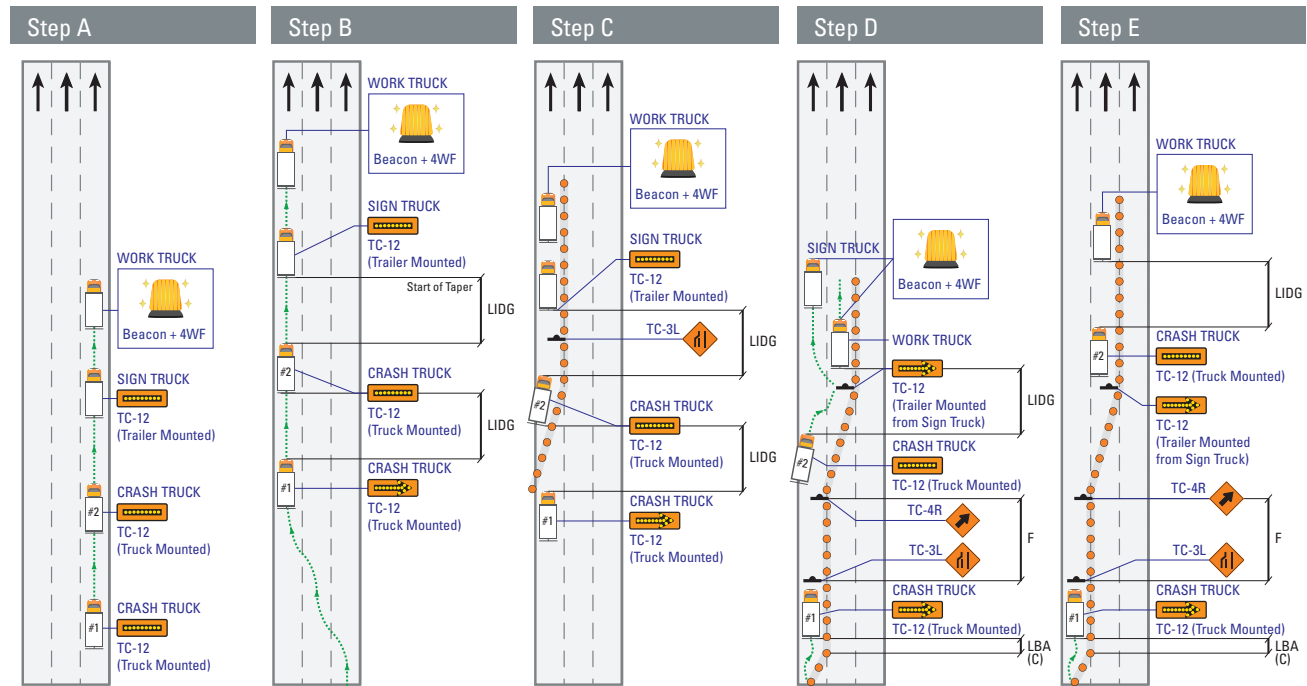

Right lane closure(s) is essentially mirror image of left lane closure(s).

**NOTE**

**Figure 5.3:**  
 On a freeway, drivers may not expect the high speed left (median) lane to be closed. To avoid confusing drivers during extended long duration left lane closures, the road authority may require the contractor to close the right-most lane(s) first, shift the traffic to the left lane(s), then re-open the right lane and close the left lane.

\*See [Table C](#) and [Table D](#).

## 5.2.2 Removal (Take-down) of Freeway Lane Closures

### 5.2.2.1 Removal of Single Right or Left Lane Closure (Freeway with Shoulders)

The procedure described below is for the removal of a single right lane closure. A similar approach (with necessary and appropriate modifications) is to be used for the removal of a single left lane closure with shoulders.

**A. Preparation (Figure 5.4, Step A)**

1. The ST and barrel installers (now removers) are positioned at the downstream end of the termination area, at the last barrel installed. The CT is located at an LIDG distance upstream of the ST. The removers work downstream of the ST.
2. The traffic barrels are removed in the reverse direction in which they were installed, so that the last barrel installed is the first removed. The barrels are set on the shoulder for later re-use or retrieval.
3. The ST and CT slowly back up through the termination area, work area, and LBA as the barrels are removed, maintaining the same relative spacing and positioning throughout.

**B. Removing the Taper (Figure 5.4, Step B)**

1. When the CT comes to the TC-12 trailer at the downstream end of the lane closure taper, it backs around the TC-12 on the right side and positions itself at an LIDG distance upstream of the TC-12.
2. When the lane closure removers come to the TC-12, they place it on the shoulder for later retrieval.
3. The CT then backs up parallel to the taper barrels on the downstream side of the barrels. The CT maintains an LIDG distance to the ST as the barrels are quickly moved to the shoulder by the removers.

**C. Leaving the Construction Site (Figure 5.4, Step C)**

1. When the CT reaches the last barrel in the taper, it will be on the shoulder of the highway. The last barrels are quickly moved to the shoulder as the CT backs up on the shoulder while maintaining an LIDG distance to the removers.
2. The ST and CT then proceed downstream to the next interchange.
  - The ST circles around, drives downstream on the right shoulder and removes the signs in the order in which they were installed in the advance warning and approach areas by using a VSD operation.
  - The ST then circles around and removes any advance signs on the left side of the highway in a similar manner.
3. Depending on the duration of the project, the barrels on the right shoulder may either be removed or left there for re-installation.

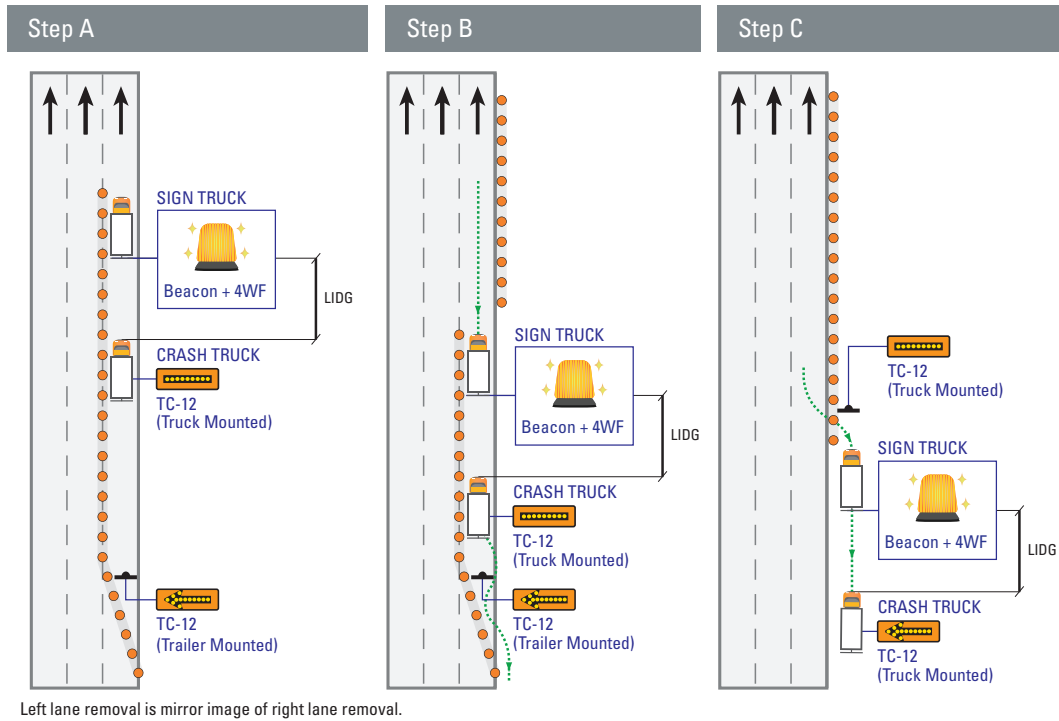

**Figure 5.4 Removal of Single Right or Left Lane Closure (Freeway with Shoulders)**

\*See [Table D](#).

### 5.2.2.2 Removal of Two Right or Two Left Lane Closure (Freeway with Shoulders)

The procedure described below is for the removal of a two right lane closure with shoulders. A similar approach (with necessary and appropriate modifications) is to be used for the removal of a two left lane closure with shoulders.

#### A. Removing the Second Lane Tangent (Figure 5.5, Step A)

1. The ST and the lane closure installers (now removers) are positioned in the right lane at the downstream end of the termination area, at the last barrel installed. The CT is in the second lane upstream of the ST at an LIDG distance.
2. The barrels are removed in the reverse direction in which they were installed, so that the last barrel installed is the first removed. The barrels are set on the shoulder for later re-use or retrieval.
3. The ST and CT slowly back up through the termination area, work area, and LBA as the barrels are removed. The CT maintains an LIDG distance upstream of the ST.

#### B. Removing the Second Lane Taper (Figure 5.5, Step B)

1. The CT backs up until it comes to the TC-12 trailer at the downstream end of the centre lane closure taper.

2. The CT backs around the TC-12 on the right side and positions itself at an LIDG distance upstream of the TC-12 in the centre lane taper. When the removers come to the TC-12, they place it on the shoulder for later retrieval.
3. The CT backs up parallel to the taper barrels on the downstream side of the barrels. The CT maintains an LIDG distance to the ST. The removers work in front of the ST as the taper barrels are moved to the shoulder.
4. When the CT reaches the last barrel in the centre lane taper, it backs down the parallel section with the ST at an LIDG distance downstream of the CT.
5. The removers continue to remove the barrels and as they approach them, the TC-4 and TC-3 signs are also taken away.

**C. Removing the Right Lane Tangent and Taper (Figure 5.5, Step C and Step D)**

1. The rest of the lane closure removal is the same as the removal of a single right lane closure (see Section 5.2.2.1).

**Figure 5.5 Removal of Two Right or Two Left Lane Closure (Freeway with Shoulders)**

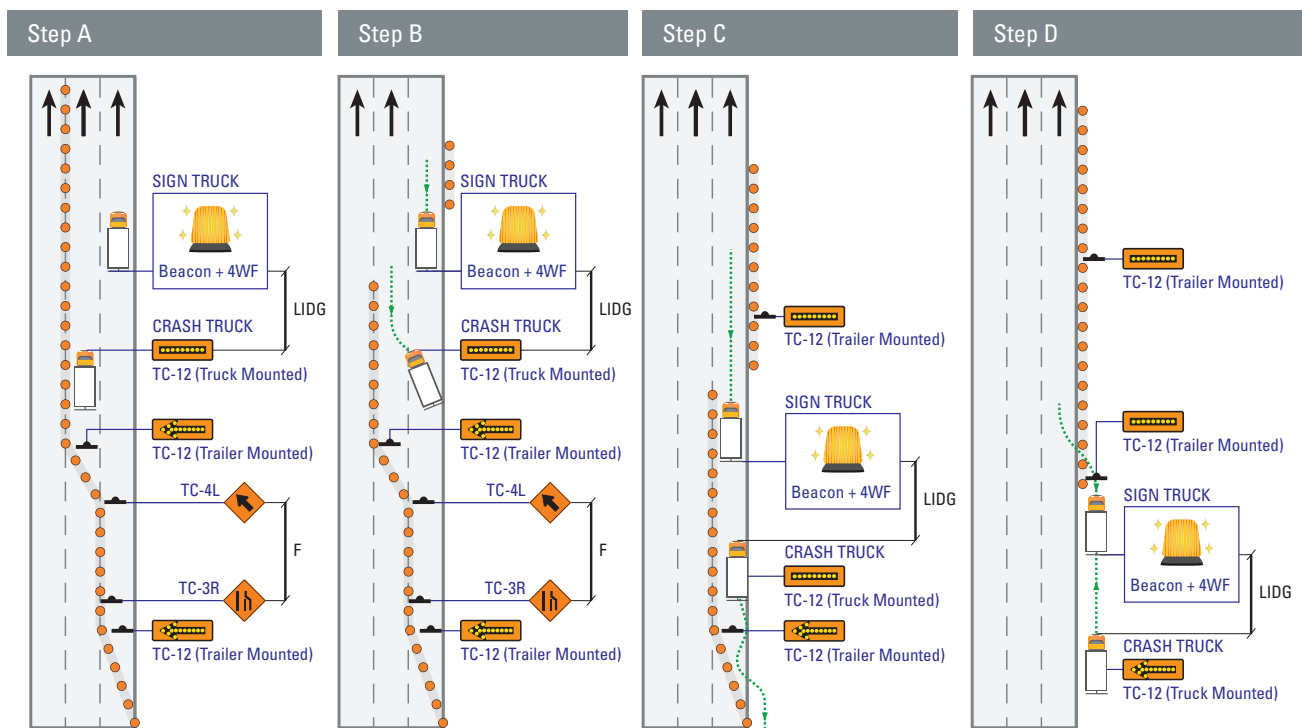

Left lane(s) removal is essentially mirror image of right lane(s) removal.

\*See [Figure 5.3](#) and [Table D](#).

### 5.2.2.3 Removal of Two Right or Two Left Lane Freeway Closure (No Shoulder on Roadway Side where Lanes are being Closed)

This procedure describes the removal of a freeway closure of two left lanes where there is no shoulder or a minimal shoulder on the left side of the highway and is similar to the removal of a freeway closure of two right lanes with no or minimal right shoulder.

If only the left lane has been closed, the procedure is essentially the same, except that the steps related to the removal of the closure of the second lane are omitted.

#### A. Preparation (Figure 5.6, Step A)

1. The lane closure installers (now removers) and the WT are in the second lane at the downstream end of the termination area.
2. CT#2 is in the second lane at an LIDG distance upstream of the WT with its arrow board sign in arrow mode.
3. A ST is in the left-most lane beside CT#2.
4. All three vehicles back up through the lane closure, maintaining the same spacing and positioning throughout, as the barrels are removed in the reverse order in which they were installed and are placed in the WT.

#### B. Removal of TC-12, Second Lane Tangent and Second Lane Taper (Figure 5.6, Step B)

1. When CT#2 reaches TC-12 at the downstream end of the second lane taper, it backs around TC-12 on the left side and positions itself at an LIDG distance upstream of TC-12 in the taper with its arrow board in the right flashing mode.
2. The ST hooks up the TC-12 trailer and tows it out of the closure to a storage area with the arrow board collapsed and switched off.
3. The lane taper barrels are removed and placed in the WT.
4. CT#2 backs up parallel to the taper as the barrels are removed, maintaining an LIDG distance upstream of the WT.
5. CT#2 backs around TC-4 into the parallel section with its TC-12 arrow board in the right arrow mode. The removers remove TC-4 and work upstream, removing the parallel section barrels.

#### C. Removal of Left Lane Tangent (Figure 5.6, Step C)

1. As the parallel section barrels are removed, CT#2 backs up in the parallel section and around TC-3.
2. The removers remove TC-3 and work upstream, removing the parallel section barrels, until they reach CT#1 at the downstream end of the first taper.

**D. Removal of Left Lane Tangent and Taper (Figure 5.6, Step D)**

1. CT#2 and the WT leave the work area, turn around at the next interchange and circle back to the upstream end of the first taper. CT#2 slows to a stop in the left-most lane at an LIDG distance upstream of the start of the taper.
2. The removers exit the WT on the left and quickly remove the barrels in the first taper and load them into the WT.
3. CT#2 moves forward as the WT moves forward, maintaining an LIDG distance upstream of the WT.
4. When the end of the first taper is reached, CT#1, the WT, and CT#2 move off in a convoy.
5. The ST, protected by a CT that is shadowing it at an LIDG distance, picks up any advance signs on the left and right shoulders in a downstream direction.

**Figure 5.6 Removal of Two Right or Two Left Lane Closure (No Shoulder on Roadway Side where Lanes are being Closed)**

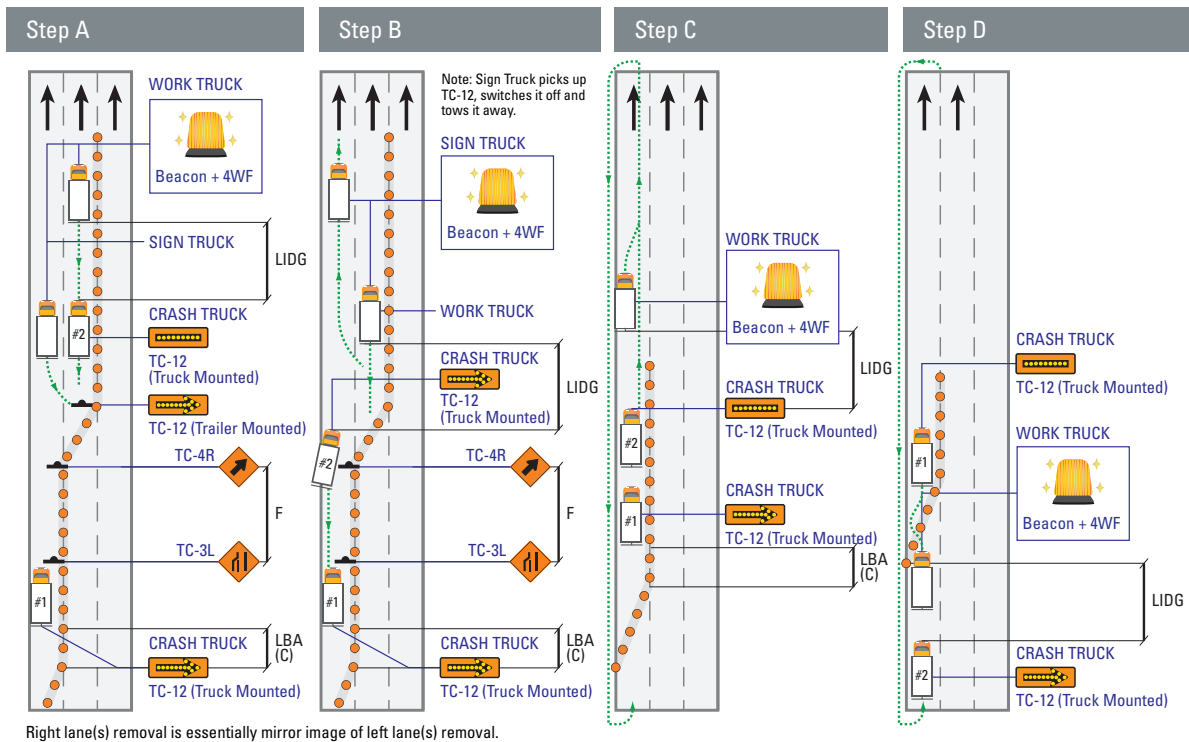

\*See [Figure 5.3](#) and [Table D](#).

**5.2.3 Freeway Zone Painting**

A stationary LBA must not be used for mobile work operations, as it increases the risk of an out-of-control vehicle striking the back of the CT in the longitudinal direction.

To mitigate this risk, contractors and staff who are working for the MTO in zone striping operations on high speed, multi-lane provincial highways must meet the following requirements:

- Use one CT to shadow the zone striper at an LIDG distance (i.e., CT#3 (see [US-12](#), [DS-12](#), or [FS-5](#))).
- Add two additional CT upstream of CT#3 (i.e., CT#1 and CT#2).
- CT#2 shadows CT#3 at a distance of 100 metres to 300 metres.
- CT#1 shadows CT#2 at a distance of 300 metres to 600 metres.

The additional CT are spaced out depending on highway geometrics and the time that it takes for the paint to dry.

In addition, where shoulder conditions and geometrics will permit:

- A pre-warning ST with an overhead beacon shadows CT#1 at a distance of 500 metres to 800 metres on the right shoulder with a sign that reads, “Road Painting – Left (or Right) Lane – 2 km”.
- A pre-warning ST is not required on high traffic volume, urban freeways with physical space limitations (e.g., within the city limits of Toronto or Ottawa).
- It is recognized that zone striping operations on municipal highways do not require the same degree of protection required on multi-lane high speed, provincial freeways.

#### NOTE

It is recognized that zone striping operations on municipal highways do not require the same degree of protection required on multi-lane high speed, provincial freeways.

## 5.2.4 Freeway Paving

The following guidelines apply to paving operations on freeways:

- Construction regulations under the OHSA include paving as a mobile operation and require the use of BV for freeway paving operations. While paving operations progressively move along the highway, they do so very slowly, at only a few kilometres each day.
- In terms of traffic control required, paving operations are similar to SD or LD stationary operations and treated as such in the layouts in Book 7, which fully complies with the traffic control requirements for mobile operations as prescribed in Section 67 (12) of the construction regulations.
- Layouts that are labelled “Mobile Operations” do not apply to paving operations.
- A reduced regulatory speed limit of 80 km/h (black/white) must be used, and enforced by police or pace vehicles, at times when work is being performed. The reduced speed limit signs must be covered when no work is being performed.

#### NOTE

Layouts that are labelled “Mobile Operations” do not apply to paving operations.

- PVMS may be placed on one or both sides of the highway, 500 metres in advance of the work zone, to warn motorists of the reduced speed (supplementing [UG-2](#), [DG-2](#), and [FG-2](#)). PVMS that advise of a lane closure should be positioned upstream of the expected ends of queues.
- To enhance visibility for motorists, the machinery used in paving operations should have conspicuity tape appropriately applied.

**6****Layouts for Signing Temporary Work Zone Situations**

The material in this section is organized as follows:

[Table A Work Zone Component Dimensions: Mobile, Intermittent, and Very Short Duration Work \(Non-freeways\)](#)

[Table B Work Zone Component Dimensions: Short and Long Duration Work \(Non-freeways\)](#)

[Table C Work Zone Component Dimensions: Freeways](#)

[Table D Typical Usage of Signs through a Temporary Work Zone](#)

[Table E Usage of Channelizing Devices, Barricades, and Barriers](#)

[Table F Nomenclature for Layout Decision Matrix](#)

[Table G Decision Matrix: Layouts](#)

[6.1 General Notes to Layouts](#)

[6.2 Legend of Symbols used in the Typical Layouts](#)

[Layouts](#)

**Table A Work Zone Component Dimensions: Mobile, Intermittent, and Very Short Duration Work (Non-freeways)**

Label	Description	Normal Posted Regulatory Speed Limit <sup>2</sup>				
		50 km/h or lower	60 km/h	70 km/h	80 km/h	90 km/h
<b>TCP</b>	Taper Length for TCP Presence (m)	15	20	25	30	30
<b>A <sup>1</sup></b>	Taper Length for Full Lane Closure (m)	60	85	100	100	110
<b>B <sup>1</sup></b>	Shoulder Taper (m) <sup>3</sup>	20	30	35	35	40
<b>C <sup>1</sup></b>	Longitudinal Buffer Area (LBA) (m) <sup>4</sup>	(30)	(40)	50	60	75
<b>D</b>	Maximum Distance between Markers (m) <sup>5</sup>	6	6	9	9	12
	Minimum Number of Markers for Taper	at least 4 markers	at least 5 markers	at least 5 markers	at least 7 markers	at least 8 markers
<b>E <sup>1</sup></b>	Minimum Tangent between Tapers (m)	60	85	100	100	110
<b>F <sup>1</sup></b>	Distance between Construction Signs (m) <sup>6</sup>	30	30	60	60	80
<b>G</b>	Mobile Work: Lateral Intrusion Deterrence Gap (LIDG) (m)	–	–	35	45	50
	Stationary Work: Lateral Intrusion Deterrence Gap (LIDG) (m)	(35)	(40)	50	60	65
<b>H <sup>1</sup></b>	Sight Distance (m)	150	150	200	250	250

1. Table A distances are based on good visibility and should be increased if visibility is poor.

2. The regulatory maximum speed posted on a highway applies under normal conditions; that is, when no construction zone or work activity is present. Guideline provisions required in OTM Book 7 are based on normal posted regulatory speed, and not on temporarily reduced construction zone regulatory or advisory speeds.

3. Shoulder taper is used for roadside work, which includes shoulder work and roadway edge work.

4. LBA and LIDG are not required, but are strongly recommend, at speeds of 60 km/h or lower. However, they should always be used for closed lanes on multi-lane roads if space permits.

5. Markers are channelizing devices. Application guidelines are shown in [Table E](#). Cones with reflective collars may be used for daytime or night-time operations on non-freeways.

6. Distance between Construction Signs ('F') also refers to the required distance for the placement of a TC Warning Sign ahead of the hazard where referenced in [Section 4.2.8.5](#) for the individual signs. For more details on the positioning and installation of signs, refer to [Section 4.2.8.4](#).



**Table B Work Zone Component Dimensions: Short and Long Duration Work (Non-freeways)**

Label	Description	Normal Posted Regulatory Speed Limit <sup>2</sup>				
		50 km/h or lower	60 km/h	70 km/h	80 km/h	90 km/h
<b>TCP</b>	Taper Length for TCP Presence (m)	15	20	25	30	30
<b>A</b> <sup>1</sup>	Taper Length for Full Lane Closure (m)	60	85	155	180	200
<b>B</b> <sup>1</sup>	Shoulder Taper (m) <sup>3</sup>	20	30	55	60	70
<b>C</b> <sup>1</sup>	Longitudinal Buffer Area (LBA) (m) <sup>4</sup>	(30)	(40)	50	60	75
<b>D</b>	Maximum Distance between Markers (m) <sup>5</sup>	6	9	9	12	12
	Minimum Number of Markers for Taper	at least 5 markers	at least 7 markers	at least 9 markers	at least 11 markers	at least 13 markers
<b>E</b> <sup>1</sup>	Minimum Tangent between Tapers (m)	60	85	155	180	200
<b>F</b> <sup>1</sup>	Distance between Construction Signs (m) <sup>6</sup>	50	90	120	140	150
<b>G</b>	Mobile Work: Lateral Intrusion Deterrence Gap (LIDG) (m)	-	-	35	45	50
	Stationary Work: Lateral Intrusion Deterrence Gap (LIDG) (m)	(35)	(40)	50	60	65
<b>H</b> <sup>1</sup>	Sight Distance (m)	150	150	200	250	250

1. Table B distances are based on good visibility and should be increased if visibility is poor.
2. The regulatory maximum speed posted on a highway applies under normal conditions; that is, when no construction zone or work activity is present. Guideline provisions required in OTM Book 7 are based on normal posted regulatory speed, and not on temporarily reduced construction zone regulatory or advisory speeds.
3. Shoulder taper is used for roadside work, which includes shoulder work and roadway edge work.
4. LBA and LIDG are not required, but are strongly recommend, at speeds of 60 km/h or lower. However, they should always be used for closed lanes on multi-lane roads if space permits.
5. Markers are channelizing devices. Application guidelines are shown in [Table E](#). Cones with reflective collars may be used for daytime or night-time operations on non-freeways.
6. Distance between Construction Signs ('F') also refers to the required distance for the placement of a TC Warning Sign ahead of the hazard where referenced in [Section 4.2.8.5](#) for the individual signs. For more details on the positioning and installation of signs, refer to [Section 4.2.8.4](#).

**Table C Work Zone Component Dimensions: Freeways**

Label	Description	Normal Posted Regulatory Speed Limit <sup>2</sup>			
		80 km/h	90 km/h	100 km/h	110 km/h
<b>A</b> <sup>1</sup>	Taper Length for Full Lane Closure (m)	220	250	300	300
<b>B</b> <sup>1</sup>	Shoulder Taper (m) <sup>3</sup>	75	85	100	100
<b>C</b> <sup>1</sup>	Longitudinal Buffer Area (LBA) (m)	60	75	95	110
<b>D</b>	Maximum Distance between Markers (m) <sup>5</sup>	12	24	24	24
<b>E</b> <sup>1</sup>	Minimum Tangent between Tapers (m)	220	250	300	300
<b>F</b> <sup>1</sup>	Distance between Construction Signs (m) <sup>6</sup>	160	180	200	200
<b>G</b>	Mobile Work: Lateral Intrusion Deterrence Gap (LIDG) (m)	45	50	55	60
	Stationary Work: Lateral Intrusion Deterrence Gap (LIDG) (m) <sup>4</sup>	60	65	70	75

1. Table C distances are based on good visibility and should be increased if visibility is poor.
2. The regulatory maximum speed posted on a highway applies under normal conditions; that is, when no construction zone or work activity is present. Guideline provisions required in OTM Book 7 are based on normal posted regulatory speed, and not on temporarily reduced construction zone regulatory or advisory speeds.
3. Shoulder taper is used for roadside work, which includes shoulder work and roadway edge work.
4. For freeways, the required protection for stationary work operations are LBA, Buffer Vehicle, and LIDG.
5. Markers are channelizing devices. Application guidelines are shown in [Table E](#). Cones with reflective collars may be used for daytime ID, VSD, or SD operations only. Construction markers or flexible drums must be used for all other conditions.
6. Distance between Construction Signs ('F') also refers to the required distance for the placement of a TC Warning Sign ahead of the hazard where referenced in [Section 4.2.8.5](#) for the individual signs. For more details on the positioning and installation of signs, refer to [Section 4.2.8.4](#).

Table D Typical Usage of Signs through a Temporary Work Zone

Sign No.	Sign Name	Advance Warning Area	Approach Area	Transition Area	Longitudinal Buffer Area	Work Area	Termination Area
TC-1	Construction Ahead	X					
TC-1A	Construction 1 km Ahead	X					
TC-1B	Construction 2 km Ahead	X					
TC-2A	Road Work (square A frame)		X			X	
TC-2B	Road Work (diamond portable sign stand)		X			X	
TC-3	Lane Closed Ahead		X				
TC-4	Lane Closure Arrow			X			
TC-5	Detour Ahead	X					
TC-5A	Detour 1 km Ahead	X					
TC-5B	Detour 2 km Ahead	X					
TC-7	Detour-Turn Off/Diversion		X	X		X	
TC-7tA	Road Closed Tab		X	X		X	
TC-7tB	Local Traffic Only Tab		X	X		X	
TC-9	Roadside Diversion Warning		X				
TC-10	Detour Markers	X	X				
TC-11	Narrow Lanes		X			X	
TC-12	Flashing Arrow Board		X	X			
TC-12	Flashing Arrow Board (Truck Mounted)		X	X		X	
TC-13	Pavement Ends	X	X	D	D	X	D <sup>1</sup>
TC-14	Bump Ahead	X	X	D	D	X	D <sup>1</sup>
TC-15	Bump	X	X	D	D	X	D <sup>1</sup>
TC-16	Turn & Curve	X	X	D	D	X	X
TC-17t	Advisory Speed Tab	X	X			X	X
TC-18	Chevron Alignment	X	X	X	D	X	X

1. Consider increasing the work area to include the signs before the termination area.

X = Typical Use

D = Discouraged

Sign No.	Sign Name	Advance Warning Area	Approach Area	Transition Area	Longitudinal Buffer Area	Work Area	Termination Area
TC-19	Grooved Pavement	X	X	D	D	X	D <sup>1</sup>
TC-20	Prepare to Stop	X	X			X	D <sup>1</sup>
TC-21	Traffic Control Person Ahead		X				
TC-22	Traffic Control (STOP/SLOW) Paddle		X				
TC-23	Signals Ahead		X				
TC-23B	Automated Flagger Assistance Device		X				
TC-24	Uneven Lanes	X	X	D	D	X	X
TC-25	Lane Designation Direction			X			
TC-27	Do Not Pass When Flashing (mobile)	X	X	X	X	X	X
TC-31	Truck Entrance			D	D	X	X
TC-32	Temporary Bridge	X	X	D	D	X	X
TC-33	Low Bridge Ahead	X	X	D	D	X	D <sup>1</sup>
TC-34	Two Way Traffic	X	X	D	D	X	X
TC-35	Ramp Closed Ahead	X	X	D	D	X	D <sup>1</sup>
TC-36	Maximum Speed (advisory)	X	X			X	
TC-37	Soft Shoulders	X	X	D	D	X	X
TC-39	No Exit	Used on side roads where no exit exists					
TC-40	Pedestrian Direction	May be used off road in all areas					
TC-41	Bicycle Lane Detour	X	X				
TC-42	Bicycle Lane Detour Ends						X
TC-43	Bicycle Lane Closed		X				
TC-44	Do Not Use Radio Transmitter	X					
TC-45	Resume Use of Radio Transmitter						X
TC-61	New Roadway Open	X					

1. Consider increasing the work area to include the signs before the termination area.

X = Typical Use

D = Discouraged

Sign No.	Sign Name	Advance Warning Area	Approach Area	Transition Area	Longitudinal Buffer Area	Work Area	Termination Area
TC-62	Alternate Highway Route	X					
TC-64	Road Closing/Restriction Notice	X				X	
TC-65	Road Closing Notice	X				X	
TC-66 to TC-81	Information Signs	X					
TC-90	Speed Fines Doubled		X	X	X	X	
TC-101	Share the Road		X				
TC-102	Share Use Lane Single File		X				
Ra-2	YIELD			X			
Rb-1	Maximum Speed (regulatory)	X	X			X	
Rb-10	No Straight Through		X	X	X	X	
Rb-11	No Right Turn		X	X	X	X	
Rb-12	No Left Turn		X	X	X	X	
Rb-25	Keep Right (Rb-25R) or Keep Left (Rb-25L)			X		X	
Rb-31	Do Not Pass	X	X			X	
Rb-41 to Rb-47	Turn Lane Designation			X		X	
Rb-66	Motor Vehicle Passing Prohibited		X				
Rb-70	Dismount and Walk			X			
Rb-90A	Construction Zone Begins	X					
Rb-90B	Construction Zone Ends						X
Rb-91	Yield to Oncoming Traffic			X			
Rb-92	Road Closed					X	
Wb-1A	Yield Ahead		X				
	Portable Variable Message Signs	X				X	

1. Consider increasing the work area to include the signs before the termination area.

X = Typical Use

D = Discouraged

**Table E Usage of Channelizing Devices, Barricades, and Barriers**

	Device					
	Cones <sup>2</sup> TC-51A (450 mm)	Cones <sup>2</sup> TC-51B (700 mm) TC-51C (1000 mm)	Marker TC-52 (1200 mm)	Barrel TC-54 (1000 mm)	Barricades TC-53A TC-53B	Temporary Construction Barrier System (TCBS)
<b>Zone Painting</b>	ID, VSD, SD	SD	No	No	Not required	Not required
<b>Two-lane Roads</b>	No	ID, VSD, SD	SD, LD	SD, LD	LD <sup>1</sup>	Not required
<b>Multi-lane Roads (Non- freeways)</b>	No	ID <sup>1</sup> , VSD <sup>1</sup> , SD <sup>1</sup>	SD <sup>1</sup> , LD <sup>1</sup>	SD, LD	LD <sup>1</sup>	Required in certain scenarios <sup>4</sup>
<b>Freeways</b>	No	No	No	ID, VSD, SD, LD <sup>3</sup>	No	LD (more than 5 days)

1. For NPRS 70 km/h and lower.

2. All cones require white reflective cone collars.

3. Less than 5 days or where it is not practical to install barrier.

4. TCBS may be used to protect work zones and drivers. For example, TCBS is required for excavation work on multi-lane roads. For more information on TCBS, refer to [Section 4.5.3](#).

Legend:

ID = Intermittent Duration

VSD = Very Short Duration

SD = Short Duration

LD = Long Duration

No = Must not be used

Table F Nomenclature for Layout Decision Matrix

Abbreviation	Explanation
<b>Two-Lane, Two-Way</b>	
TG	Two-Lane, Two-Way - General
TS	Two-Lane, Two-Way - Segment
TI	Two-Lane, Two-Way - Intersection
TO	Two-Lane, Two-Way - Roundabout
<b>Multi-Lane Undivided</b>	
UG	Multi-Lane, Undivided - General
US	Multi-Lane, Undivided - Segment
UI	Multi-Lane, Undivided - Intersection
UO	Multi-Lane, Undivided - Roundabout
UR	Multi-Lane, Undivided - Ramp
<b>Multi-Lane Divided</b>	
DG	Multi-Lane, Divided - General
DS	Multi-Lane, Divided - Segment
DI	Multi-Lane, Divided - Intersection
DO	Multi-Lane, Divided - Roundabout
DR	Multi-Lane, Divided - Ramp
<b>Freeway</b>	
FG	Freeway - General
FS	Freeway - Segment
FR	Freeway - Ramp

**Table G Decision Matrix: Layouts**

Closure Type	Typical Layout Title	Duration				
		Mobile	ID	VSD	SD	LD
<b>Two-Lane, Two-Way</b>						
<b>General</b>						
	Designated Construction Zone Signing					TG-1
	Reduced Speed Zone Signing					TG-2
<b>Segment</b>						
<b>Shoulder/Intermittent</b>	Intermittent Work		TS-1	TS-2	TS-3	
	Shoulder Work		TS-4			TS-5
<b>Encroachment/Shift/Diversion</b>	Lane Encroachment		TS-6			TS-7
	Parking Lane Shift					TS-8
	Partial Lane Shift: Wide Platforms					TS-9
	Roadside Diversion					TS-10
<b>1 Lane Closed</b>	Zoning Painting	TS-11				
	Lane Closed or Occupied	TS-12				
	Lane Closed or Occupied (Yield to Oncoming Traffic)		TS-13			
	Lane Closed or Occupied (Traffic Control Persons)			TS-14	TS-15	
	Lane Closed (Portable Lane Control Signals)				TS-16	
	Lane Closed (Yield to Oncoming Traffic)			TS-17	TS-18	
	Lane Closed (Automated Flagger Assistance Device)			TS-19		
<b>2 Lanes Closed/Detour</b>	Route Detour (Alternative Roads)					TS-21
	Detour Signs and Devices					TS-22
<b>Pedestrian/Cyclist Accommodation</b>	Pedestrian Detour: Sidewalk Closure					TS-23
	Bicycle Lane Diversion: Bicycle Lane Shift				TS-24	TS-25
	Bicycle Lane Diversion: Temporary Path					TS-26
	Bicycle Lane Diversion: Single File					TS-27
<b>Intersection</b>						
<b>Shoulder/Intermittent</b>	Intermittent Work: Intersection		TI-1	TI-2	TI-3	
<b>1 Lane Closed</b>	Zoning Painting: Intersection Turn Arrows			TI-4	TI-5	
	Zoning Painting: Intersection Stoplines and Crosswalks			TI-6	TI-7	
	Intersection: Near-Side Lane Closed (TCP)			TI-8	TI-9	
	Intersection: Far-Side Lane Closed (TCP)			TI-10	TI-11	
	Work in Intersection: (TCP)			TI-12	TI-13	
	Intersection: Far-Side Lane Closed (Detour)					TI-14
	Work in Intersection: Near-Side Lane Closed (Detour)					TI-15
<b>Pedestrian/Cyclist Accommodation</b>	Pedestrian Detour: Crosswalk Closure					TI-16
	Pedestrian Detour: Crosswalk and Sidewalk Closure					TI-17
	Cyclist: Detour					TI-18
	Bicycle Lane Closed: Dismount and Walk					TI-19
<b>Roundabout</b>						
<b>Encroachment/Shift/Diversion</b>	Roundabout: Encroachment			TO-1	TO-2	
<b>1 Lane Closed</b>	Roundabout: Quadrant Closed (Traffic Control Persons)					TO-3
<b>2 Lanes Closed/Detour</b>	Roundabout: One Exit Closed (Detour)					TO-4



Closure Type	Typical Layout Title	Duration				
		Mobile	ID	VSD	SD	LD
<b>Multi-Lane Undivided</b>						
<b>General</b>						
	Designated Construction Zone Signing					UG-1
	Reduced Speed Zone Signing					UG-2
<b>Segment</b>						
<b>Shoulder/Intermittent</b>	Intermittent Work		US-1	US-2	US-3	
	Shoulder Work		US-4			US-5
<b>Encroachment/Shift/Diversion</b>	Lane Encroachment		US-6			US-7
	Parking Lane Closed			US-8		US-9
	Partial Lane Shift: Narrow Lanes					US-10
	Lane Realignment					US-11
<b>1 Lane Closed</b>	Zone Painting: Right or Left Lane Closed	US-12				
	Lane Closed of Occupied		US-13			
	Left Lane Closed or Occupied		US-14			
	Two-Way Left Turn Lane Closed			US-15		US-16
	Lane Closed					US-17
	Left Lane Closed					US-18
	Passing Lanes: Single-Lane Direction Closed					US-19
	Passing Lanes: Centre Lane Closed					US-20
<b>2 Lanes Closed/Detour</b>	Four Lane Road: Two Lanes Closed					US-21
	Five Lane Road: Two Through Lanes Closed					US-22
	Five Lane Road: Through Lane and Left Turn Lane Closed					US-23
	Six Lane Road: Center Lane or Two Lanes Closed					US-24
	Route Detour (Alternative Roads)					US-25
	Detour Signs and Devices					US-26
<b>Pedestrian/Cyclist Accommodation</b>	Pedestrian Accommodation: Vehicle Encroachment on Road/Sidewalk			US-27		US-28
	Pedestrian Accommodation: Mid-Block Sidewalk Detour onto Roadway					US-29
	Pedestrian Detour: Sidewalk Closure					US-30
	Bicycle Lane Diversion: Bicycle Lane Shift				US-31	US-32
	Bicycle Lane Diversion: Temporary Path					US-33
	Bicycle Lane Diversion: Single File					US-34
<b>Intersection</b>						
<b>1 Lane Closed</b>	Zone Painting: Intersection Turn Arrows			UI-1	UI-2	
	Zone Painting: Intersection Left Lane Closed			UI-3	UI-4	
	Zone Painting: Intersection Right Lane Closed			UI-5	UI-6	
	Intersection: Near-Side Right or Left Through Lane Closed			UI-7		UI-8
	Intersection: Right Turn Lane Closed			UI-9		UI-10
	Intersection: Left Turn Lane Closed			UI-11		UI-12
	Intersection: Far-Side Lane Closed			UI-13		UI-14
	Intersection: Lane Adjacent to Right Turn Lane Closed					UI-15
	Intersection: Lane Adjacent to Left Turn Lane Closed					UI-16
	Intersection: Right Turn Lane (Far-Side Right Lane Closed)					UI-17
	Intersection: (Left Turn Lane Open) Far-Side Left Lane Closed					UI-18

Closure Type	Typical Layout Title	Duration				
		Mobile	ID	VSD	SD	LD
2 Lanes Closed/Detour	Intersection: Right Turn Lane and Adjacent Through Lanes Closed			UI-19	UI-20	
	Intersection: Left Turn and Adjacent Through Lanes Closed			UI-21	UI-22	
	Work in Intersection: Right Lane Closed				UI-23	
	Work in Intersection: Left Lane Closed				UI-24	
	Work in Intersection: Road Closed (Detour) - Option 1				UI-25	
	Work in Intersection: Two Lanes Closed - Option 2				UI-26	
Pedestrian/Cyclist Accommodation	Pedestrian Accommodation: Intersection Sidewalk Detour onto Roadway				UI-27	
	Pedestrian Detour: Crosswalk Closure				UI-28	
	Pedestrian Detour: Crosswalk and Sidewalk Closure				UI-29	
	Cyclist: Detour				UI-30	
	Bicycle Lane Closed: Dismount and Walk				UI-31	
<b>Roundabout</b>						
Shoulder/Intermittent	Roundabout: Encroachment			UO-1	UO-2	
1 Lane Closed	Roundabout: Inside Lane Partially Closed			UO-3		
	Roundabout: Outside Lane Partially Closed			UO-4		
	Roundabout: Left Exit or Partial Outside Lane Closed			UO-5		
	Roundabout: Inside Lane Closed				UO-6	
	Roundabout: Outside Lane Closed				UO-7	
	Roundabout: Left Exit or Partial Outside Lane Closed				UO-8	
2 Lanes Closed/Detour	Roundabout: One Exit Closed (Detour)				UO-9	
<b>Ramp</b>						
1 Lanes Closed	Lane Closed at Exit Ramp					UR-1
	Lane Closed at Exit Ramp with a Deceleration Lane					UR-2
	Lane Closed at Entrance Ramp					UR-3
	Lane Closed at Entrance Ramp with an Acceleration Lane					UR-4
	Ramp Closed					UR-5
	Right Developed Lane Closed					UR-6

<b>Multi-Lane Divided</b>						
<b>General</b>						
	Designated Construction Zone Signing					DG-1
	Reduced Speed Zone Signing					DG-2
<b>Segment</b>						
Shoulder/Intermittent	Intermittent Work		DS-1	DS-2	DS-3	
	Shoulder Work		DS-4			DS-5
Encroachment/Shift/Diversion	Lane Encroachment		DS-6			DS-7
	Parking Lane Closed			DS-8		DS-9
	Partial Lane Shift: Narrow Lanes					DS-10
	Lane Realignment					DS-11
1 Lane Closed	Zone Painting: Right or Left Lane Closed	DS-12				
	Lane Closed or Occupied		DS-13			
	Left Lane Closed or Occupied		DS-14			
	Lane Closed					DS-15

Closure Type	Typical Layout Title	Duration				
		Mobile	ID	VSD	SD	LD
<b>2 Lanes Closed/Detour</b>	Six Lane Road: Center Lane or Two Lanes Closed				DS-16	
	Route Detour (Alternative Roads)				DS-17	
	Detour Signs and Devices				DS-18	
<b>Pedestrian/Cyclist Accommodation</b>	Pedestrian Accommodation: Vehicle Encroachment on Road/ Sidewalk			DS-19	DS-20	
	Pedestrian Accommodation: Mid-Block Sidewalk Detour onto Roadway				DS-21	
	Pedestrian Detour: Sidewalk Closure				DS-22	
	Bicycle Lane Diversion: Bicycle Lane Shift				DS-23	DS-24
	Bicycle Lane Diversion: Temporary Path				DS-25	
	Bicycle Lane Diversion: Single File				DS-26	
<b>Intersection</b>						
<b>1 Lane Closed</b>	Zone Painting: Intersection Turn Arrows			DI-1	DI-2	
	Zone Painting: Intersection Left Lane Closed			DI-3	DI-4	
	Zone Painting: Intersection Right Lane Closed			DI-5	DI-6	
	Intersection: Near-Side Right or Left Through Lane Closed			DI-7	DI-8	
	Intersection: Right Turn Lane Closed			DI-9	DI-10	
	Intersection: Left Turn Lane Closed			DI-11	DI-12	
	Intersection: Far-Sided Lane Closed			DI-13	DI-14	
	Intersection: Lane Adjacent to Right Turn Lane Closed				DI-15	
	Intersection: Lane Adjacent to Left Turn Lane Closed				DI-16	
	Intersection: Right Turn Lane (Far-Sided Right Lane Closed)				DI-17	
	Intersection: (Left Turn Lane Open) Far-Sided Left Lane Closed				DI-18	
	<b>2 Lanes Closed/Detour</b>	Intersection: Right Turn Lane and Adjacent Through Lanes Closed			DI-19	DI-20
Intersection: Left Turn and Adjacent Through Lanes Closed				DI-21	DI-22	
Work in Intersection: Right Lane Closed					DI-23	
Work in Intersection: Left Lane Closed					DI-24	
Work in Intersection: Road Closed (Detour) - Option 1					DI-25	
Work in Intersection: Two Lanes Closed - Option 2					DI-26	
<b>Pedestrian/Cyclist Accommodation</b>	Pedestrian Accommodation: Intersection Sidewalk Detour onto Roadway				DI-27	
	Pedestrian Detour: Crosswalk Closure				DI-28	
	Pedestrian Detour: Crosswalk and Sidewalk Closure				DI-29	
	Cyclist: Detour				DI-30	
	Bicycle Lane Closed: Dismount and Walk				DI-31	
<b>Roundabout</b>						
<b>Shoulder/Intermittent</b>	Roundabout: Encroachment			DO-1	DO-2	
<b>1 Lane Closed</b>	Roundabout: Inside Lane Partially Closed			DO-3		
	Roundabout: Outside Lane Partially Closed			DO-4		
	Roundabout: Left Exit or Partial Outside Lane Closed			DO-5		
	Roundabout: Inside Lane Closed				DO-6	
	Roundabout: Outside Lane Closed				DO-7	
	Roundabout: Left Exit or Partial Outside Lane Closed				DO-8	
<b>2 Lanes Closed/Detour</b>	Roundabout: One Exit Closed (Detour)				DO-9	

Closure Type	Typical Layout Title	Duration				
		Mobile	ID	VSD	SD	LD
<b>Ramp</b>						
<b>1 Lane Closed</b>	Intersection: Right Turn Lane and Adjacent Through Lanes Closed					DR-1
	Intersection: Left Turn and Adjacent Through Lanes Closed					DR-2
	Work in Intersection: Right Lane Closed					DR-3
	Work in Intersection: Left Lane Closed					DR-4
	Work in Intersection: Road Closed (Detour) - Option 1					DR-5
	Work in Intersection: Two Lanes Closed - Option 2					DR-6

<b>Freeway</b>						
<b>General</b>						
	Designated Construction Zone Signing					FG-1
	Reduced Speed Zone Signing					FG-2
<b>Segment</b>						
<b>Shoulder/Intermittent</b>	Shoulder Work			FS-1		FS-2
<b>Encroachment/Shift/Diversion</b>	Partial Lane Shift: Narrow Lanes					FS-3
	Lane Realignment					FS-4
<b>1 Lane Closed</b>	Zone Painting: Right or Left Lane Closed	FS-5				
	Right or Left Lane Closed or Occupied	FS-6				
	Right or Left Lane Closed				FS-7	FS-8
<b>2 Lanes Closed/Detour</b>	Six Lane Road: Centre Lane or Two Lanes Closed					FS-9
<b>Ramp</b>						
<b>1 Lanes Closed</b>	Lane Closed at Exit Ramp					FR-1
	Lane Closed at Exit Ramp with a Deceleration Lane					FR-2
	Lane Closed at Entrance Ramp					FR-3
	Lane Closed at Entrance Ramp with an Acceleration Lane					FR-4
	Ramp Closed					FR-5
	Right Developed Lane Closed					FR-6

## 6.1 General Notes to Layouts

1. A note in brackets under/beside a sign name or within a box (ie. (NPRS 70 km/h or greater) or (Long Duration)) indicates the sign is only required when that criterion is present.
2. The TC-1 and TC-2 are both required for Long Duration operations. The TC-1 is to be installed and remain in place continuously for the duration of the project. The TC-2 is to be in place to indicate workers are present and also indicates the start of the approach area. Additional TC-2 signs should be included in each work area within a long work zone that has multiple work areas. The TC-2 must be removed, covered, or dismantled and placed faced down when workers are not present. For SD only the TC-2 is required.
3. The TC-1A and TC-1B are not always shown on the Layouts. The TC-1A is required for Long Duration rural or freeway operations. Long Duration Freeway operations also require the TC-1B.
4. A work area, as shown on the Layouts, may or may not contain a work vehicle depending on the work activity. A work vehicle may be used as a traffic control device only as shown on the Layouts. If used as a traffic control device the work vehicle must have either four-way flashers (4WF) plus 360 Beacon, rotating LED amber lights, or TC-12 as indicated. Where a work vehicle is present with 4WF plus 360 Beacon, rotating LED amber lights, and/or TC-12 the work vehicle can replace markers only where indicated in the Layouts.
5. The regulatory maximum speed posted on a highway applies under normal conditions; that is, when no construction zone or work activity is present. Guideline provisions required in OTM Book 7 are based on normal posted regulatory speed, and not on temporarily reduced construction zone regulatory or advisory speeds.
6. An end taper on shoulder work is optional but encouraged.
7. Lane encroachments on freeways are not recommended except where necessary for some mobile maintenance activities. For mobile operations use [FS-1](#) maintaining a 3.5 m lane width. For stationary operations use [FS-3](#) or [FS-7](#).
8. Lane closed means lane closed or occupied.
9. Signs and devices are oriented on the Layouts in the direction of travel they are intended to provide guidance to.
10. Signs that are shown on the Layouts with a 60 m offset indicate the sign is to be repeated on the opposite shoulder.

11. The typical layouts are categorized by the geometrics of the roadway (two-lane, multi-lane non-freeway, freeway, roundabout, intersection), number and location of closed/occupied lanes, and the duration of work. They are applicable to all types of work operations, including planning, surveying and other pre-engineering activities. The only exceptions are Paving and Painting operations.

Paving operations, although included as mobile operations by Ministry of Labour Trades and Skills Development (MLTSD), are considered stationary operations for the purpose of traffic control and the appropriate SD or LD typical should be used (not mobile).

Layouts specific to Painting operations are shown in [TS-11](#), [US-12](#), [DS-12](#), [FS-5](#), [TI-4](#) to [TI-7](#), [UI-1](#) to [UI-6](#), and [DI-1](#) to [DI-6](#).

For additional requirements for Freeway Zone Painting and Freeway Paving operations see [Section 5.2.3](#) and [Section 5.2.4](#) of the office edition.

12. As required by OHSA and its regulations, Temporary Construction Barrier System (TCBS) must be used for stationary operations on freeways, to separate workers from traffic, where the duration of the work is longer than five days. Barrier-mounted delineators should be used with TCBS. Where TCBS are not feasible on freeways and a 3.0 m minimum lateral clearance from a live lane of traffic cannot be achieved, an LBA plus BV plus LIDG must be used. TCBS should also be considered for use on non-freeways where the duration is longer than five days, to separate workers from traffic or to separate opposing traffic on multi-lane undivided roads.

13. Use of BV

**Freeways:**

All Buffer Vehicles (BV) used on freeways must be Crash Trucks (CT).

For operations that require five days or less to complete, or where barriers are not feasible, CT and both an LBA and LIDG are required for stationary operations and one or more CT are required for mobile operations.

CT are not required on freeways where a lateral off set of 3.0 m or more exists between the work area and traffic.

CT are not required for ID and VSD work on freeway shoulders. CT are required for Mobile operations on freeway shoulders.















**Non-Freeways:**

BVs are not specifically required on non-freeways under the MLTSD regulations. If a BV is used on a non-freeway, the appropriate LBA and LIDG should be used for stationary operations.

On multi-lane roads for normal posted regulatory speeds of 70 km/h or higher, a CT is preferred over a blocker truck.

14. Where a Layout for ID is not presented in Table G for a listed Configuration it is not feasible to set-up, do the work, and take down the required devices within 15 minutes therefore the measures for VSD work must be used.
15. Where a Layout for VSD is not presented in Table G for a listed Configuration it is not feasible to set-up, do the work, and take down the required devices within 30 minutes therefore the measures for SD work must be used.
16. Approval of the Road Authority is required for use of traffic control devices not shown in OTM Book 7.
17. Layouts in OTM Book 7 meet most common scenarios. For situations not shown in OTM Book 7 or when Layouts require modifications to accommodate site specific conditions follow the fundamental principles in Sections 2, 3, and 4 of OTM Book 7 Office Edition.

## 6.2 Legend of Symbols used in the Typical Layouts

Legend	
Symbol	Description
	Traffic Control Devices TC-51, TC-52 or TC-54
	Sign
	Traffic Control Person (TCP)
	Work Vehicle, Sign Truck, Blocker Truck, or Crash Truck
	Flashing Amber Light
 Beacon + 4WF	Vehicle Four-Way Flashers and 360° Beacon
	Work Area
	Portable Traffic Control Signal
	Barricades: TC-53A, TC-53B or temporary concrete barrier
	Automated Flagger Assistance Device
	Portable Lane Control Signal (PLCS)
	TC-12 Arrow Mode
	TC-12 Bar Mode
	AODA-Compliant Ramp



**TG-1 Designated Construction Zone Signing**

**Two-Lane, Two-Way** Mobile Operations Intermittent Very Short Duration Short Duration Long Duration

**NOTES**

- i) The same signing is required in the opposite direction.
- ii) Recommended but not required.
- iii) Where required by contract.
- iv) Supplementary layout. This layout shall be used in conjunction with other appropriate layouts. Locations of TC-1, TC-1A, TC-1B shown in TG-1 overrides the locations shown in other layouts when used in conjunction with TG-1.

For further detail on Work Zone components, see [Table B \(Short/Long, pg. 241\)](#).

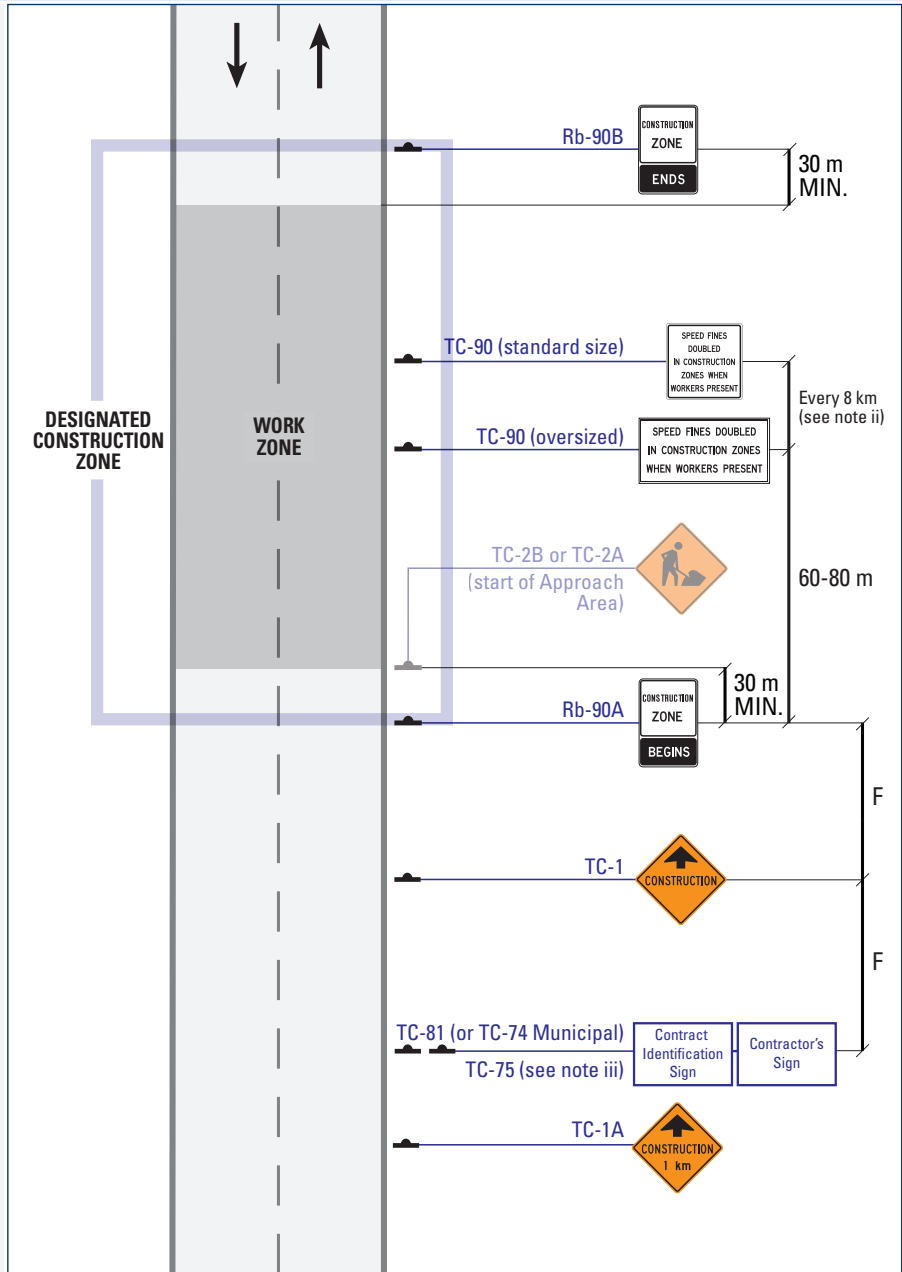

Label	Description	Normal Posted Regulatory Speed (km/h)				
		50	60	70	80	90
<b>F</b>	Distance between Construction Signs (m)	50	90	120	140	150

**TG-2 Reduced Speed Zone Signing**

**Two-Lane, Two-Way**

Mobile Operations

Intermittent

Very Short Duration

Short Duration

Long Duration

**NOTES**

- i) Refer to Regulation 615 of the Highway Traffic Act and OTM Book 5 for distance between regulatory speed limit signs.
- ii) For Regulatory Speed Reduction, a Designated Construction Zone must be established and signed as per TG-1.
- iii) The same signing is required in the opposite direction.
- iv) Reduced Speed Zone may include all of or only part(s) of the Designated Construction Zone.
- v) Additional signs may be required based on the length of zone.
- vi) Supplementary layout. This layout shall be used in conjunction with other appropriate layouts.

For further detail on Work Zone components, see [Table B \(Short/Long, pg. 241\)](#).

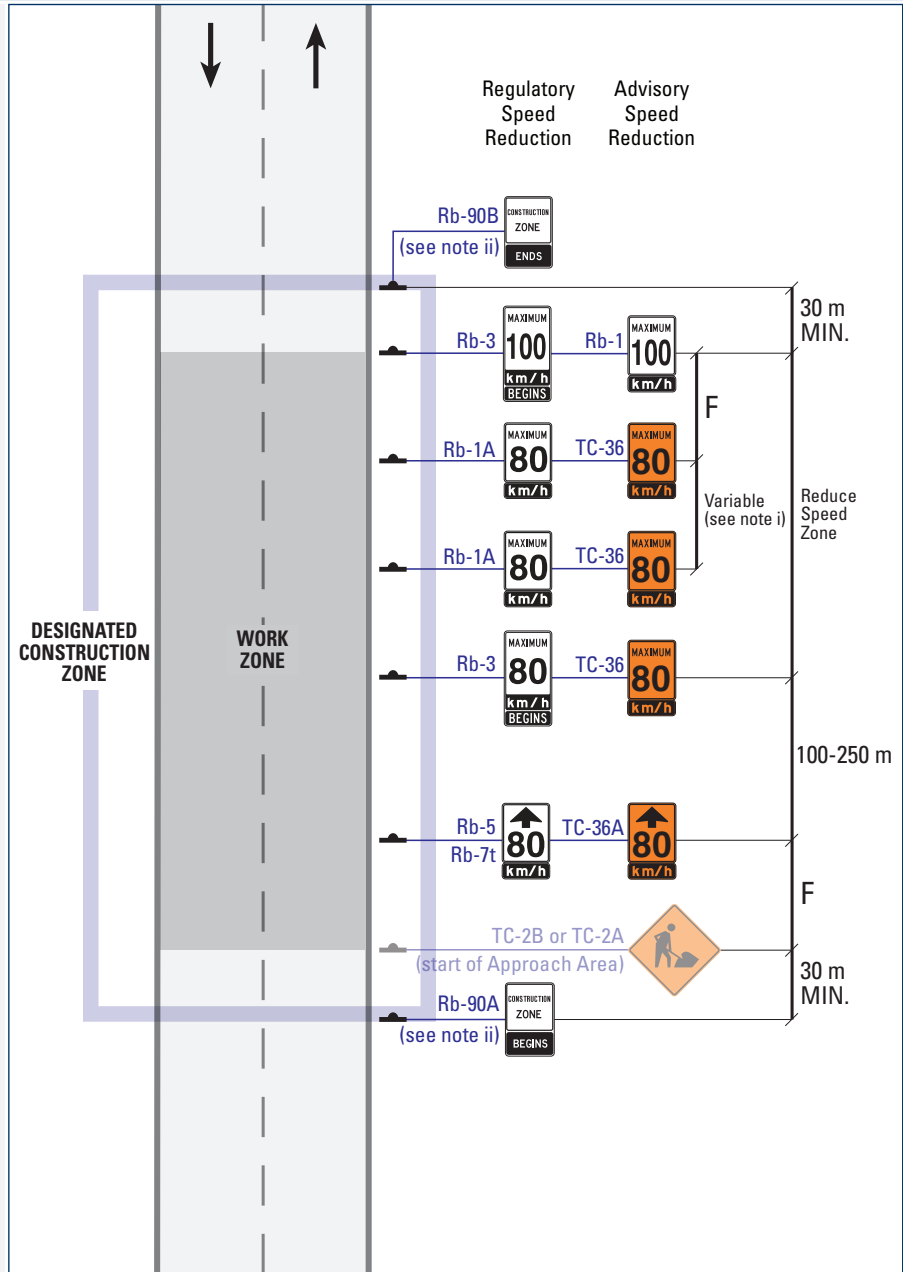

Normal Posted Regulatory Speed (km/h)

Label	Description	50	60	70	80	90
<b>F</b>	Distance between Construction Signs (m)	50	90	120	140	150

**TS-1 Intermittent Work**

Two-Lane, Two-Way    Mobile Operations    **Intermittent**    Very Short Duration    Short Duration    Long Duration

**NOTES**

Where a worker is moving within the Intermittent Work Area with only brief stationary moments, for example, pothole patching:

- Worker requires sight distance (refer to H in Table).
- Spotter(s) required when sight distance is not available.
- Where clear and constant verbal communication is not possible (i.e., distance, noise), spotter(s) and worker must use two-way communication devices.
- Where required sight distances (refer to H in Table) are present and the worker/technician's activities permit a continuous consciousness of approaching traffic, a spotter may not be required.
- Worker must not interfere with traffic.

Note: this would allow for a single worker operation (i.e., surveyor or possibly one-person pothole repair).

For further detail on Work Zone components, see [Table A \(Mobile/Intermittent/Very Short, pg. 240\)](#).

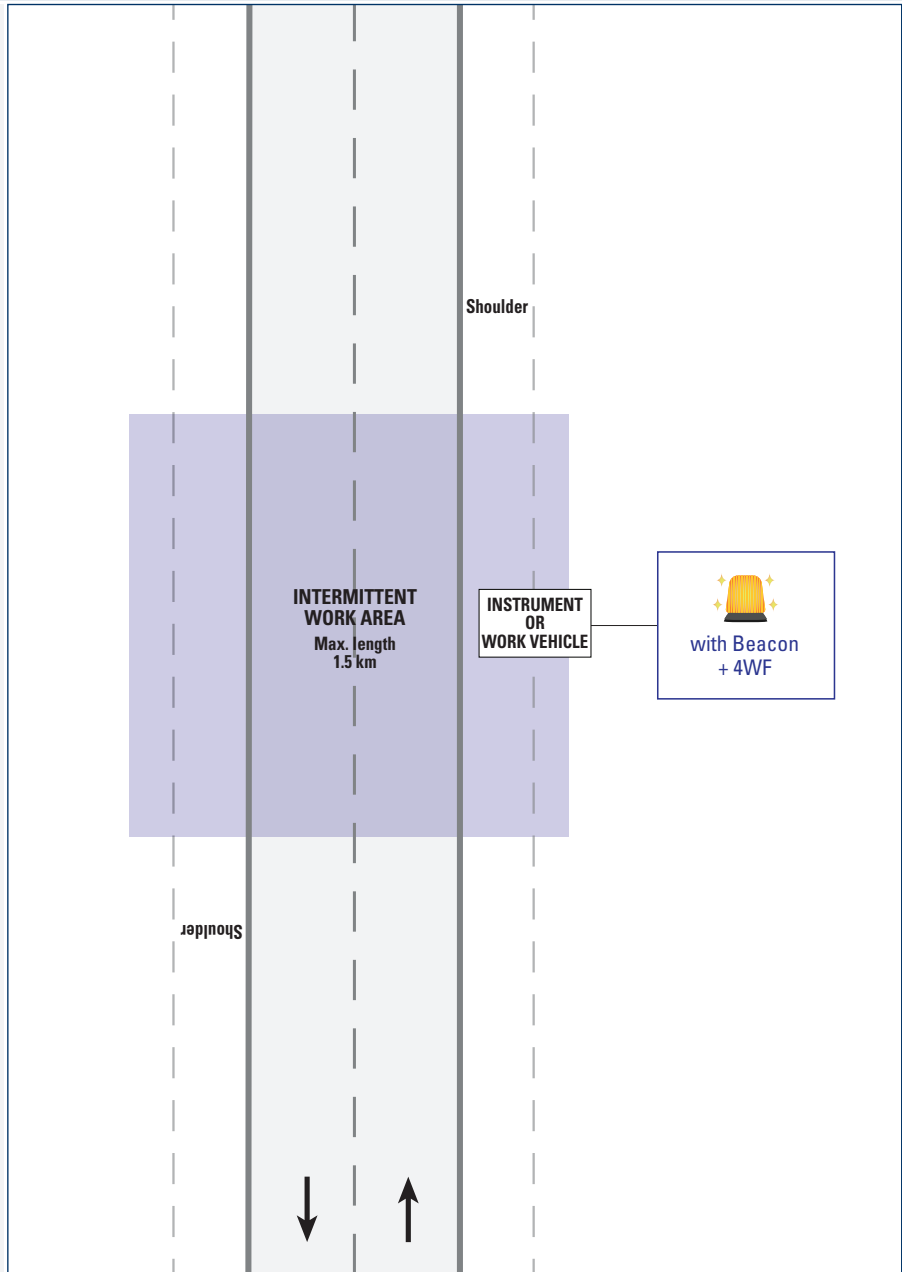

Label	Description	Normal Posted Regulatory Speed (km/h)				
		50	60	70	80	90
<b>H</b>	Sight Distance (m)	150	150	200	250	250



**TS-2 Intermittent Work**

Two-Lane, Two-Way    Mobile Operations    Intermittent    **Very Short Duration**    Short Duration    Long Duration

**NOTES**

- i) Termination Taper optional.
- ii) Work Area may or may not contain a Work Vehicle. See General Notes to Layouts #4.

**Where a worker is moving within the Intermittent Work Area with only brief stationary moments, for example, debris cleanup:**

- Worker requires sight distance (refer to H in Table).
- Spotter(s) required when sight distance is not available.
- Where clear and constant verbal communication is not possible (i.e., distance, noise), spotter(s) and worker must use two-way communication devices.
- Where required sight distances (refer to H in Table) are present and the worker/technician's activities permit a continuous consciousness of approaching traffic, a spotter may not be required.
- Worker must not interfere with traffic.

**Note:** this would allow for a single worker operation (i.e., surveyor or possibly one-person pothole repair).

For further detail on Work Zone components, see [Table A \(Mobile/Intermittent/Very Short, pg. 240\)](#).

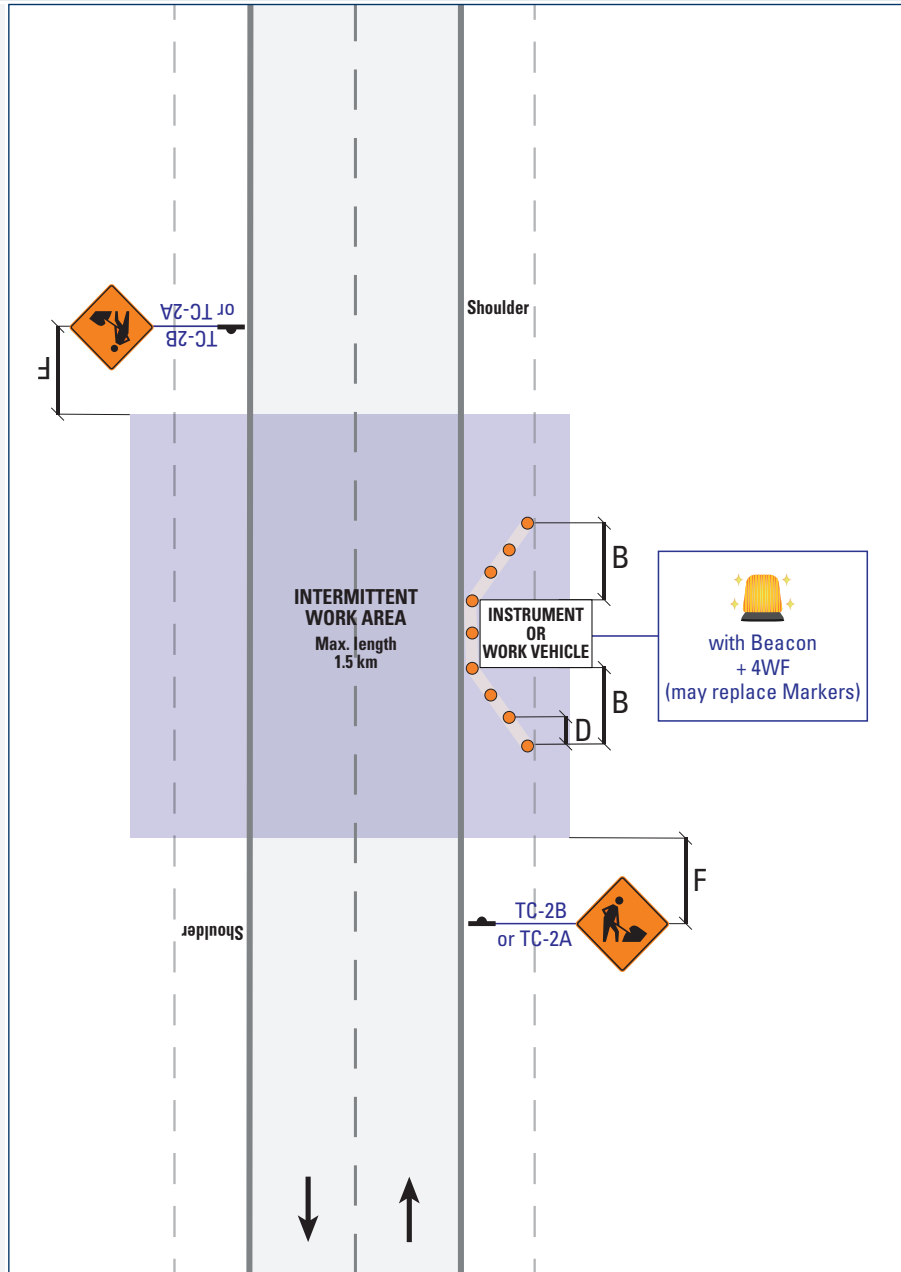

Normal Posted Regulatory Speed (km/h)

Label	Description	50	60	70	80	90
<b>B</b>	Shoulder Taper (m)	20	30	35	35	40
<b>D</b>	Maximum Distance between Markers (m)	6	6	9	9	12
	Minimum Number of Markers for Taper	4	5	5	7	8
<b>F</b>	Distance between Construction Signs (m)	30	30	60	60	80
<b>H</b>	Sight Distance (m)	150	150	200	250	250

**TS-3 Intermittent Work**

Two-Lane, Two-Way    Mobile Operations    Intermittent    Very Short Duration    **Short Duration**    Long Duration

**NOTES**

- i) Termination Taper optional.
- ii) Work Area may or may not contain a Work Vehicle. See General Notes to Layouts #4.
- iii) A Work Vehicle with a TC-12 may replace Markers.

**Where a worker is moving within the Intermittent Work Area with only brief stationary moments, for example, surveying:**

- Worker requires sight distance (refer to H in Table).
- Spotter(s) required when sight distance is not available.
- Where clear and constant verbal communication is not possible (i.e., distance, noise), spotter(s) and worker must use two-way communication devices.
- Where required sight distances (refer to H in Table) are present and the worker/technician's activities permit a continuous consciousness of approaching traffic, a spotter may not be required.
- Worker must not interfere with traffic.

**Note:** this would allow for a single worker operation (i.e., surveyor or possibly one-person pothole repair).

For further detail on Work Zone components, see [Table B \(Short/Long, pg. 241\)](#).

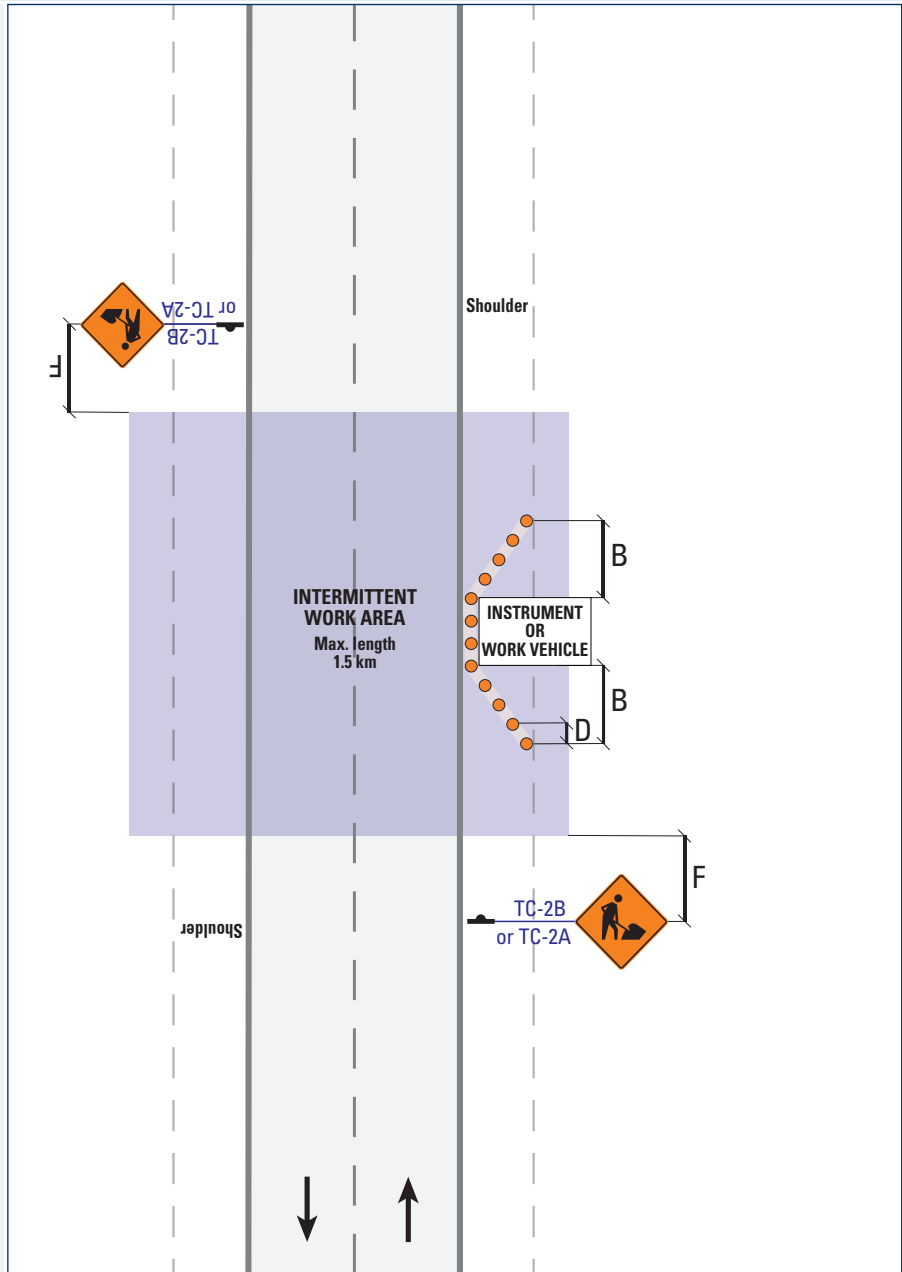

Label	Description	Normal Posted Regulatory Speed (km/h)				
		50	60	70	80	90
<b>B</b>	Shoulder Taper (m)	20	30	55	60	70
<b>D</b>	Maximum Distance between Markers (m)	6	9	9	12	12
	Minimum Number of Markers for Taper	5	7	9	11	13
<b>F</b>	Distance between Construction Signs (m)	50	90	120	140	150
<b>H</b>	Sight Distance (m)	150	150	200	250	250

**TS-4**

**Shoulder Work**

**Two-Lane, Two-Way**

**Mobile Operations**

**Intermittent**

**Very Short Duration**

Short Duration

Long Duration

**NOTES**

i) Termination Taper optional.

For further detail on Work Zone components, see [Table A \(Mobile/Intermittent/Very Short, pg. 240\)](#).

**With Work Vehicle – Mobile, Intermittent, or VSD**

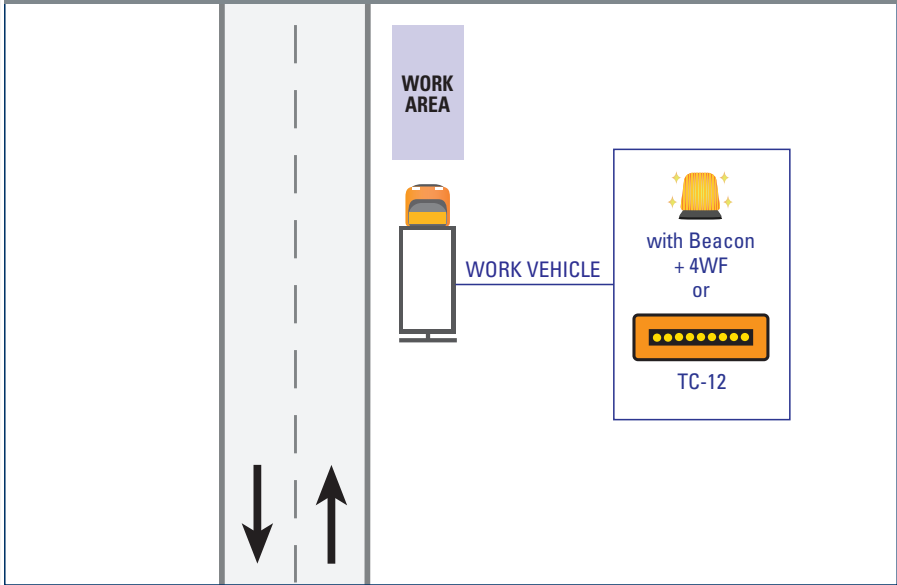

**Without Work Vehicle – VSD**

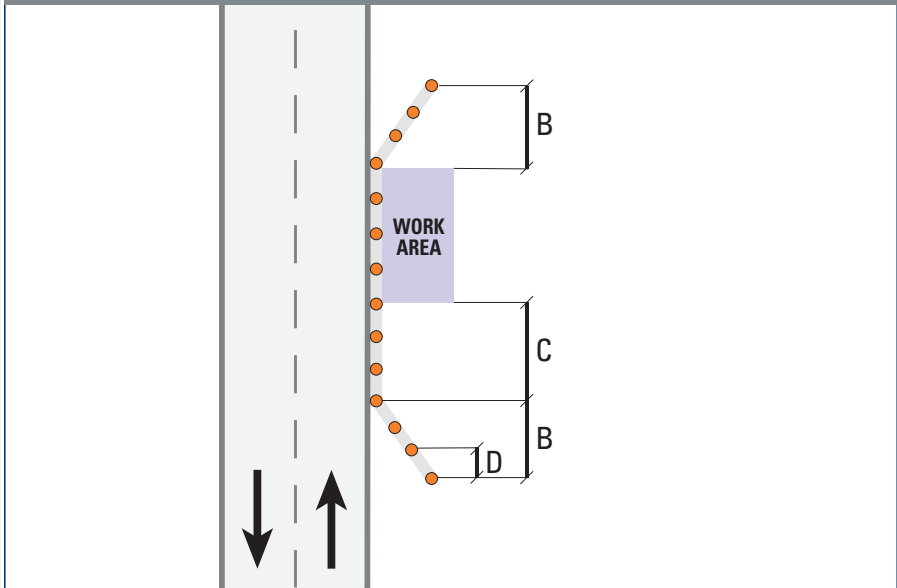

TWO-LANE  
TWO-WAY

Label	Description	Normal Posted Regulatory Speed (km/h)				
		50	60	70	80	90
<b>B</b>	Shoulder Taper (m)	20	30	35	35	40
<b>C</b>	Longitudinal Buffer Area (LBA) (m)	(30)	(40)	50	60	75
<b>D</b>	Maximum Distance between Markers (m)	6	6	9	9	12
	Minimum Number of Markers for Taper	4	5	5	7	8

**TS-5** **Shoulder Work**

**Two-Lane, Two-Way** Mobile Operations Intermittent Very Short Duration **Short Duration** Long Duration

**NOTES**

i) Termination Taper optional.

ii) Work Area may or may not contain a Work Vehicle. See General Notes to Layouts #4.

iii) A Work Vehicle with a TC-12 may replace Markers for Short Duration work.

For further detail on Work Zone components, see [Table B \(Short/Long, pg. 241\)](#).

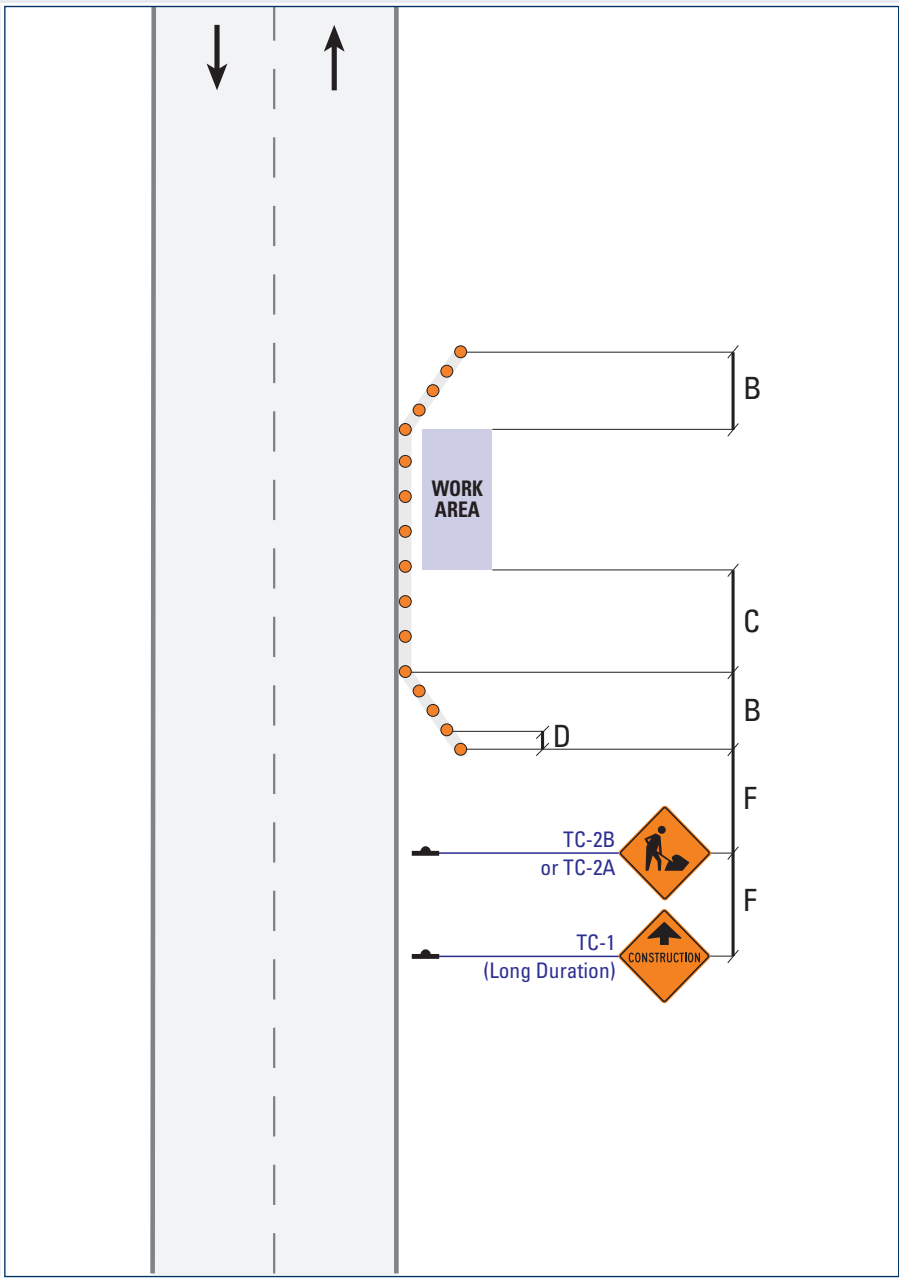

Label	Description	Normal Posted Regulatory Speed (km/h)				
		50	60	70	80	90
<b>B</b>	Shoulder Taper (m)	20	30	55	60	70
<b>C</b>	Longitudinal Buffer Area (LBA) (m)	(30)	(40)	50	60	75
<b>D</b>	Maximum Distance between Markers (m)	6	9	9	12	12
	Minimum Number of Markers for Taper	5	7	9	11	13
<b>F</b>	Distance between Construction Signs (m)	50	90	120	140	150

TWO-LANE  
TWO-WAY

**TS-6 Lane Encroachment**

**Two-Lane, Two-Way**    **Mobile Operations**    **Intermittent**    **Very Short Duration**    Short Duration    Long Duration

**NOTES**

- i) Termination Taper optional.
- ii) In addition to the minimum requirement of 3 m temporary lane width, an offset of 0.3 m to 0.6 m between Markers and the edge of the traveled lane is desirable.

For further detail on Work Zone components, see [Table A \(Mobile/Intermittent/Very Short, pg. 240\)](#).

**With Work Vehicle – Mobile, Intermittent Duration and VSD**

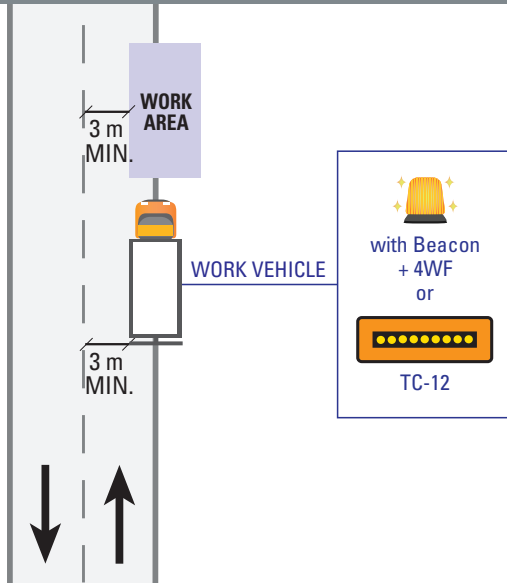

**Without Work Vehicle – VSD**

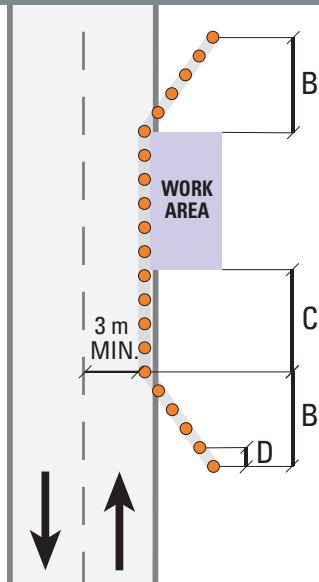

TWO-LANE TWO-WAY

Label	Description	Normal Posted Regulatory Speed (km/h)				
		50	60	70	80	90
<b>B</b>	Shoulder Taper (m)	20	30	35	35	40
<b>C</b>	Longitudinal Buffer Area (LBA) (m)	(30)	(40)	50	60	75
<b>D</b>	Maximum Distance between Markers (m)	6	6	9	9	12
	Minimum Number of Markers for Taper	4	5	5	7	8



**TS-7 Lane Encroachment**

**Two-Lane, Two-Way** Mobile Operations Intermittent Very Short Duration **Short Duration** Long Duration

**NOTES**

- i) If Available Lane Width (ALW) is less than 3 m, use Partial Lane Shift (See [TS-8, TS-9](#)) or Lane Closures ([TS-15](#) to [TS-20](#)).
- ii) In addition to the minimum requirement of 3 m temporary lane width, an offset of 0.3 m to 0.6 m between Markers and the edge of the traveled lane is desirable.
- iii) Centreline Markers are optional and are to be used if lane keeping is an issue.
- iv) On unpaved roads with Low Volume (<3000 vehicles per day):  
Where remaining roadway width is at least 6 m, and ALW is less than 3 m, use Rb-91, a distance F upstream of start of Taper, and move the TC-1 and TC-2B an additional distance F upstream.
- v) Work Area may or may not contain a Work Vehicle. See General Notes to Layouts #4.
- vi) A Work Vehicle with a TC-12 may replace Markers for Short Duration work where NPRS is 60 km/h or lower.

For further detail on Work Zone components, see [Table B \(Short/Long, pg. 241\)](#).

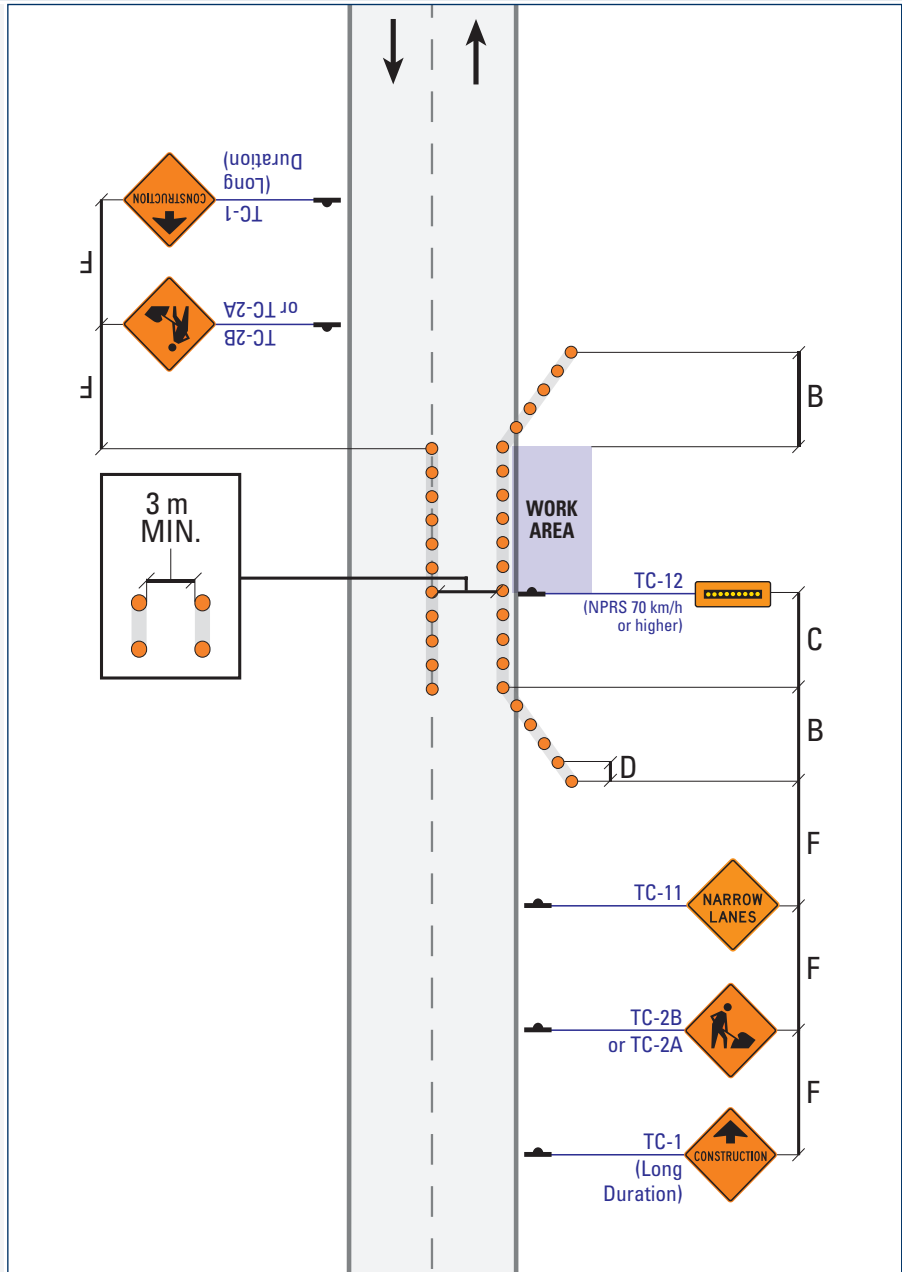

Label	Description	Normal Posted Regulatory Speed (km/h)				
		50	60	70	80	90
<b>B</b>	Shoulder Taper (m)	20	30	55	60	70
<b>C</b>	Longitudinal Buffer Area (LBA) (m)	(30)	(40)	50	60	75
<b>D</b>	Maximum Distance between Markers (m)	6	9	9	12	12
	Minimum Number of Markers for Taper	5	7	9	11	13
<b>F</b>	Distance between Construction Signs (m)	50	90	120	140	150

**TS-8 Partial Lane Shift**

**Two-Lane, Two-Way**    Mobile Operations    Intermittent    Very Short Duration    Short Duration    Long Duration

**NOTES**

- i) Remaining roadway must be at least 6 m plus the width of channelizers. A lane width must be at least 3 m in each direction.
- ii) In addition to the minimum requirement of 3 m temporary lane width, an offset of 0.3 m to 0.6 m between Markers and the edge of the traveled lane is desirable.
- iii) Traffic should not be shifted onto a surface texture different from the main roadway without a Posted Speed Reduction.

For further detail on Work Zone components, see [Table B \(Short/Long, pg. 241\)](#).

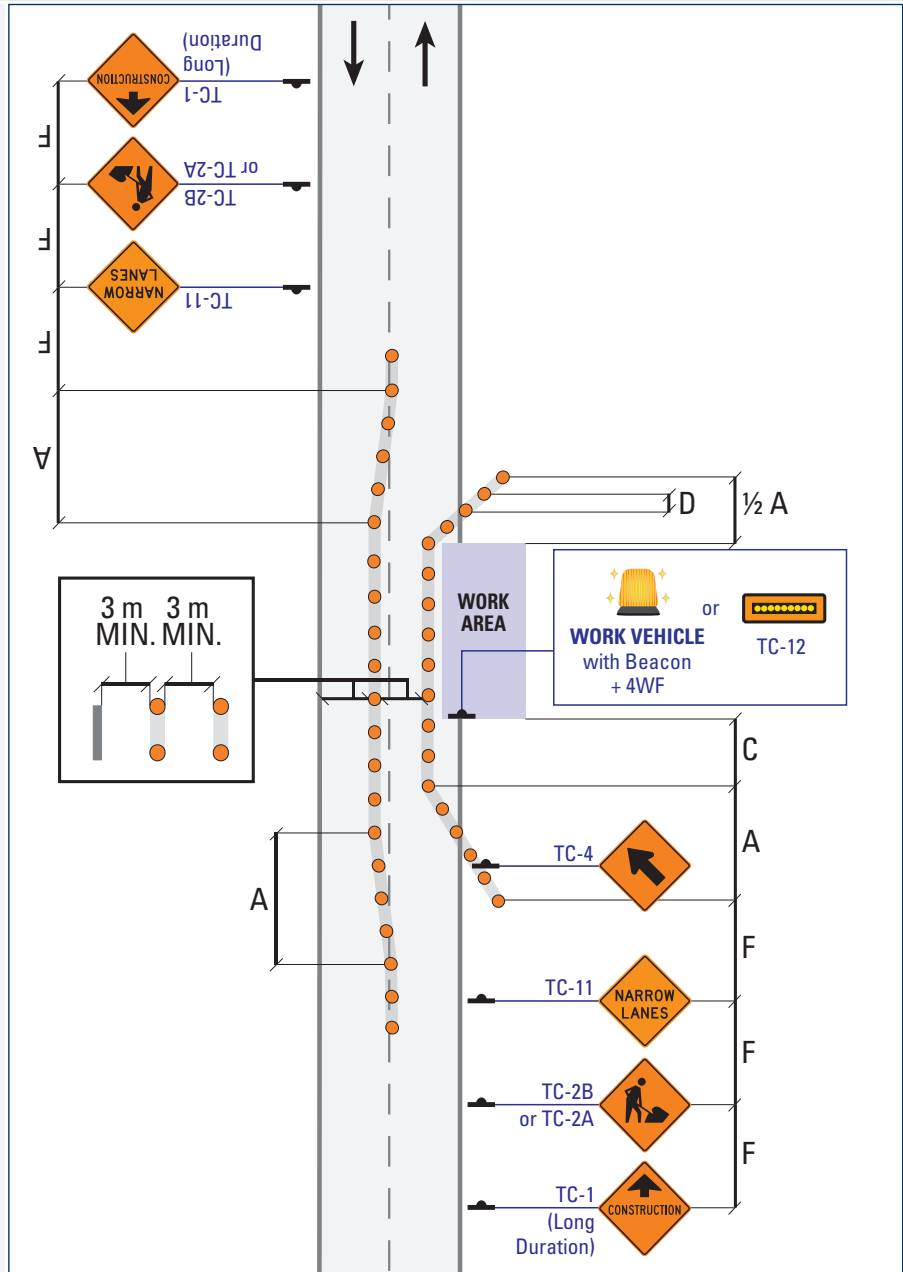

Normal Posted Regulatory Speed (km/h)

Label	Description	50	60	70	80	90
<b>A</b>	Taper Length for Full Lane Closure (m)	60	85	155	180	200
<b>C</b>	Longitudinal Buffer Area (LBA) (m)	(30)	(40)	50	60	75
<b>D</b>	Maximum Distance between Markers (m)	6	9	9	12	12
	Minimum Number of Markers for Taper	5	7	9	11	13
<b>F</b>	Distance between Construction Signs (m)	50	90	120	140	150

**TS-9 Partial Lane Shift: Wide Platform**

**Two-Lane, Two-Way**

Mobile Operations

Intermittent

Very Short Duration

Short Duration

Long Duration

**NOTES**

- i) Remaining roadway must be at least 6 m plus the width of channelizers. A lane width must be at least 3 m in each direction.
- ii) In addition to the minimum requirement of 3 m temporary lane width, an offset of 0.3 m to 0.6 m between Markers and the edge of the traveled lane is desirable.
- iii) Traffic should not be shifted onto a surface texture different from the main roadway without a Posted Speed Reduction.

For further detail on Work Zone components, see [Table B \(Short/Long, pg. 241\)](#).

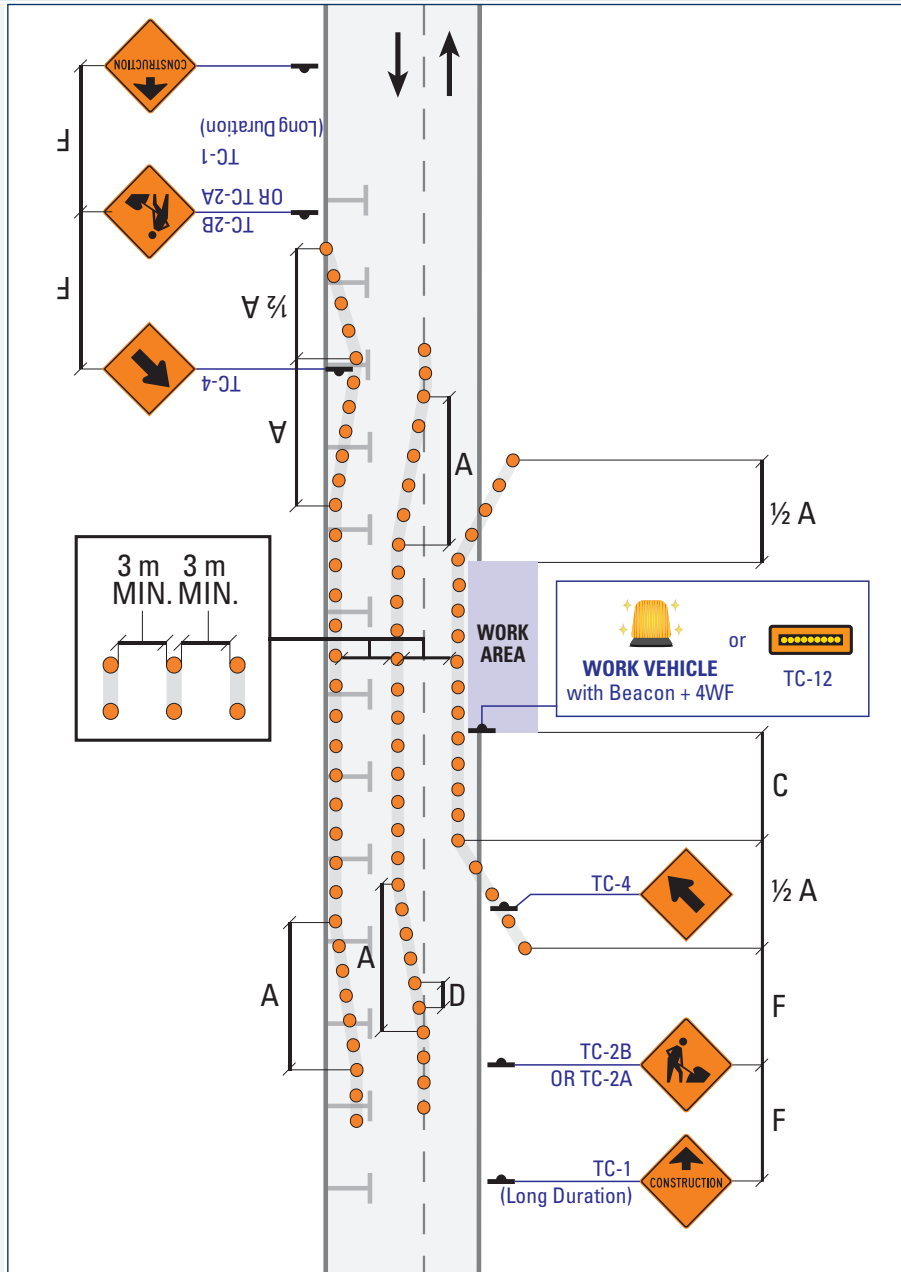

**Normal Posted Regulatory Speed (km/h)**

Label	Description	50	60	70	80	90
<b>A</b>	Taper Length for Full Lane Closure (m)	60	85	155	180	200
<b>C</b>	Longitudinal Buffer Area (LBA) (m)	(30)	(40)	50	60	75
<b>D</b>	Maximum Distance between Markers (m)	6	9	9	12	12
	Minimum Number of Markers for Taper	5	7	9	11	13
<b>F</b>	Distance between Construction Signs (m)	50	90	120	140	150

**TS-10 Roadside Diversion**

**Two-Lane, Two-Way**

Mobile Operations

Intermittent

Very Short Duration

Short Duration

Long Duration

**NOTES**

- i) Traffic should not be shifted onto a surface texture different from the main roadway without a speed reduction.
- ii) If the diversion is paved, temporary pavement markings are required, including Edge Lines, and the TC-13 should not be used.

For further detail on Work Zone components, see Table B (Short/Long, pg. 241).

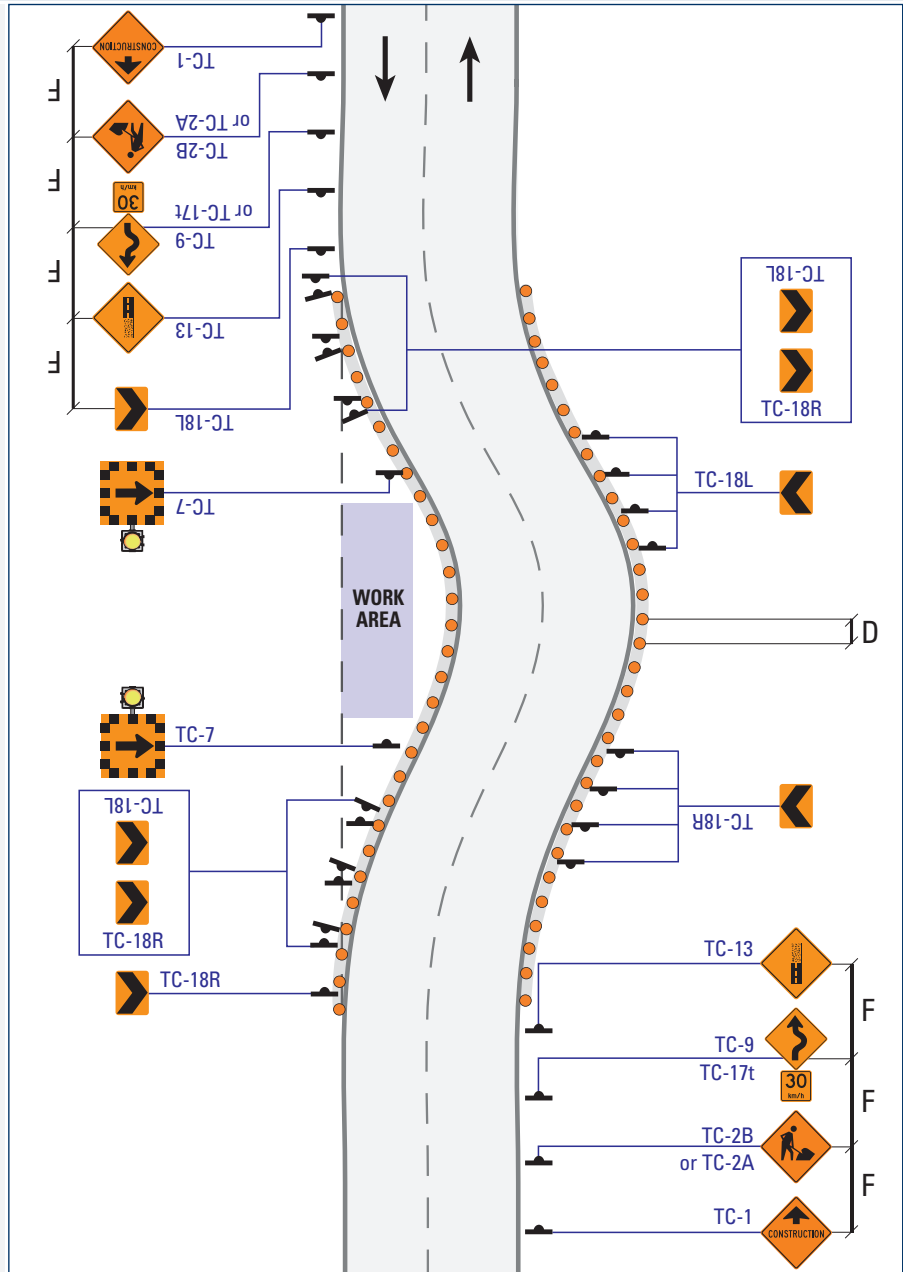

TWO-LANE TWO-WAY

Label	Description	Normal Posted Regulatory Speed (km/h)				
		50	60	70	80	90
<b>D</b>	Maximum Distance between Markers (m)	6	9	9	12	12
<b>F</b>	Distance between Construction Signs (m)	50	90	120	140	150

**TS-11 Zone Painting**

**Two-Lane, Two-Way**

**Mobile Operations**

Intermittent

Very Short Duration

Short Duration

Long Duration

**NOTES**

- i) A Crash Truck must be used on High Volume roads and/or where the NPRS is 80 km/h or higher. Road Authorities, other than MTO, may not require a Buffer Vehicle on Low Volume roads with NPRS lower than 80 km/h.
- ii) Where shoulder is Intermittent, Sign Truck should drive with traffic flow until shoulder becomes available.
- iii) The distance between Sign Truck and Buffer Vehicle may be adjusted to accommodate hills, curves, restricted visibility, or other specific conditions.
- iv) Alternately, the Sign Truck on the shoulder may have a programmable VMS displaying approved message warning of line painting operations ahead.

For further detail on Work Zone components, see [Table A \(Mobile/Intermittent/Very Short, pg. 240\)](#).

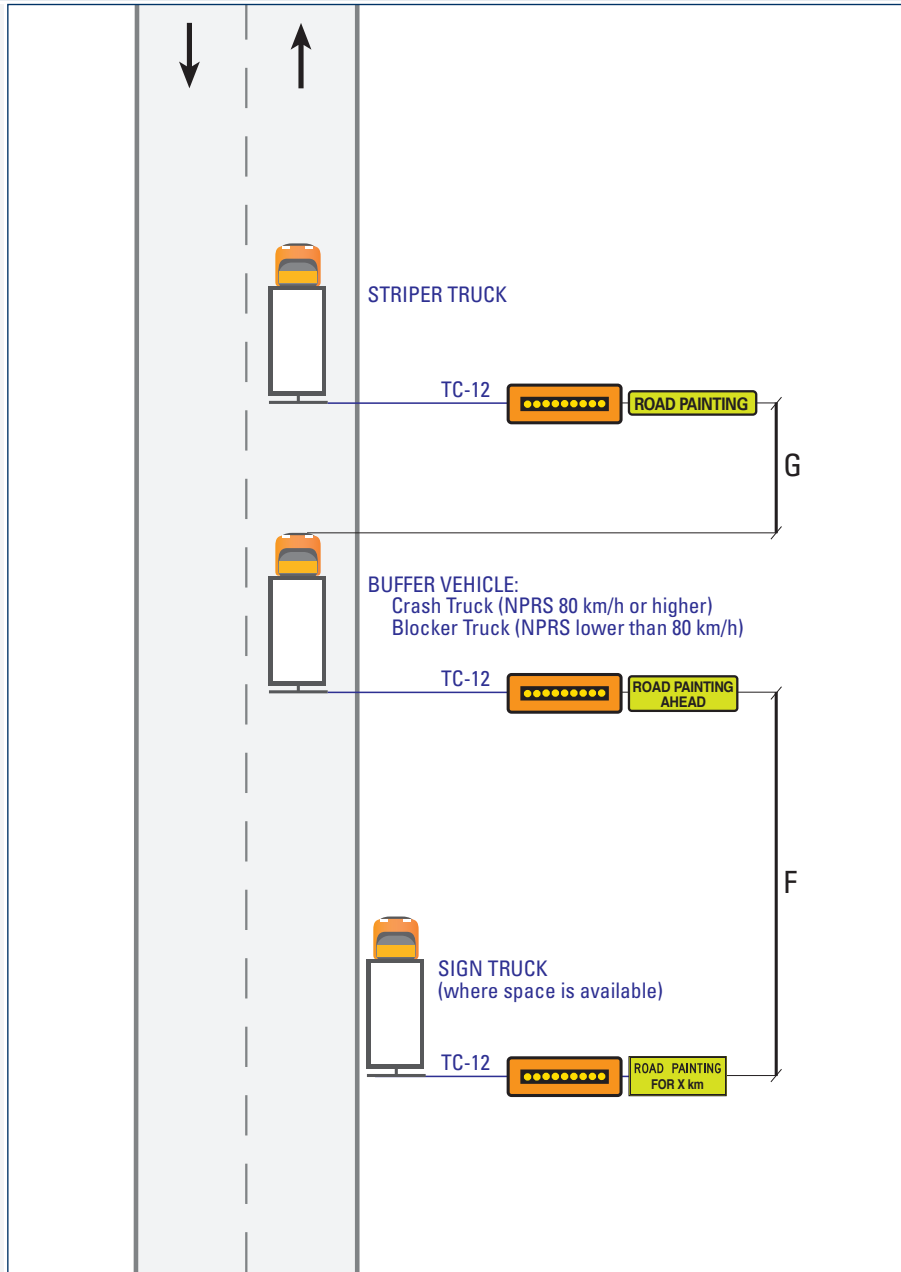

Label	Description	Normal Posted Regulatory Speed (km/h)				
		50	60	70	80	90
F	Distance between Construction Signs (m)	30	30	60	60	80
G	Mobile Work: Lateral Intrusion Deterrence Gap (LIDG) (m)	–	–	35	45	50

**TS-12**

**Lane Closed or Occupied**

**Two-Lane, Two-Way**

**Mobile Operations**

Intermittent

Very Short Duration

Short Duration

Long Duration

**NOTES**

For further detail on Work Zone components, see [Table A \(Mobile/ Intermittent/Very Short, pg. 240\)](#).



WORK VEHICLE

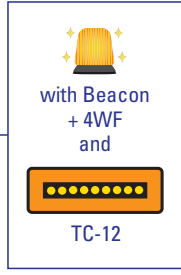

TWO-LANE  
TWO-WAY

**TS-13 Lane Closed or Occupied (Yield to Oncoming Traffic) (Low Volume Roads)**

**Two-Lane, Two-Way** Mobile Operations **Intermittent** Very Short Duration Short Duration Long Duration

**NOTES**

- i) Use only on roads with Low Traffic Volume (< 3000 vehicles per day).
- ii) To be used for short length Work Areas (< 150 m).
- iii) May also be used on roads with no centreline.
- iv) Use only where there is unobstructed visibility of oncoming traffic in both directions.
- v) Work Area may or may not contain a Work Vehicle. See General Notes to Layouts #4. If Work Vehicle has a TC-12, it must be in bar mode.
- vi) Wb-1A is not required unless sight distance (H) is not available.

For further detail on Work Zone components, see [Table A \(Mobile/Intermittent/Very Short, pg. 240\)](#).

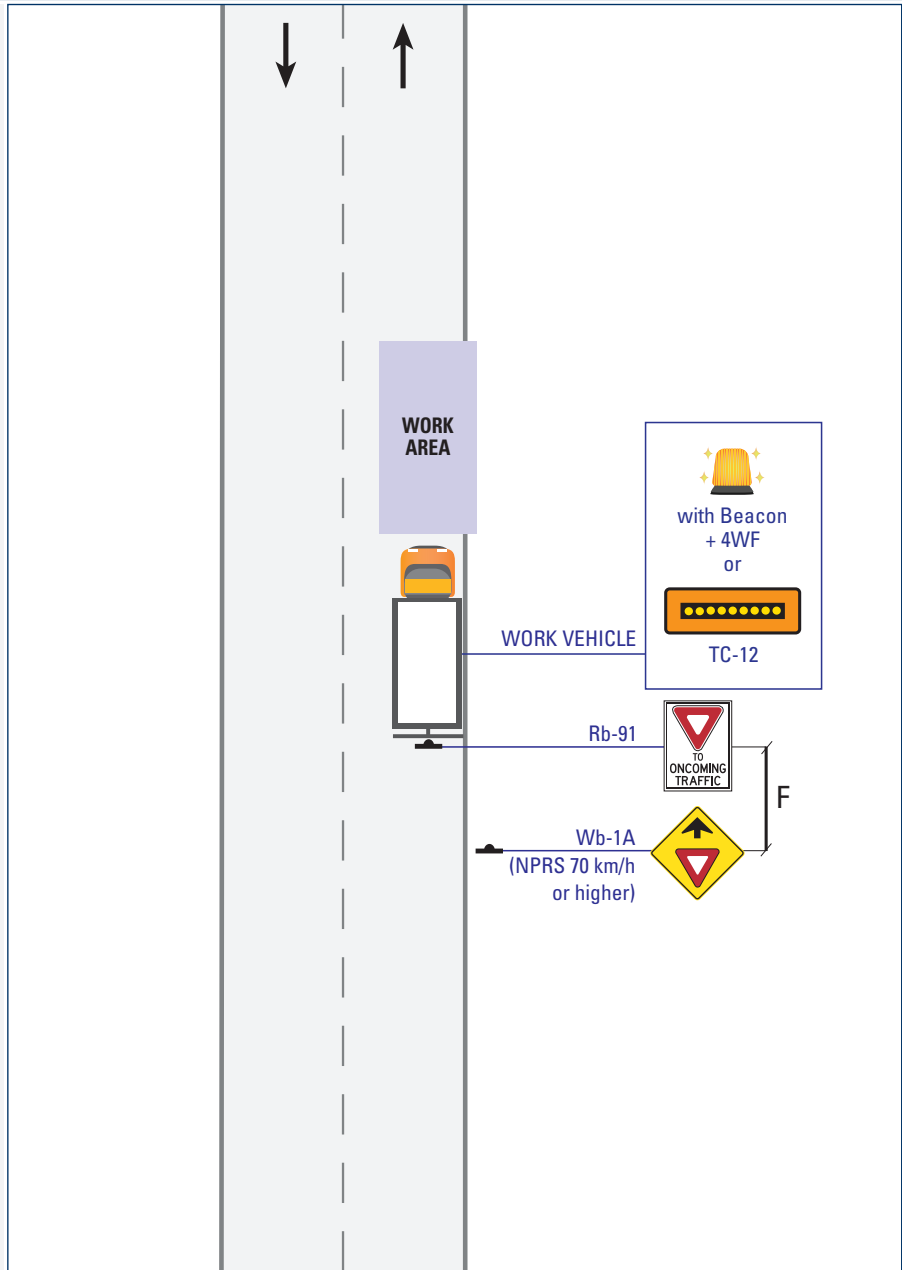

**Normal Posted Regulatory Speed (km/h)**

Label	Description	50	60	70	80	90
<b>F</b>	Distance between Construction Signs (m)	30	30	60	60	80
<b>H</b>	Sight Distance (m)	150	150	200	250	250

**TS-14 Lane Closed or Occupied (Traffic Control Persons)**

**Two-Lane, Two-Way**

Mobile Operations

Intermittent

**Very Short Duration**

Short Duration

Long Duration

**NOTES**

i) Work on Low Traffic Volume roads (<3000 vehicles per day) with a Normal Posted Regulatory Speed lower than 70 km/h, the Markers are not required.

ii) On high speed (NPRS 70 km/h or higher) or where lane keeping/compliance is an issue, consider using TS-20 Lane Closed (Traffic Control Persons).

iii) For Short Duration projects on MTO highways, it is recommended to use TS-20.

For further detail on Work Zone components see [Table A \(Mobile/Intermittent/Very Short, pg. 240\)](#), and [TCP Table \(pg. 175\)](#).

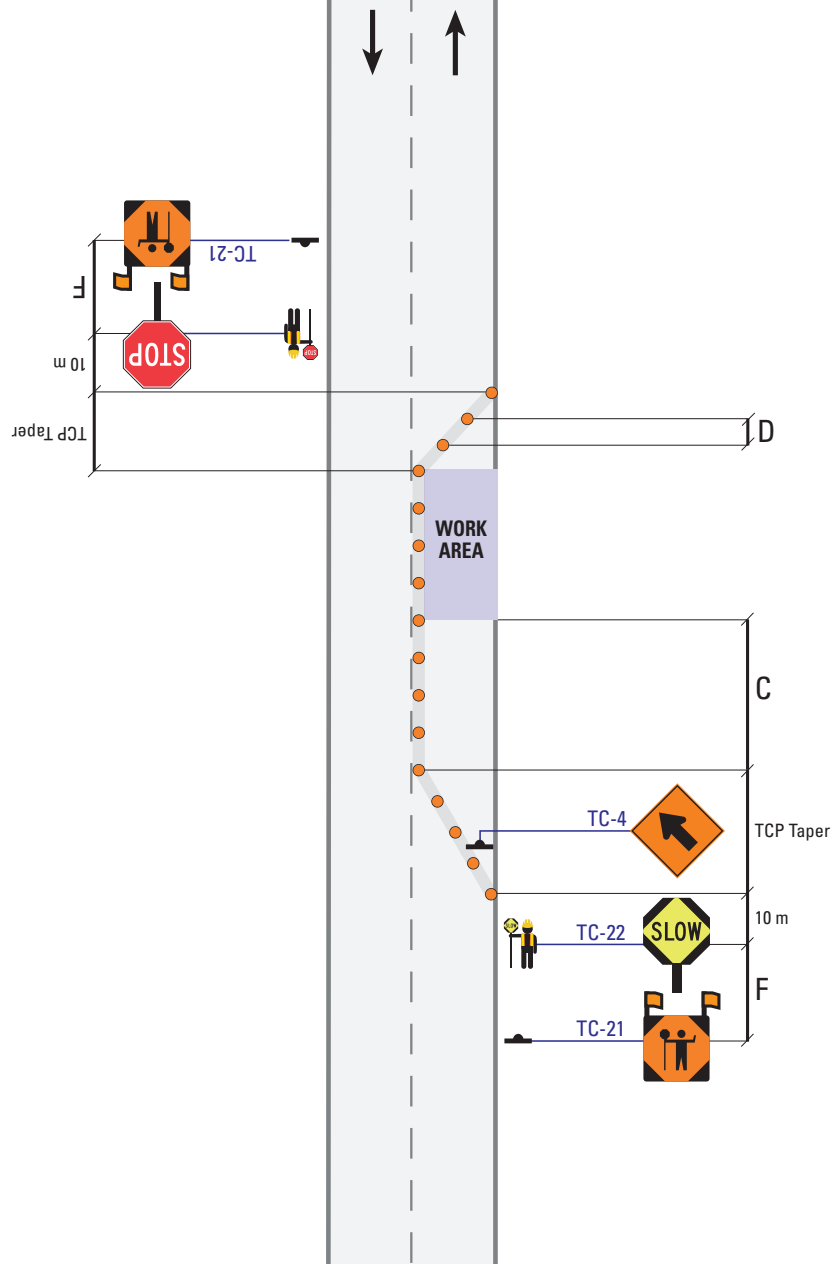

TWO-LANE TWO-WAY

Label	Description	Normal Posted Regulatory Speed (km/h)				
		50	60	70	80	90
<b>TCP</b>	Taper Length for TCP Presence (m)	15	20	25	30	30
<b>C</b>	Longitudinal Buffer Area (LBA) (m)	(30)	(40)	50	60	75
<b>D</b>	Maximum Distance between Markers (m)	6	6	9	9	12
	Minimum Number of Markers for Taper	4	5	5	7	8
<b>F</b>	Distance between Construction Signs (m)	30	30	60	60	80



**TS-15 Lane Closed or Occupied (Traffic Control Persons)**

**Two-Lane, Two-Way**

Mobile Operations

Intermittent

Very Short Duration

**Short Duration**

Long Duration

**NOTES**

i) On high speed (NPRS 70 km/h or higher) or where lane keeping/compliance is an issue, consider using TS-20 Lane Closed (Traffic Control Persons).

ii) For Short Duration projects on MTO highways, it is recommended to use TS-20.

For further detail on Work Zone components see [Table B \(Short/Long, pg. 241\)](#).

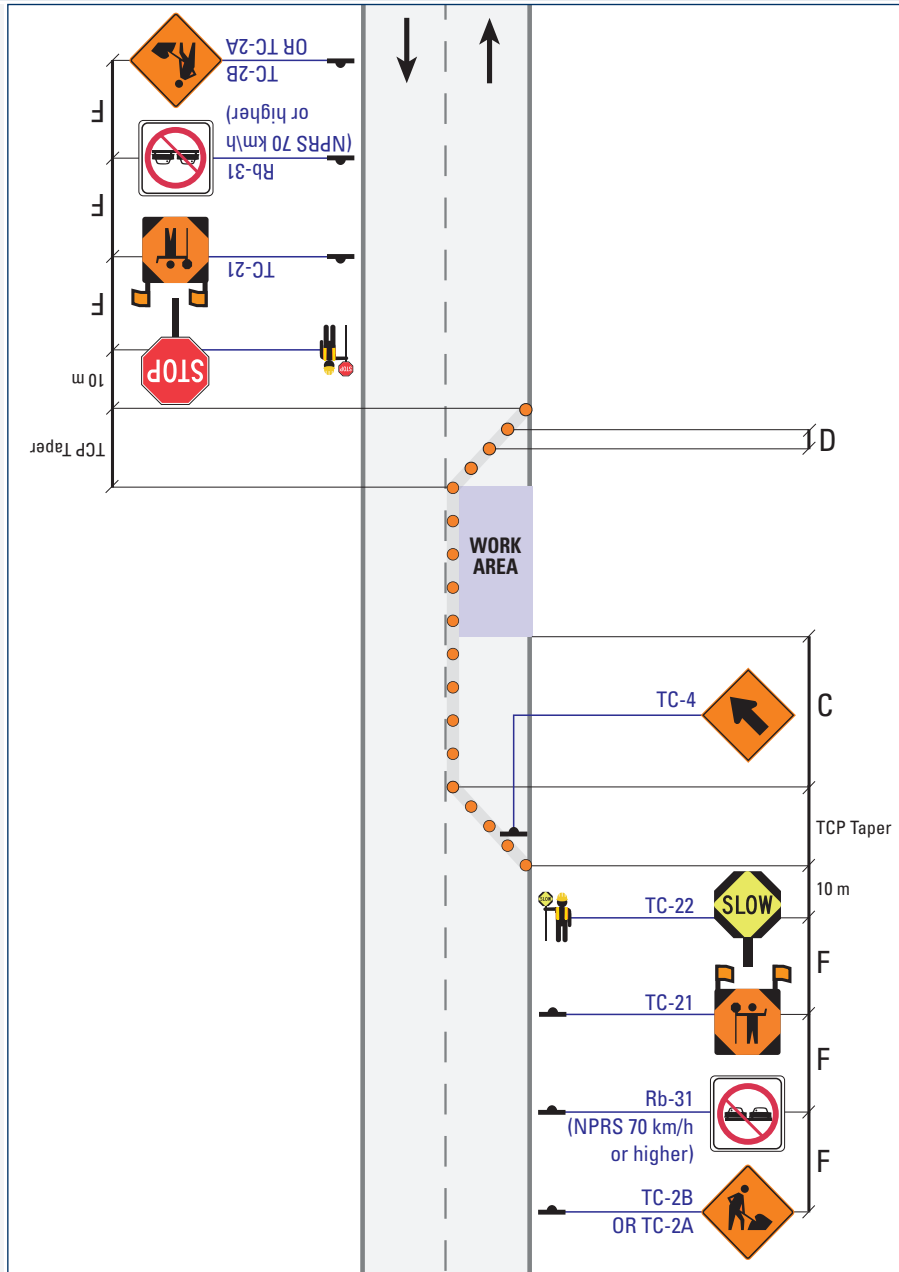

**Normal Posted Regulatory Speed (km/h)**

Label	Description	50	60	70	80	90
<b>TCP</b>	Taper Length for TCP Presence (m)	15	20	25	30	30
<b>C</b>	Longitudinal Buffer Area (LBA) (m)	(30)	(40)	50	60	75
<b>D</b>	Maximum Distance between Markers (m)	6	9	9	12	12
	Minimum Number of Markers for Taper	5	7	9	11	13
<b>F</b>	Distance between Construction Signs (m)	50	90	120	140	150

**TS-16**

**Lane Closed (Portable Lane Control Signals)**

**Two-Lane, Two-Way**

Mobile Operations

Intermittent

Very Short Duration

**Short Duration**

Long Duration

**NOTES**

i) To determine the appropriate timing of the lane control signals, see Section 4.

ii) Lane control signals are only to be used while the contractor is on site and on roads with NPRS of 90 km/h or lower. Portable signals that are to operate during Long Duration work, or when no contractor is present, are Portable Temporary Traffic Signals (PTTS) and require Road Authority approval of layout and signal timing. MTO applications require the completion of PHM-125 (see OTM Book 12).

For further detail on Work Zone components, see [Table B \(Short/Long, pg. 241\)](#).

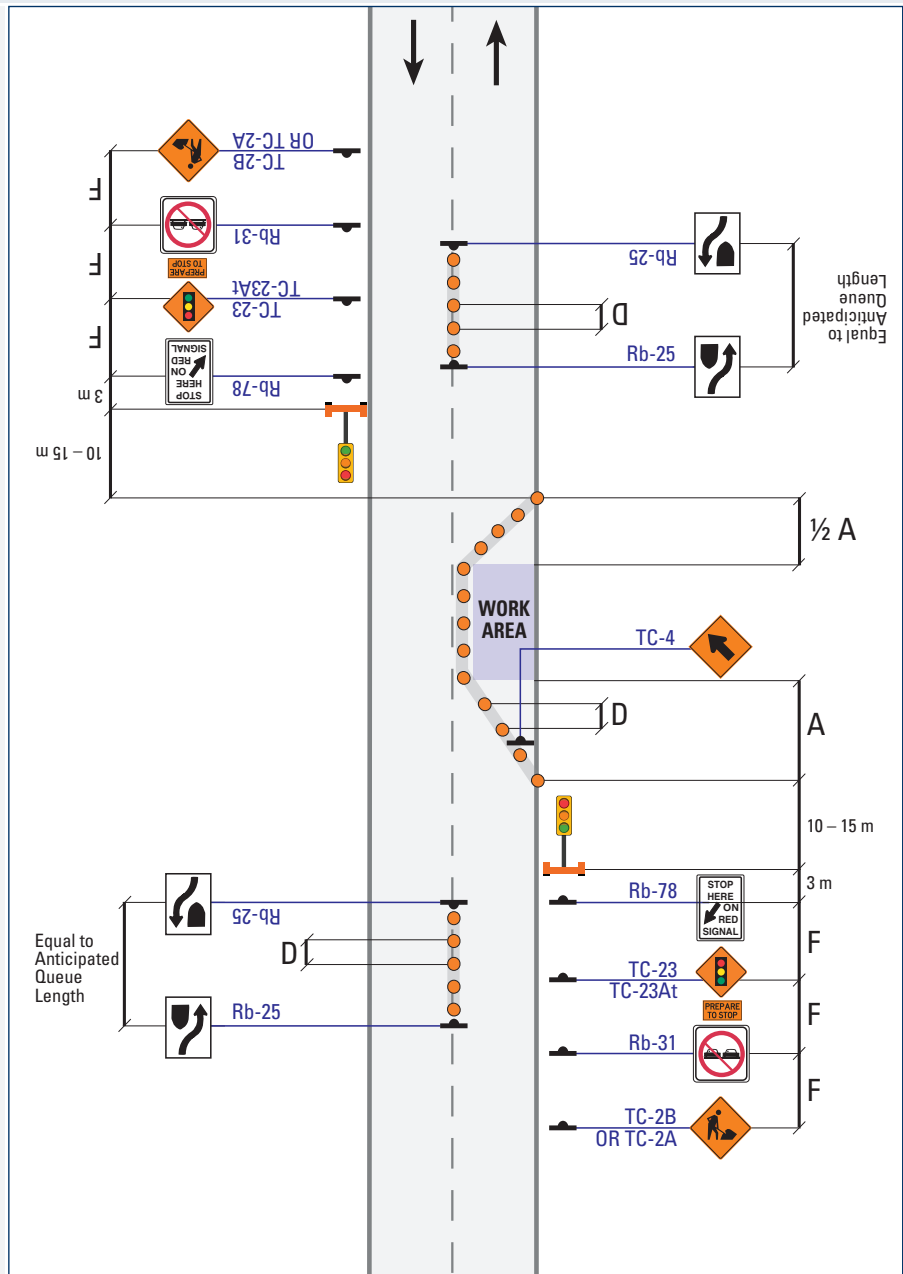

TWO-LANE  
TWO-WAY

Label	Description	Normal Posted Regulatory Speed (km/h)				
		50	60	70	80	90
<b>A</b>	Taper Length for Full Lane Closure (m)	60	85	155	180	200
<b>D</b>	Maximum Distance between Markers (m)	6	9	9	12	12
	Minimum Number of Markers for Taper	5	7	9	11	13
<b>F</b>	Distance between Construction Signs (m)	50	90	120	140	150

**TS-17 Lane Closed (Yield to Oncoming Traffic) (Low Volume Roads)**

**Two-Lane, Two-Way** Mobile Operations Intermittent **Very Short Duration** Short Duration Long Duration

**NOTES**

- i) Use only on roads with Low Traffic Volume (< 3000 vehicles per day).
- ii) To be used for short length Work Areas (<150 m).
- iii) May also be used on roads with no centreline.
- iv) Use only where there is unobstructed visibility of oncoming traffic in both directions.
- v) Work Area may or may not contain a Work Vehicle. See General Notes to Layouts #4. If Work Vehicle has a TC-12, it must be in bar mode.

For further detail on Work Zone components, see [Table A \(Mobile/Intermittent/Very Short, pg. 240\)](#).

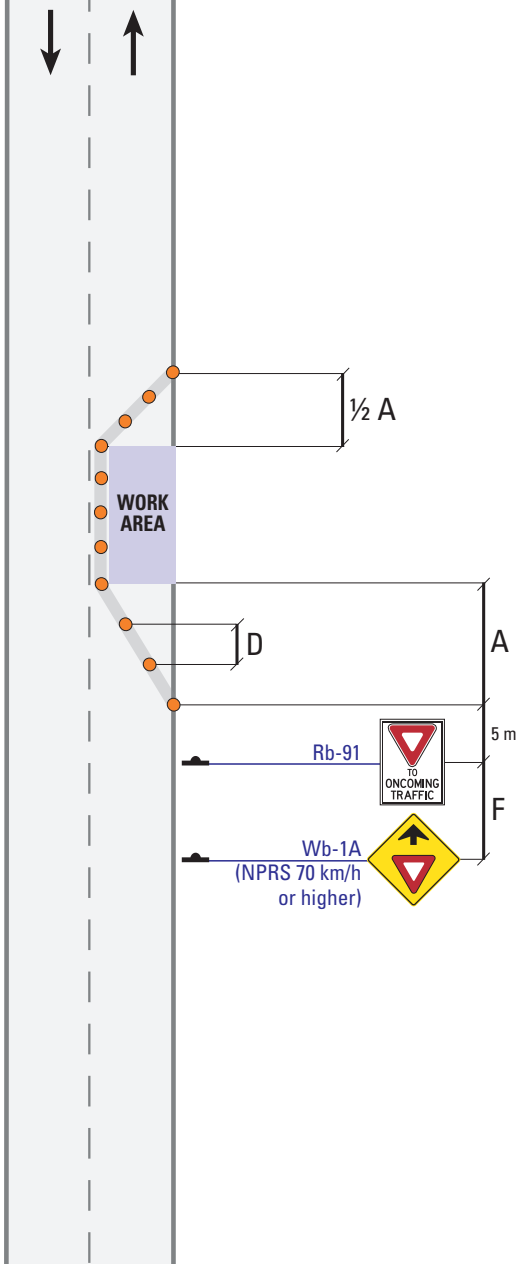

Label	Description	Normal Posted Regulatory Speed (km/h)				
		50	60	70	80	90
<b>A</b>	Taper Length for Full Lane Closure (m)	60	85	100	100	110
<b>D</b>	Maximum Distance between Markers (m)	6	6	9	9	12
	Minimum Number of Markers for Taper	4	5	5	7	8
<b>F</b>	Distance between Construction Signs (m)	30	30	60	60	80

**TS-18**

**Lane Closed (Yield to Oncoming Traffic) (Low Volume Roads)**

**Two-Lane, Two-Way**

Mobile Operations

Intermittent

Very Short Duration

**Short Duration**

Long Duration

**NOTES**

- i) Use only on roads with Low Traffic Volume (< 3000 vehicles per day).
- ii) To be used for short length Work Areas (<150 m).
- iii) May also be used on roads with no centreline.
- iv) Use only where there is unobstructed visibility of oncoming traffic in both directions.
- v) Work Area may or may not contain a Work Vehicle. See General Notes to Layouts #4. If Work Vehicle has a TC-12, it must be in bar mode.

For further detail on Work Zone components, see [Table B \(Short/Long, pg. 241\)](#).

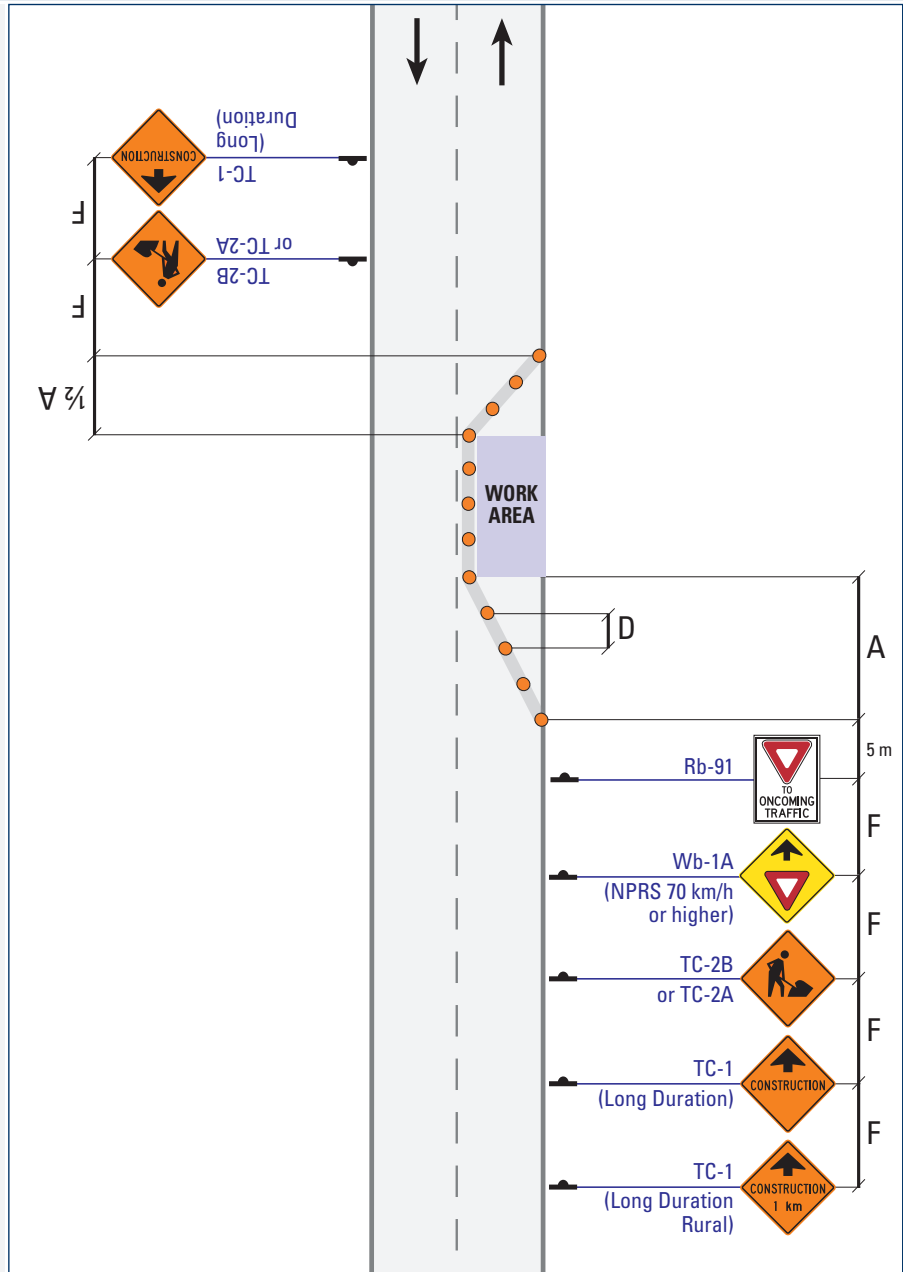

TWO-LANE TWO-WAY

Label	Description	Normal Posted Regulatory Speed (km/h)				
		50	60	70	80	90
<b>A</b>	Taper Length for Full Lane Closure (m)	60	85	155	180	200
<b>D</b>	Maximum Distance between Markers (m)	6	9	9	12	12
	Minimum Number of Markers for Taper	5	7	9	11	13
<b>F</b>	Distance between Construction Signs (m)	50	90	120	140	150



**TS-20 Lane Closed (Traffic Control Persons)**

**Two-Lane, Two-Way** Mobile Operations Intermittent Very Short Duration **Short Duration** Long Duration

**NOTES**

i) Centreline Markers between the Rb-25 signs are optional and may be used in one or both approaches if lane keeping becomes an issue. For projects on MTO highways, it is recommended to use Markers in both approaches.

For further detail on Work Zone components see [Table B \(Short/Long, pg. 241\)](#).

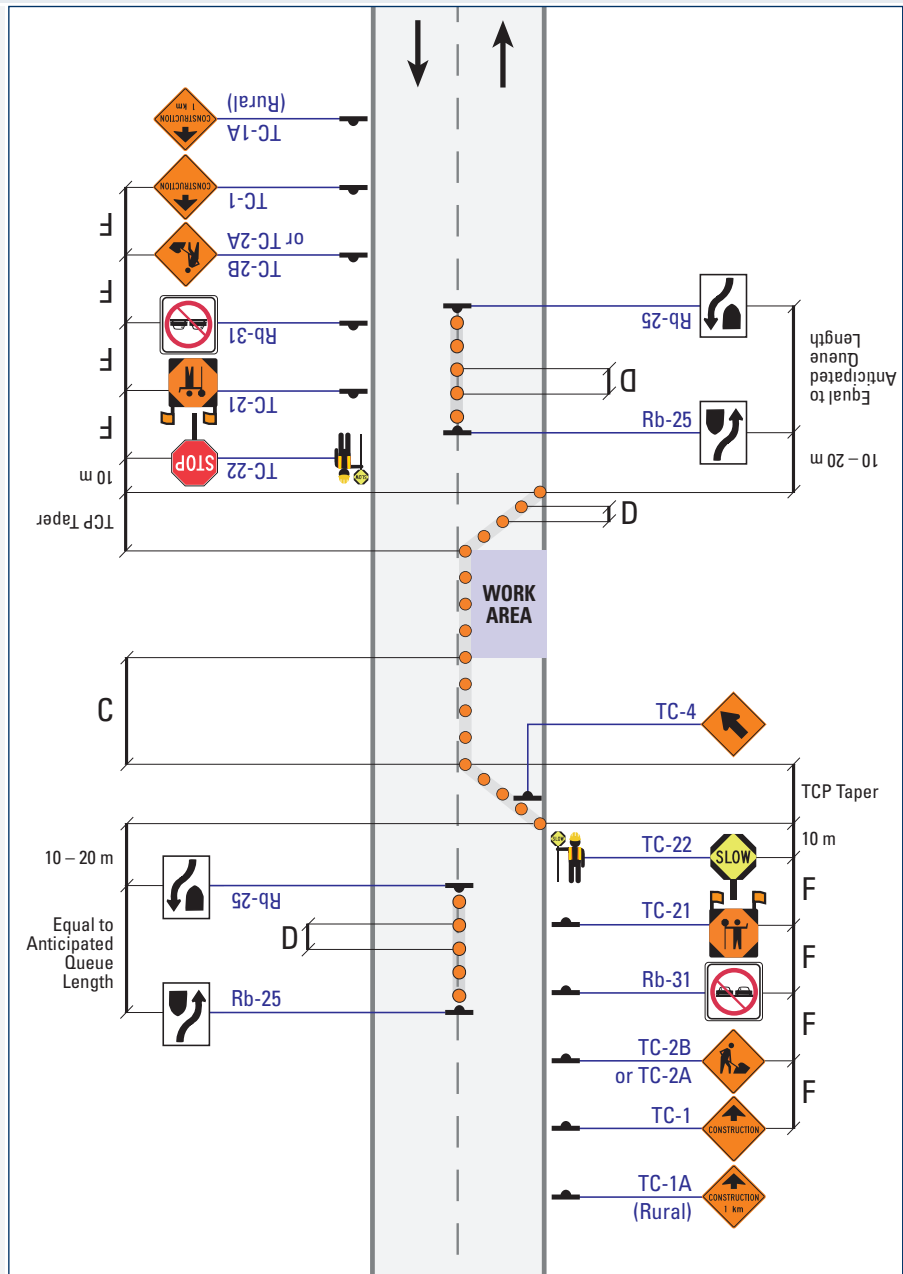

TWO-LANE TWO-WAY

Label	Description	Normal Posted Regulatory Speed (km/h)				
		50	60	70	80	90
<b>TCP</b>	Taper Length for TCP Presence (m)	15	20	25	30	30
<b>C</b>	Longitudinal Buffer Area (LBA) (m)	(30)	(40)	50	60	75
<b>D</b>	Maximum Distance between Markers (m)	6	9	9	12	12
	Minimum Number of Markers for Taper	5	7	9	11	13
<b>F</b>	Distance between Construction Signs (m)	50	90	120	140	150

**TS-21**      **Route Detour (Alternative Roads)**

**Two-Lane, Two-Way**    Mobile Operations    Intermittent    Very Short Duration    **Short Duration**    Long Duration

**NOTES**

- i) See TS-22 for Sign Details.
- ii) The same approach to signing is required in the opposite direction.
- iii) TC-54 can be used in place of TC-53A.

For further detail on Work Zone components, see [Table B \(Short/Long, pg. 241\)](#).

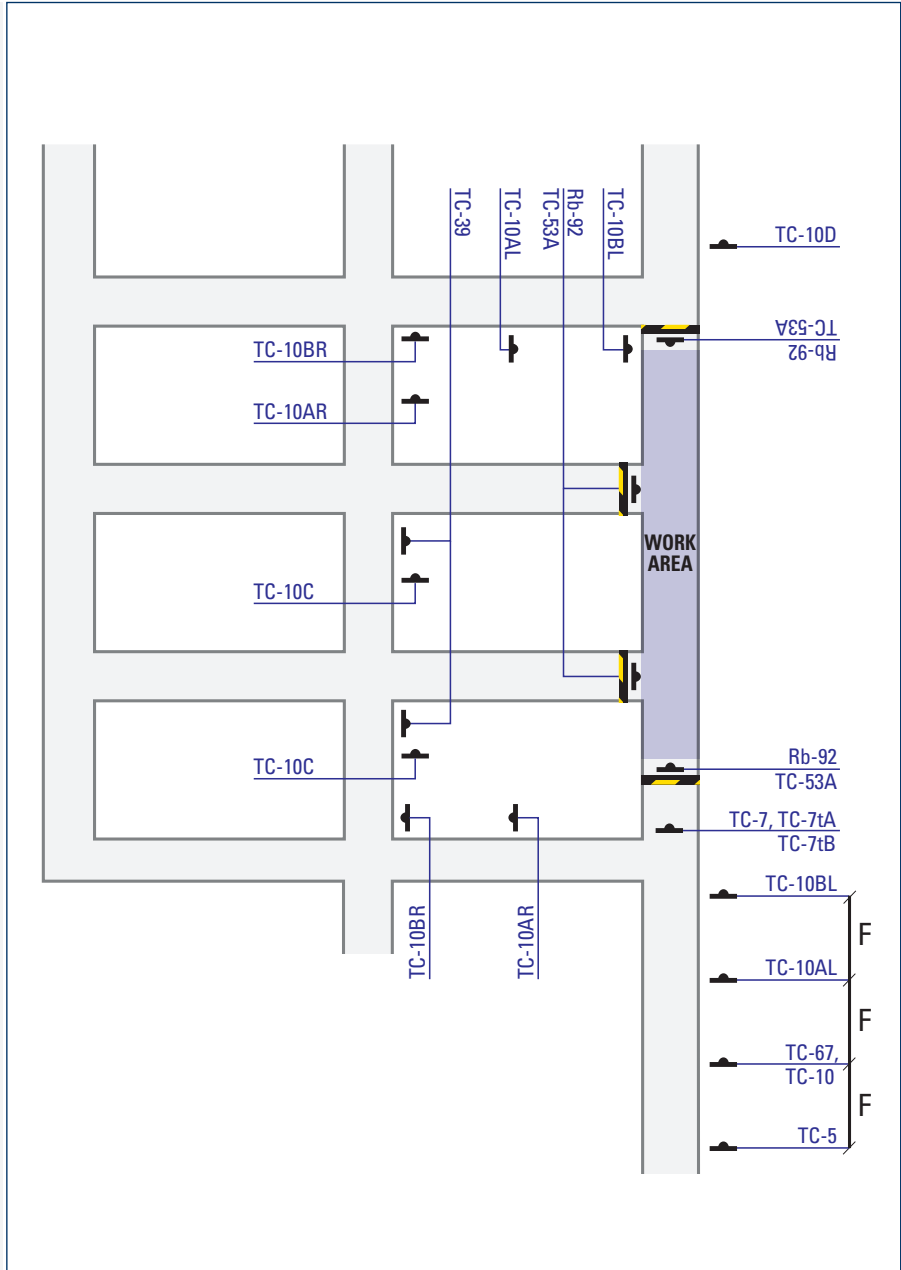

Label	Description	Normal Posted Regulatory Speed (km/h)				
		50	60	70	80	90
<b>F</b>	Distance between Construction Signs (m)	50	90	120	140	150



**TS-22**

**Detour Signs and Devices**

**Two-Lane, Two-Way**

Mobile Operations

Intermittent

Very Short Duration

**Short Duration**

Long Duration

**NOTES**

For further detail on Work Zone components, see [Table B \(Short/Long, pg. 241\)](#).

The following signs are to be used in the layout for Route Detour – see TS-21.



TC-10



TC-10AR

Other tabs may be used with the  sign as follows:



TC-10BR



TC-10C



TC-10ER



TC-10FR



TC-10AL



TC-10BL



TC-10D



TC-10EL



TC-10FL

Roundabout Fish-hook tabs:



TC-10BRr



TC-10ALr



TC-10Cr



TC-39



TC-5



Rb-92



TC-7

ROAD CLOSED  
LOCAL TRAFFIC ONLY

TC-7tA  
TC-7tB



TC-53A



TC-67

TC-10

TWO-LANE  
TWO-WAY



**TS-23**

**Pedestrian Detour: Sidewalk Closure**

**Two-Lane, Two-Way**

Mobile Operations

Intermittent

Very Short Duration

**Short Duration**

Long Duration

**NOTES**

i) TC-40L/R Pedestrian Direction sign must be placed at the nearest upstream controlled pedestrian crossing (traffic signal or Pedestrian Crossover) in each direction.

For further detail on Work Zone components, see [Table B \(Short/Long, pg. 241\)](#).

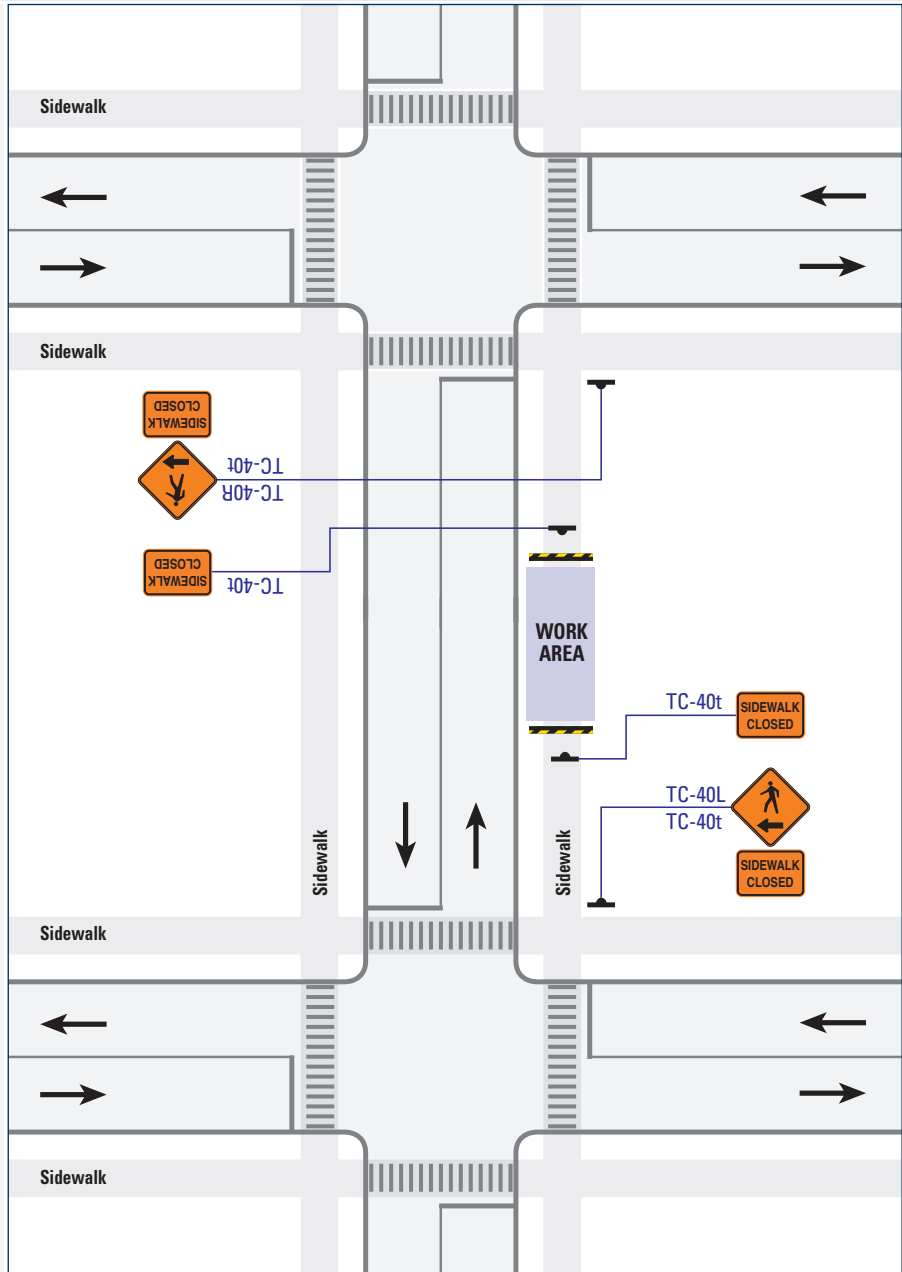

TWO-LANE  
TWO-WAY

**TS-24**

**Bicycle Lane Diversion: Bicycle Lane Shift**

**Two-Lane, Two-Way**

Mobile Operations

Intermittent

Very Short Duration

**Short Duration**

Long Duration

**NOTES**

i) If space permits, TC-54 should be used in place of TC-51.

ii) AODA-compliant ramps are required if the curb is raised.

For further detail on Work Zone components, see [Table B \(Short/Long, pg. 241\)](#).

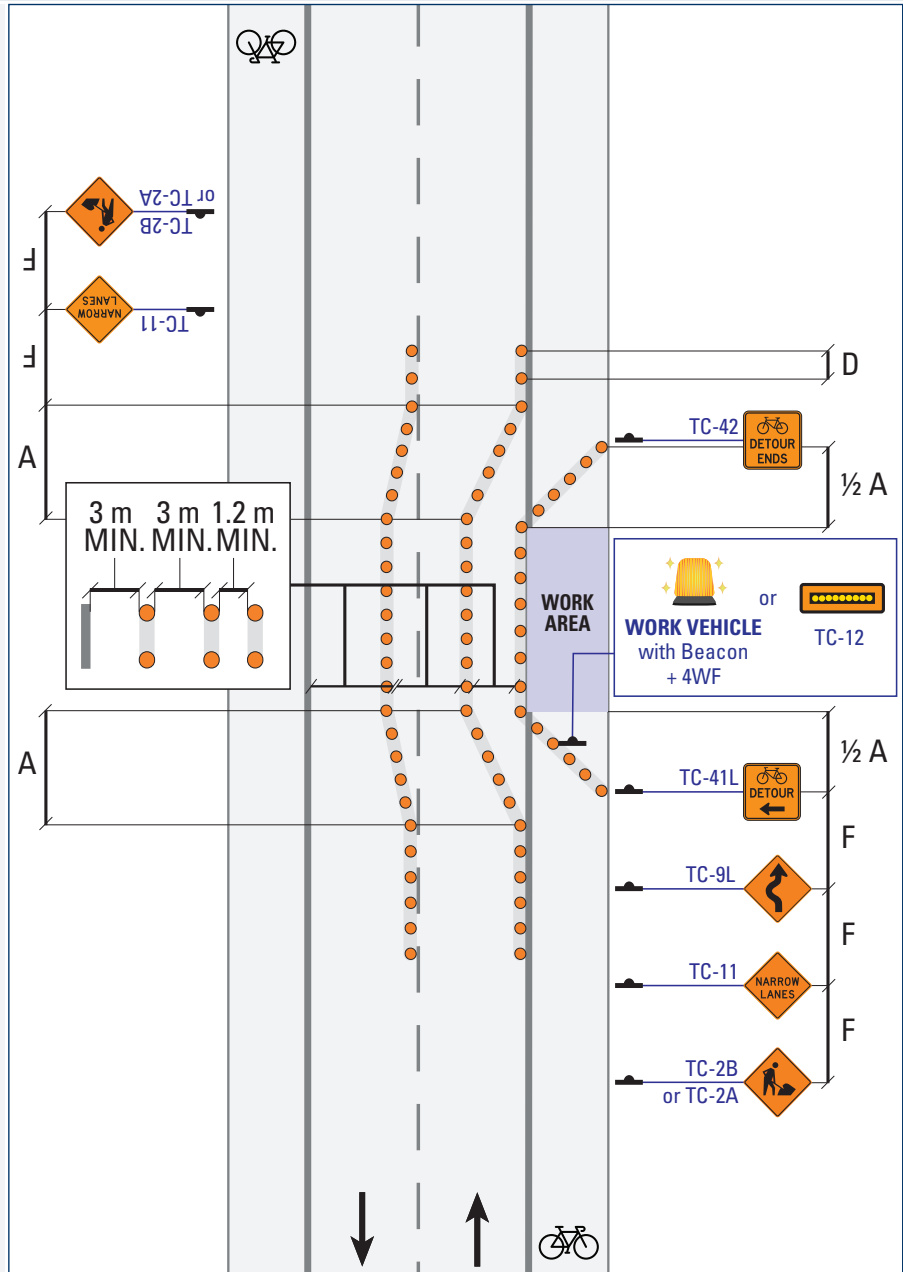

TWO-LANE  
TWO-WAY

Label	Description	Normal Posted Regulatory Speed (km/h)				
		50	60	70	80	90
<b>A</b>	Taper Length for Full Lane Closure (m)	60	85	155	180	200
<b>D</b>	Maximum Distance between Markers (m)	6	9	9	12	12
	Minimum Number of Markers for Taper	5	7	9	11	13
<b>F</b>	Distance between Construction Signs (m)	50	90	120	140	150

**TS-25**

**Bicycle Lane Diversion: Bicycle Lane Shift**

**Two-Lane, Two-Way**

Mobile Operations

Intermittent

Very Short Duration

Short Duration

Long Duration

**NOTES**

- i) If space permits, TC-54 should be used in place of TC-51.
- ii) AODA-compliant ramps are required if the curb is raised.

For further detail on Work Zone components, see [Table B \(Short/Long, pg. 241\)](#).

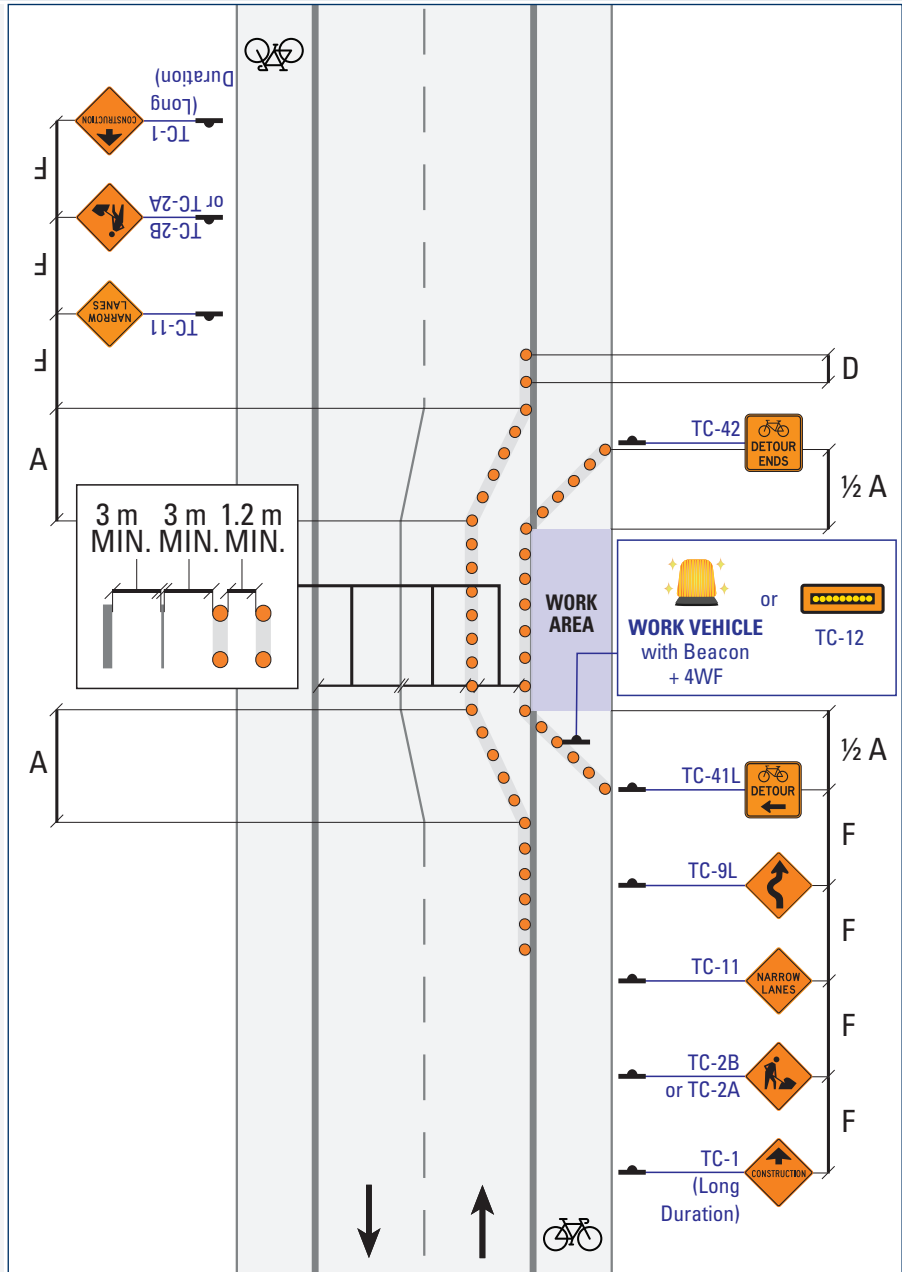

**Normal Posted Regulatory Speed (km/h)**

Label	Description	50	60	70	80	90
<b>A</b>	Taper Length for Full Lane Closure (m)	60	85	155	180	200
<b>D</b>	Maximum Distance between Markers (m)	6	9	9	12	12
	Minimum Number of Markers for Taper	5	7	9	11	13
<b>F</b>	Distance between Construction Signs (m)	50	90	120	140	150

TWO-LANE  
TWO-WAY

**TS-26**

**Bicycle Lane Diversion: Temporary Path**

Two-Lane, Two-Way

Mobile Operations

Intermittent

Very Short Duration

Short Duration

Long Duration

**NOTES**

For further detail on Work Zone components, see [Table B \(Short/Long, pg. 241\)](#).

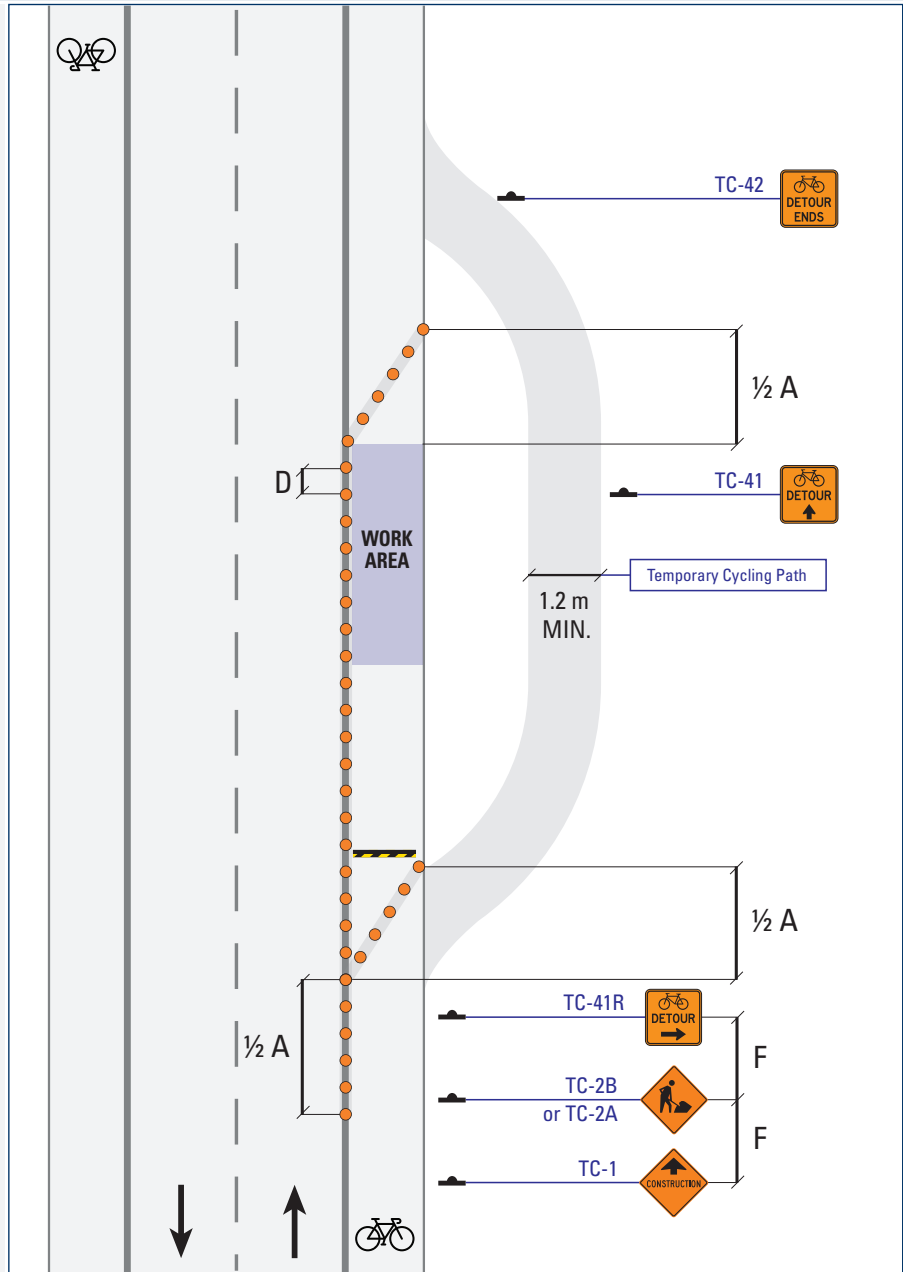

TWO-LANE TWO-WAY

Label	Description	Normal Posted Regulatory Speed (km/h)				
		50	60	70	80	90
<b>A</b>	Taper Length for Full Lane Closure (m)	60	85	155	180	200
<b>D</b>	Maximum Distance between Markers (m)	6	9	9	12	12
	Minimum Number of Markers for Taper	5	7	9	11	13
<b>F</b>	Distance between Construction Signs (m)	50	90	120	140	150

**TS-27 Bicycle Lane Diversion: Single File**

Two-Lane, Two-Way    Mobile Operations    Intermittent    Very Short Duration    Short Duration    Long Duration

**NOTES**

i) AODA-compliant ramps are required if the curb is raised.

ii) Ensure signage is visible for drivers to be aware of merging cyclists.

**Shared lane only to be used if considered by OTM Book 18 or MTO Bikeways Design Manual, Desirable Cycling Facility Nomograph. Otherwise, cycling Detour should be provided.**

For further detail on Work Zone components, see [Table B \(Short/Long, pg. 241\)](#).

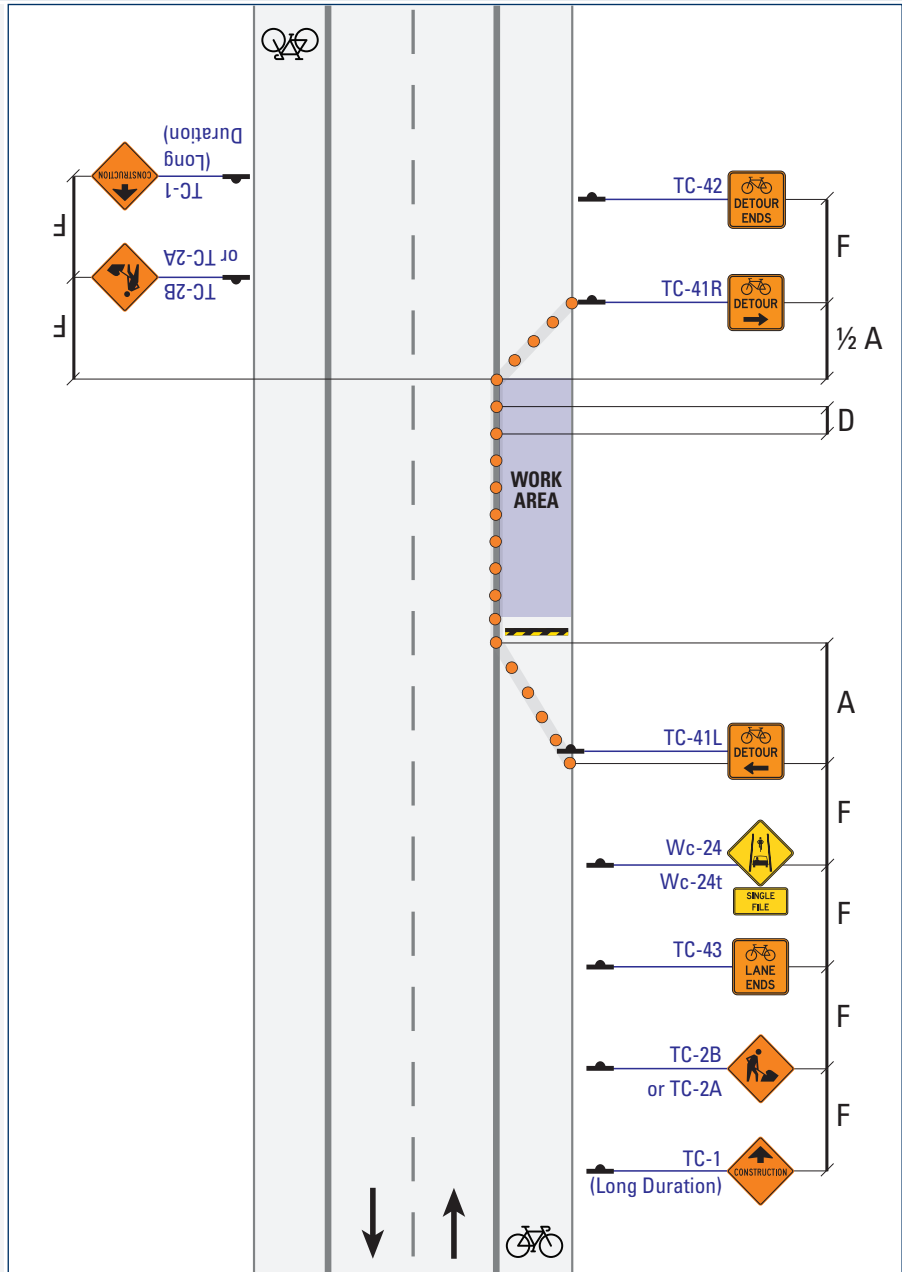

**Normal Posted Regulatory Speed (km/h)**

Label	Description	50	60	70	80	90
<b>A</b>	Taper Length for Full Lane Closure (m)	60	85	155	180	200
<b>D</b>	Maximum Distance between Markers (m)	6	9	9	12	12
	Minimum Number of Markers for Taper	5	7	9	11	13
<b>F</b>	Distance between Construction Signs (m)	50	90	120	140	150



**TI-1**

**Intermittent Work: Intersection**

**Two-Lane, Two-Way**

Mobile Operations

**Intermittent**

Very Short Duration

Short Duration

Long Duration

**NOTES**

- i) Any equipment or Work Vehicles that continuously occupy the shoulder should comply with TS-1.
- ii) When Traffic Volumes are High or when the intersection is signalized, consult the Road Authority to determine whether police assistance is required.

**Where a worker is moving within the Intermittent Work Area with only brief stationary moments, for example, pothole patching:**

- Worker requires sight distance (refer to H in Table).
- Spotter(s) required when sight distance is not available.
- Where clear and constant verbal communication is not possible (i.e., distance, noise), spotter(s) and worker must use two-way communication devices.
- Where required sight distances (refer to H in Table) are present and the worker/technician's activities permit a continuous consciousness of approaching traffic, a spotter may not be required.
- Worker must not interfere with traffic.

**Note:** this would allow for a single worker operation (i.e., surveyor or possibly one-person pothole repair).

For further detail on Work Zone components, see [Table A \(Mobile/Intermittent/Very Short, pg. 240\)](#).

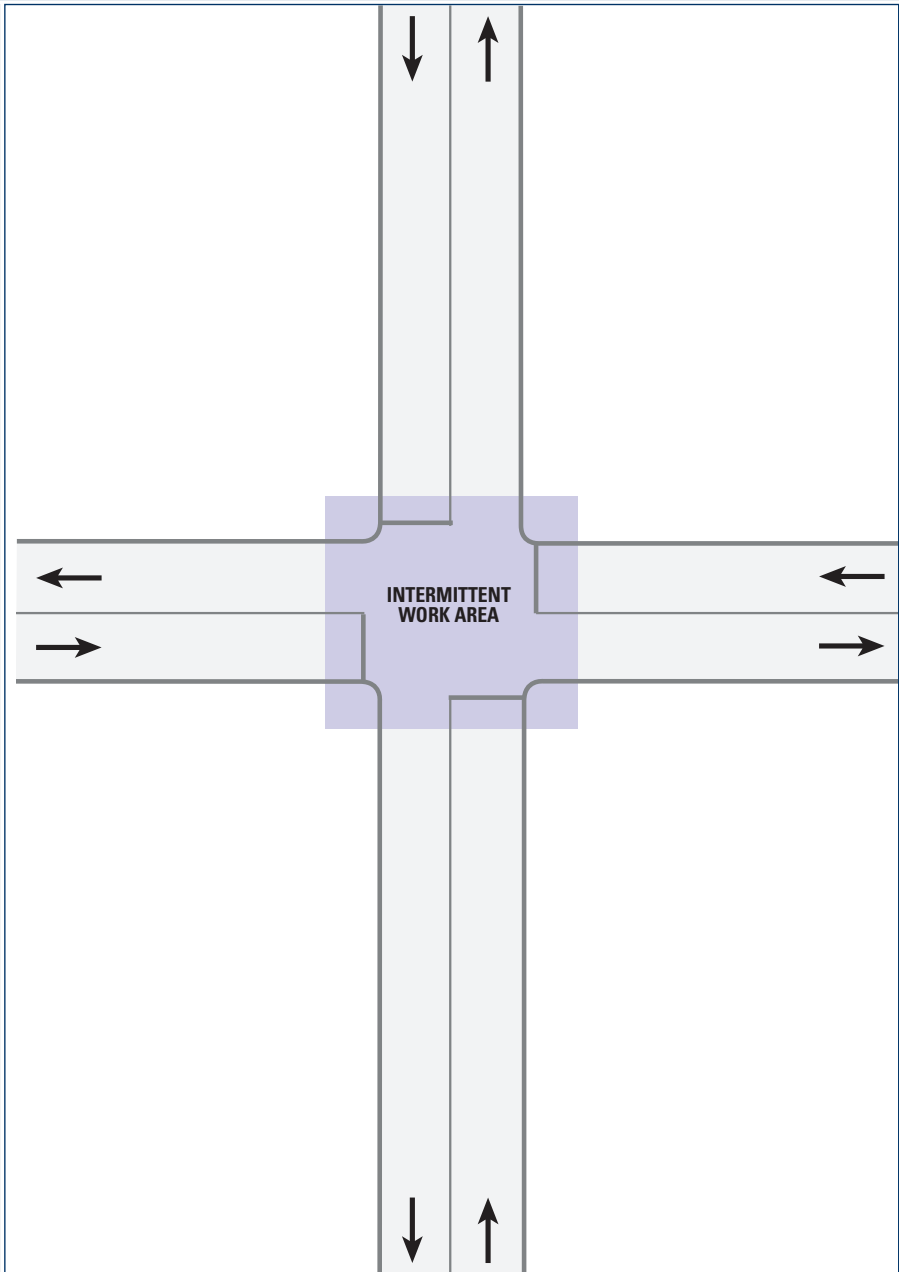

TWO-LANE TWO-WAY

**Normal Posted Regulatory Speed (km/h)**

Label	Description	Normal Posted Regulatory Speed (km/h)				
		50	60	70	80	90
<b>H</b>	Sight Distance (m)	150	150	200	250	250

**TI-2 Intermittent Work: Intersection**

Two-Lane, Two-Way    Mobile Operations    Intermittent    **Very Short Duration**    Short Duration    Long Duration

**NOTES**

- i) Any equipment or Work Vehicles that continuously occupy the shoulder should comply with TS-2.
- ii) When Traffic Volumes are High or when the intersection is signalized, consult the Road Authority to determine whether police assistance is required.

**Where a worker is moving within the Intermittent Work Area with only brief stationary moments, for example, pothole patching:**

- Worker requires sight distance (refer to H in Table).
- Spotter(s) required when sight distance is not available.
- Where clear and constant verbal communication is not possible (i.e., distance, noise), spotter(s) and worker must use two-way communication devices.
- Where required sight distances (refer to H in Table) are present and the worker/technician's activities permit a continuous consciousness of approaching traffic, a spotter may not be required.
- Worker must not interfere with traffic.

**Note:** this would allow for a single worker operation (i.e., surveyor or possibly one-person pothole repair).

For further detail on Work Zone components, see [Table A \(Mobile/Intermittent/Very Short, pg. 240\)](#).

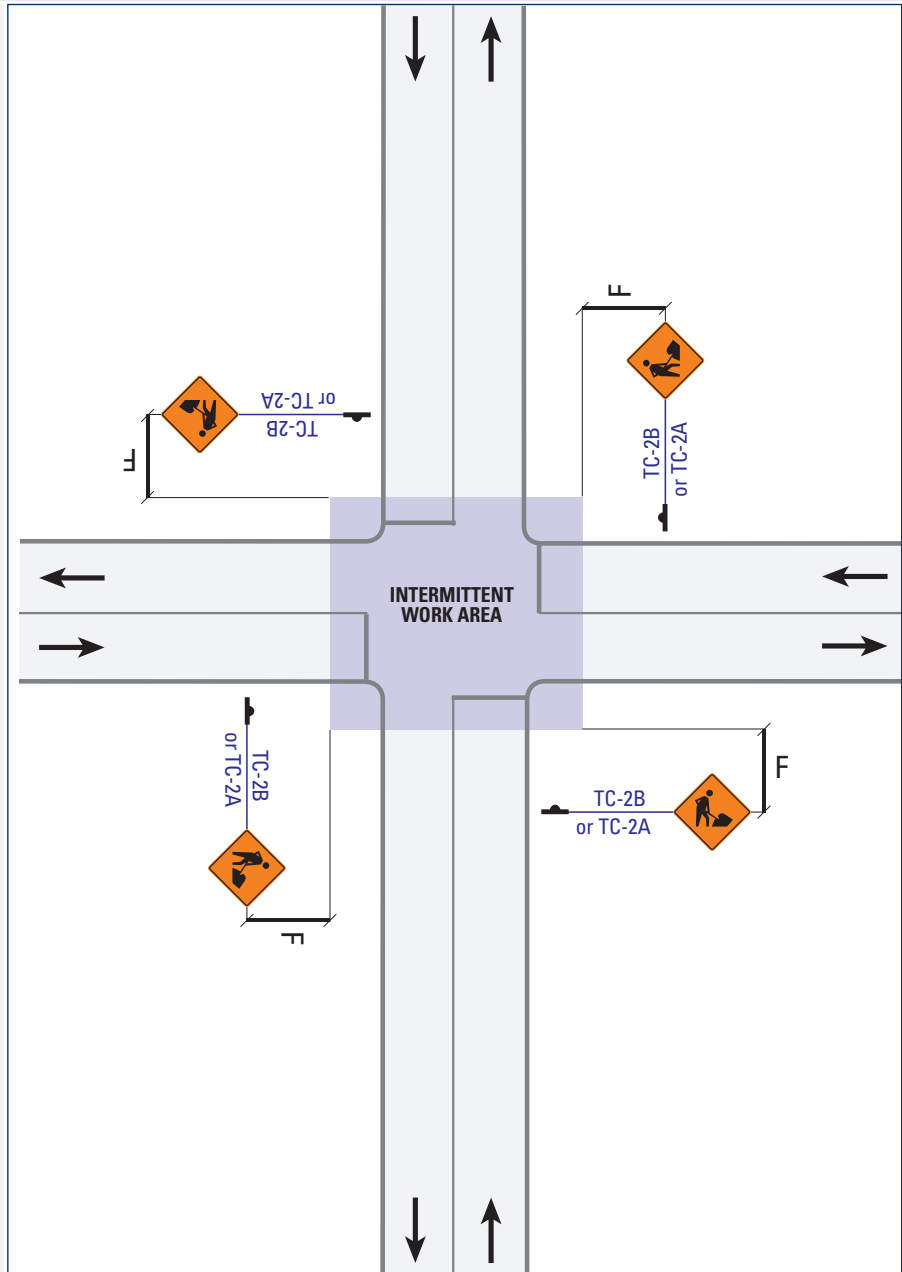

Label	Description	Normal Posted Regulatory Speed (km/h)				
		50	60	70	80	90
<b>F</b>	Distance between Construction Signs (m)	30	30	60	60	80
<b>H</b>	Sight Distance (m)	150	150	200	250	250



**TI-3 Intermittent Work: Intersection**

**Two-Lane, Two-Way** Mobile Operations Intermittent Very Short Duration **Short Duration** Long Duration

**NOTES**

- i) Any equipment or Work Vehicles that continuously occupy the shoulder should comply with TS-3.
- ii) When Traffic Volumes are High or when the intersection is signalized, consult the Road Authority to determine whether police assistance is required.

**Where a worker is moving within the Intermittent Work Area with only brief stationary moments, for example, pothole patching:**

- Worker requires sight distance (refer to H in Table).
- Spotter(s) required when sight distance is not available.
- Where clear and constant verbal communication is not possible (i.e., distance, noise), spotter(s) and worker must use two-way communication devices.
- Where required sight distances (refer to H in Table) are present and the worker/technician's activities permit a continuous consciousness of approaching traffic, a spotter may not be required.
- Worker must not interfere with traffic.

**Note:** this would allow for a single worker operation (i.e., surveyor or possibly one-person pothole repair).

For further detail on Work Zone components, see [Table B \(Short/Long, pg. 241\)](#).

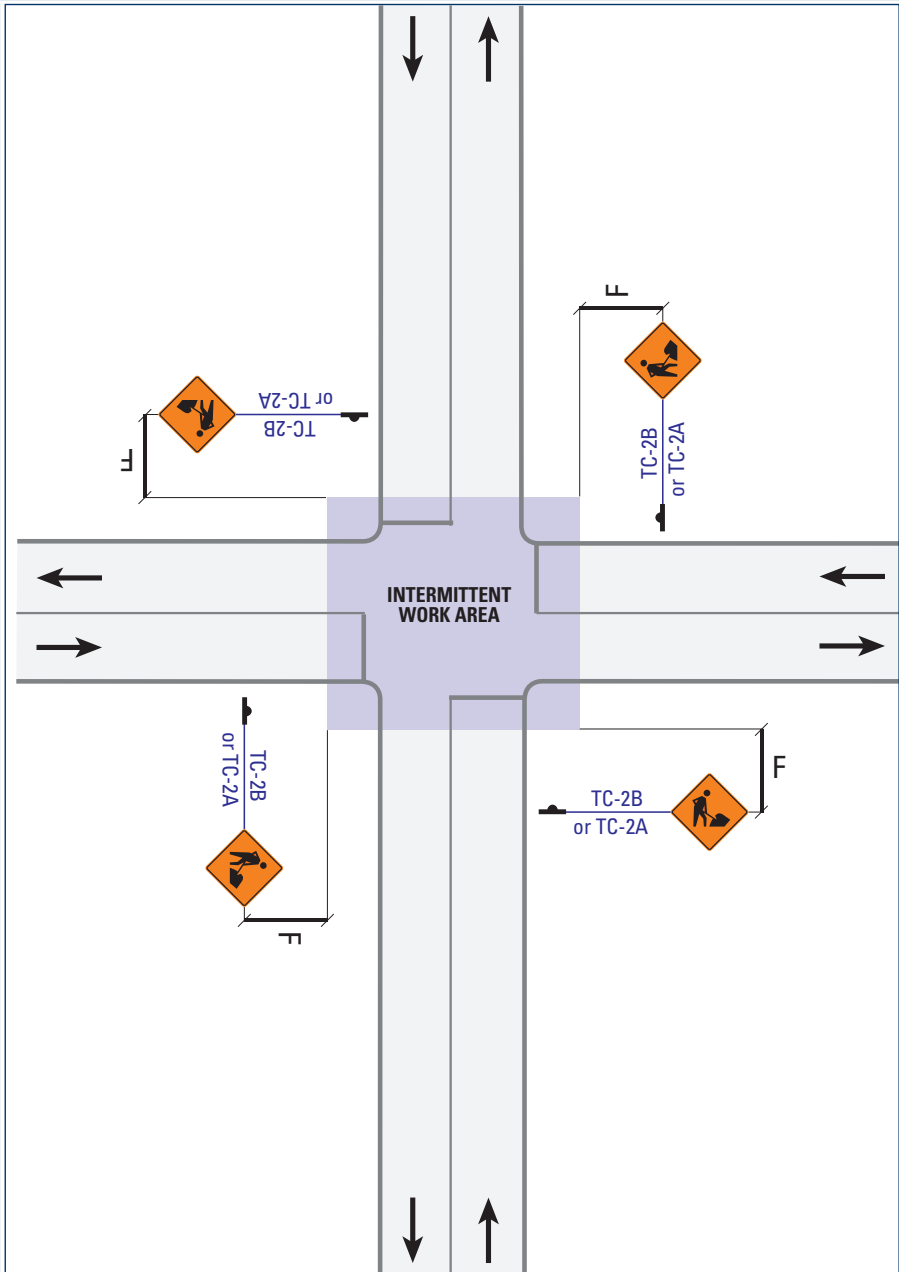

TWO-LANE TWO-WAY

Label	Description	Normal Posted Regulatory Speed (km/h)				
		50	60	70	80	90
<b>F</b>	Distance between Construction Signs (m)	50	90	120	140	150
<b>H</b>	Sight Distance (m)	150	150	200	250	250



**TI-4 Zone Painting: Intersection Turn Arrows**

**Two-Lane, Two-Way**

Mobile Operations

Intermittent

**Very Short Duration**

Short Duration

Long Duration

**NOTES**

i) Centreline Delineation required if workers present.

For further detail on Work Zone components, see [Table A \(Mobile/Intermittent/Very Short, pg. 240\)](#).

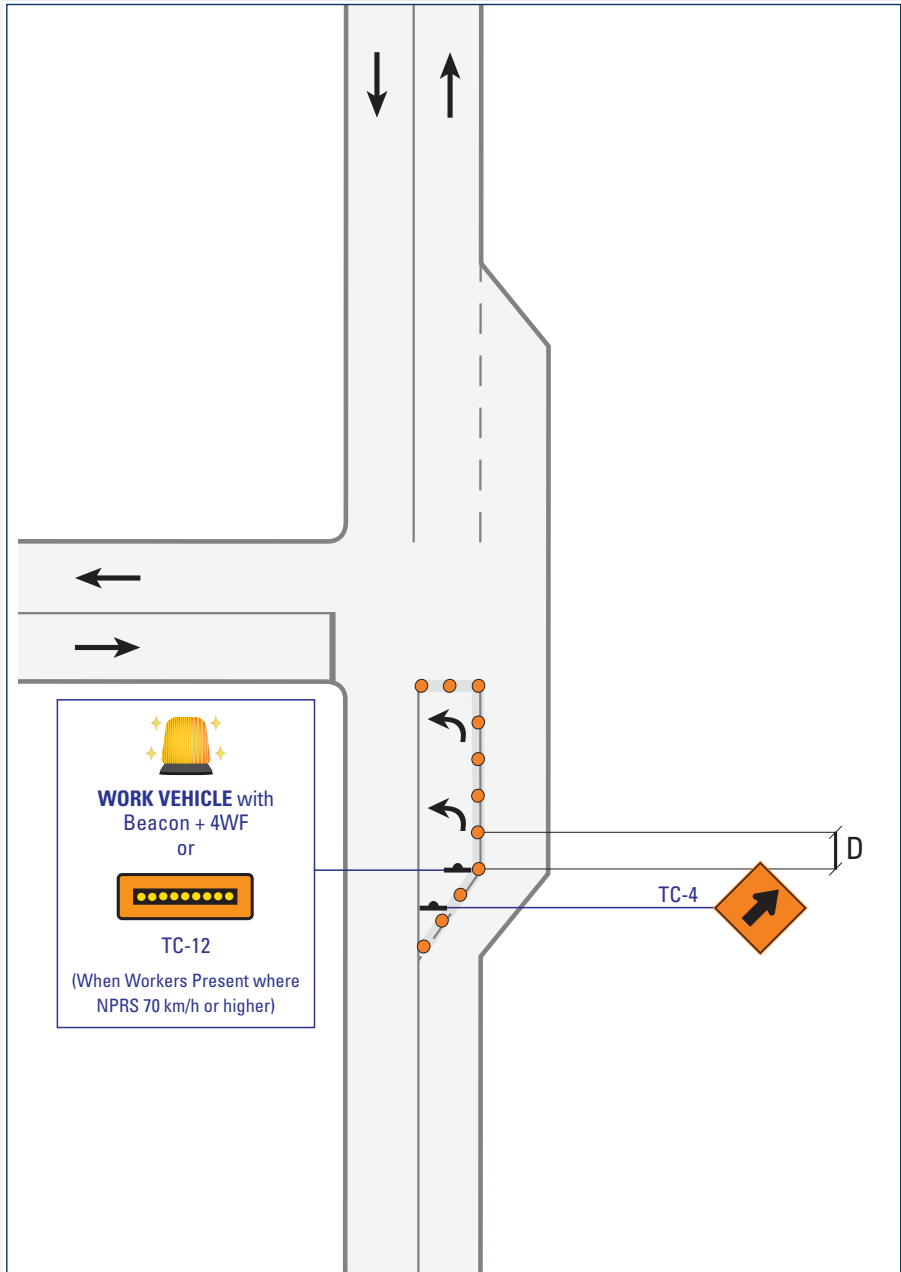

Label	Description	Normal Posted Regulatory Speed (km/h)				
		50	60	70	80	90
<b>D</b>	Maximum Distance between Markers (m)	6	6	9	9	12
	Minimum Number of Markers for Taper	4	5	5	7	8

**TI-5 Zone Painting: Intersection Turn Arrows**

**Two-Lane, Two-Way**

Mobile Operations

Intermittent

Very Short Duration

**Short Duration**

Long Duration

**NOTES**

i) Centreline Delineation required if workers present.

For further detail on Work Zone components, see [Table B \(Short/Long, pg. 241\)](#).

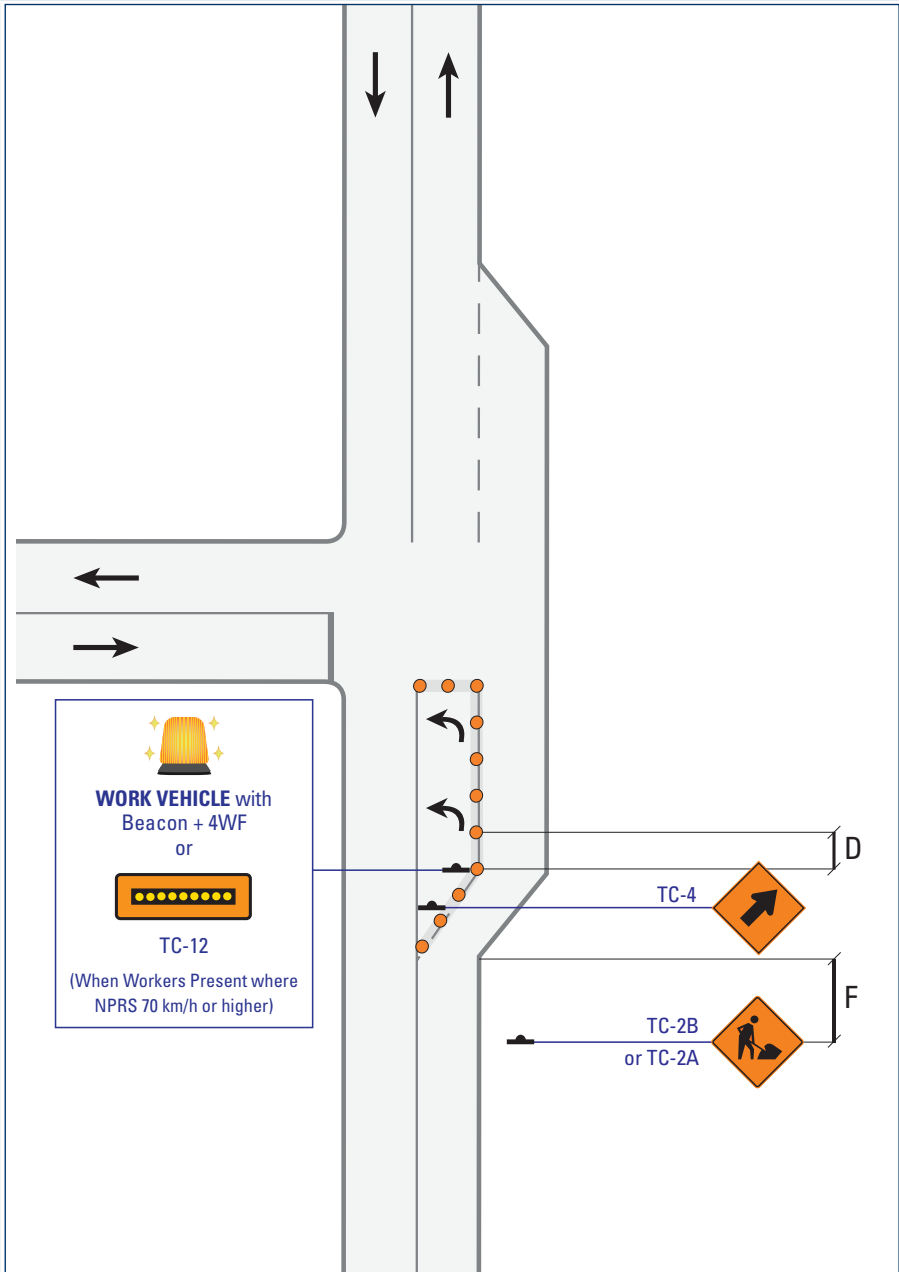

Label	Description	Normal Posted Regulatory Speed (km/h)				
		50	60	70	80	90
<b>D</b>	Maximum Distance between Markers (m)	6	9	9	12	12
	Minimum Number of Markers for Taper	5	7	9	11	13
<b>F</b>	Distance between Construction Signs (m)	50	90	120	140	150

**TI-6 Zone Painting: Intersection Stoplines and Crosswalks**

**Two-Lane, Two-Way**

Mobile Operations

Intermittent

**Very Short Duration**

Short Duration

Long Duration

**NOTES**

- i) Use only on highways with Low Traffic Volume (<3000 vehicles per day) and low speed (<70 km/h).
- ii) It may be necessary to paint the stop line and crosswalks in sections to maintain traffic flow.

For further detail on Work Zone components, see [Table A \(Mobile/Intermittent/Very Short, pg. 240\)](#).

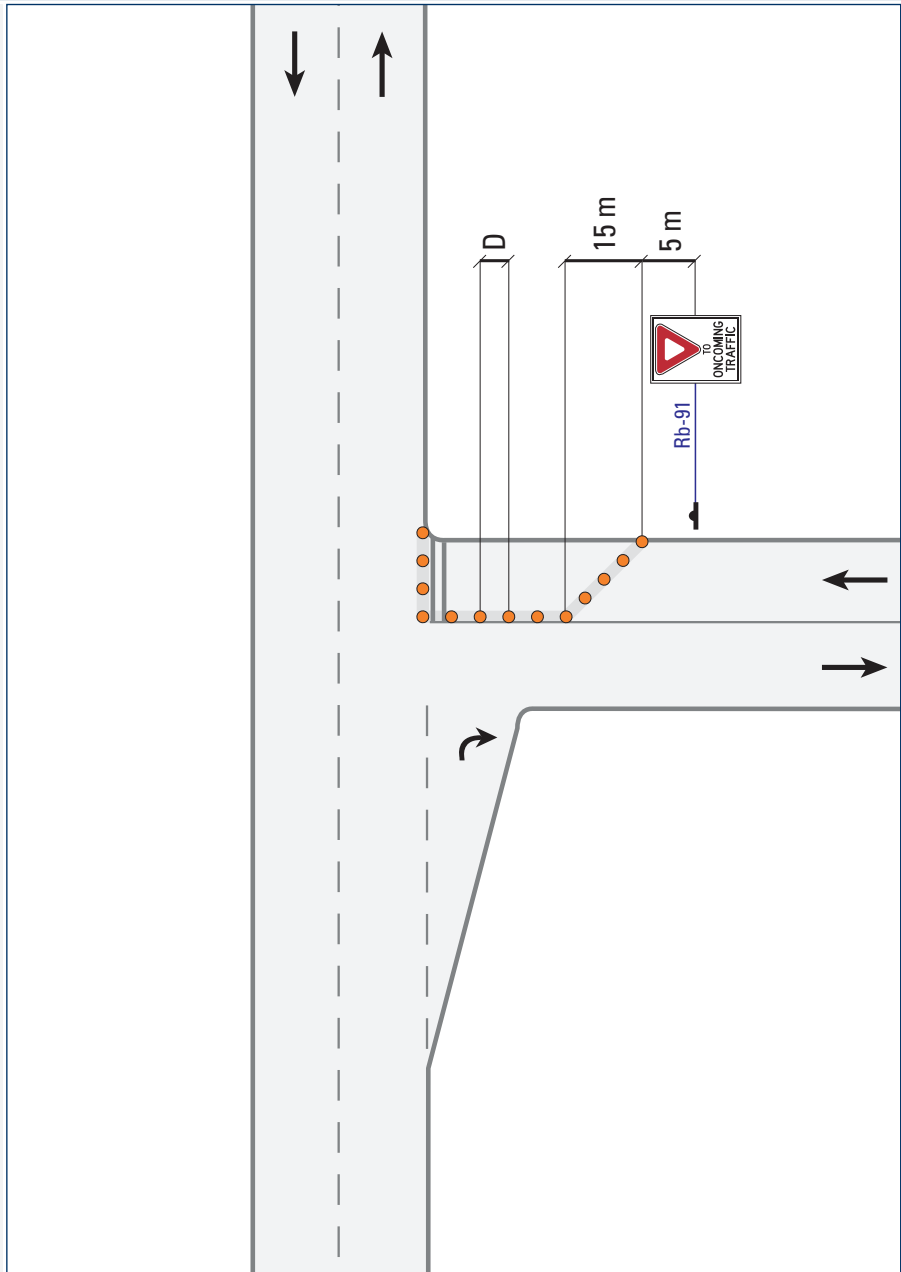

Label	Description	Normal Posted Regulatory Speed (km/h)		
		50	60	70
<b>D</b>	Maximum Distance between Markers (m)	6	6	9
	Minimum Number of Markers for Taper	4	5	5

TWO-LANE  
TWO-WAY

**TI-7**

**Zone Painting: Intersection Stoplines and Crosswalks**

**Two-Lane, Two-Way**

Mobile Operations

Intermittent

Very Short Duration

**Short Duration**

Long Duration

**NOTES**

i) Use only on highways with Low Traffic Volume (<3000 vehicles per day) and low speed (<70 km/h).

ii) It may be necessary to paint the stop line and crosswalks in sections to maintain traffic flow.

For further detail on Work Zone components, see [Table B \(Short/Long, pg. 241\)](#).

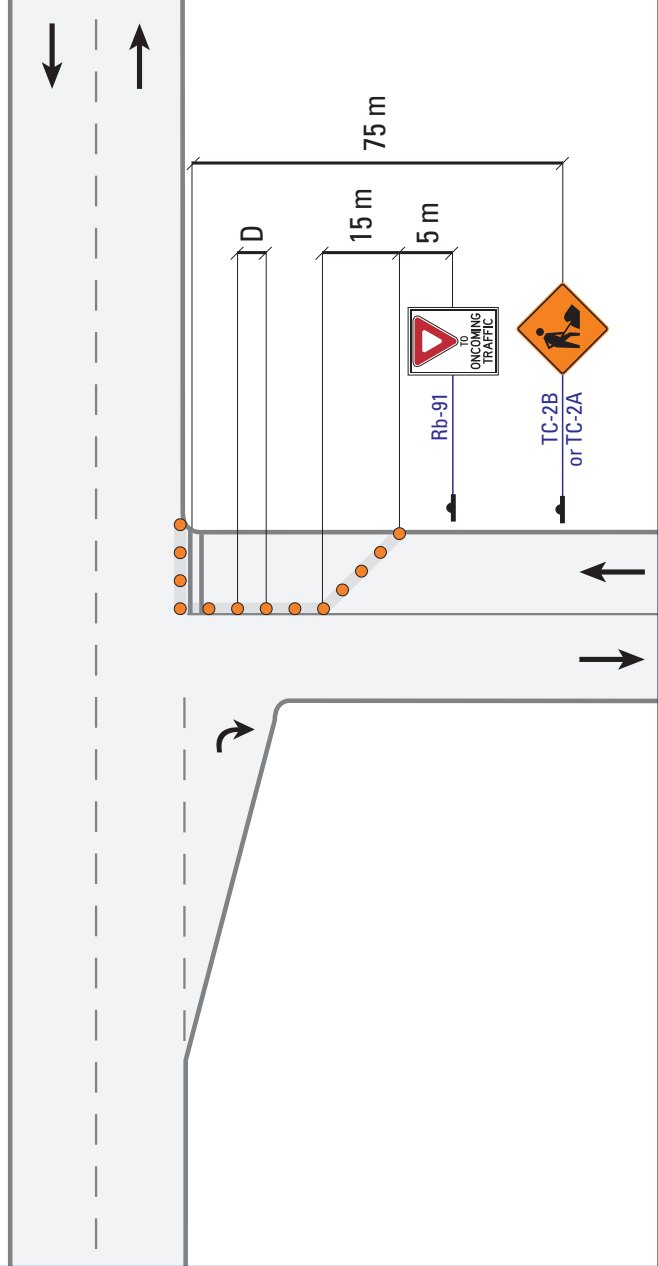

TWO-LANE  
TWO-WAY

Label	Description	Normal Posted Regulatory Speed (km/h)		
		50	60	70
<b>D</b>	Maximum Distance between Markers (m)	6	9	9
	Minimum Number of Markers for Taper	5	7	9

**TI-8 Intersection: Near-Side Lane Closed (TCP)**

**Two-Lane, Two-Way**

Mobile Operations

Intermittent

**Very Short Duration**

Short Duration

Long Duration

**NOTES**

i) For Remote Control Device, see TS-19 as an example but this layout will need to be modified for the appropriate duration and highway configuration.

ii) When Traffic Volumes are High or when the intersection is signalized, consult the Road Authority to determine whether police assistance is required. Care should be taken by the TCP to coordinate with any intersection control such as traffic signals or STOP signs.

For further detail on Work Zone components see [Table A \(Mobile/Intermittent/Very Short, pg. 240\)](#), and [TCP Table \(pg. 175\)](#).

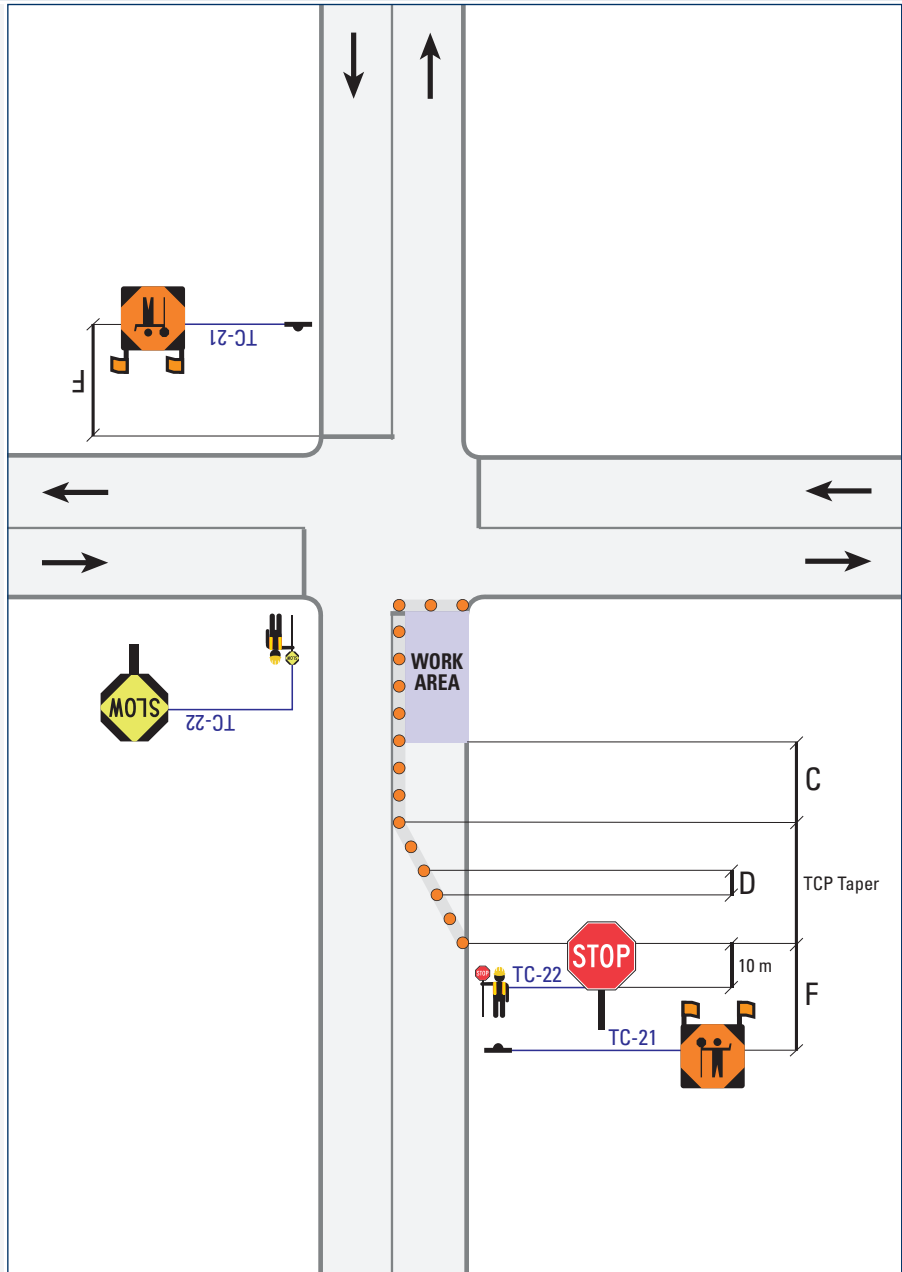

Label	Description	Normal Posted Regulatory Speed (km/h)				
		50	60	70	80	90
<b>TCP</b>	Taper Length for TCP Presence (m)	15	20	25	30	30
<b>C</b>	Longitudinal Buffer Area (LBA) (m)	(30)	(40)	50	60	75
<b>D</b>	Maximum Distance between Markers (m)	6	6	9	9	12
	Minimum Number of Markers for Taper	4	5	5	7	8
<b>F</b>	Distance between Construction Signs (m)	30	30	60	60	80

**TI-9 Intersection: Near-Side Lane Closed (TCP)**

**Two-Lane, Two-Way** Mobile Operations Intermittent Very Short Duration **Short Duration** Long Duration

**NOTES**

i) For Remote Control Device, see TS-19 as an example but this layout will need to be modified for the appropriate duration and highway configuration.

ii) When Traffic Volumes are High or when the intersection is signalized, consult the Road Authority to determine whether police assistance is required. Care should be taken by the TCP to coordinate with any intersection control such as traffic signals or STOP signs.

For further detail on Work Zone components see [Table B \(Short/Long, pg. 241\)](#), and [TCP Table \(pg. 175\)](#).

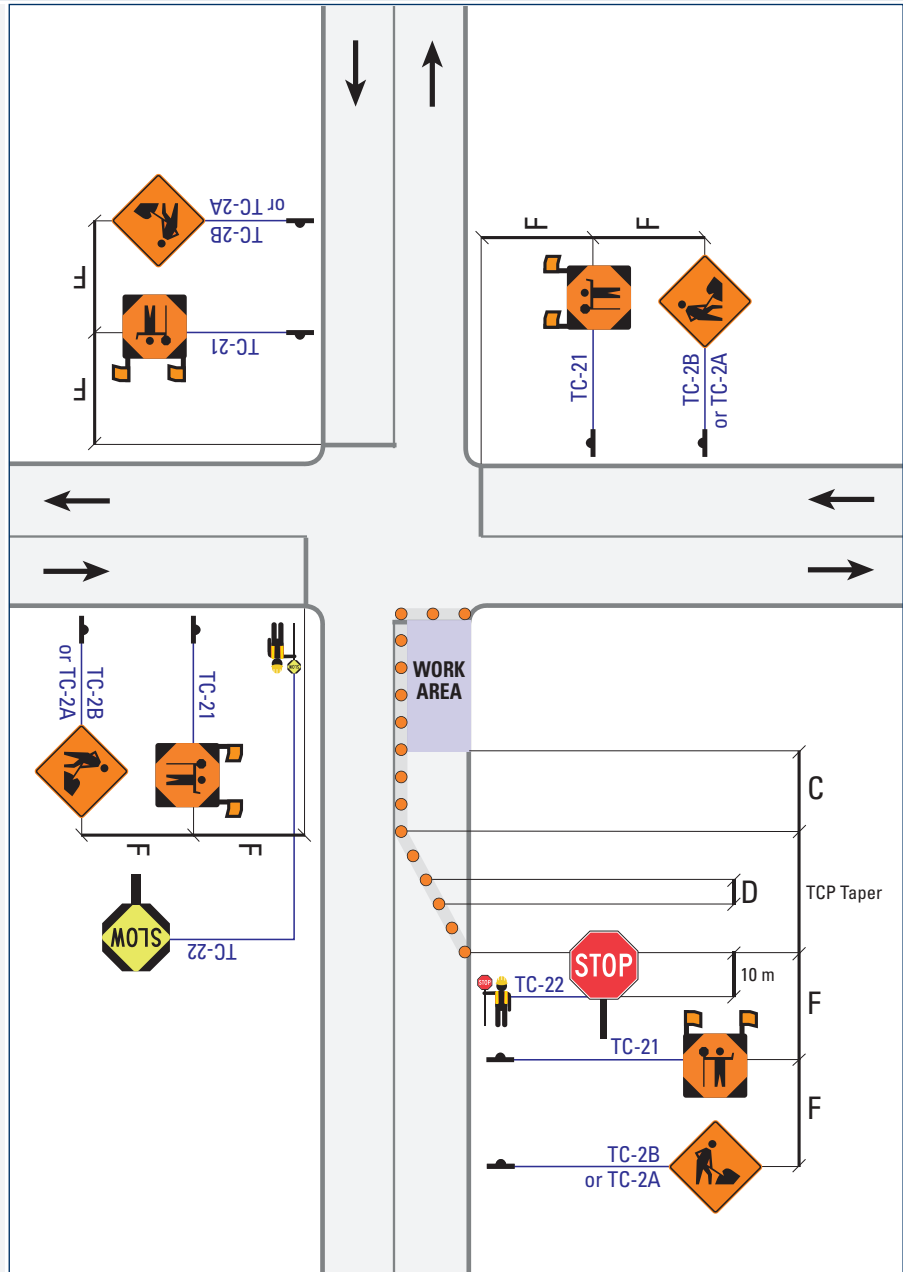

TWO-LANE  
TWO-WAY

Label	Description	Normal Posted Regulatory Speed (km/h)				
		50	60	70	80	90
<b>TCP</b>	Taper Length for TCP Presence (m)	15	20	25	30	30
<b>C</b>	Longitudinal Buffer Area (LBA) (m)	(30)	(40)	50	60	75
<b>D</b>	Maximum Distance between Markers (m)	6	9	9	12	12
	Minimum Number of Markers for Taper	5	7	9	11	13
<b>F</b>	Distance between Construction Signs (m)	50	90	120	140	150

**TI-10 Intersection: Far-Side Lane Closed (TCP)**

**Two-Lane, Two-Way**

Mobile Operations

Intermittent

**Very Short Duration**

Short Duration

Long Duration

**NOTES**

i) For Remote Control Device, see TS-19 as an example but this layout will need to be modified for the appropriate duration and highway configuration.

ii) When Traffic Volumes are High or when the intersection is signalized, consult the Road Authority to determine whether police assistance is required. Care should be taken by the TCP to coordinate with any intersection control such as traffic signals or STOP signs.

For further detail on Work Zone components, see [Table A \(Mobile/Intermittent/Very Short, pg. 240\)](#).

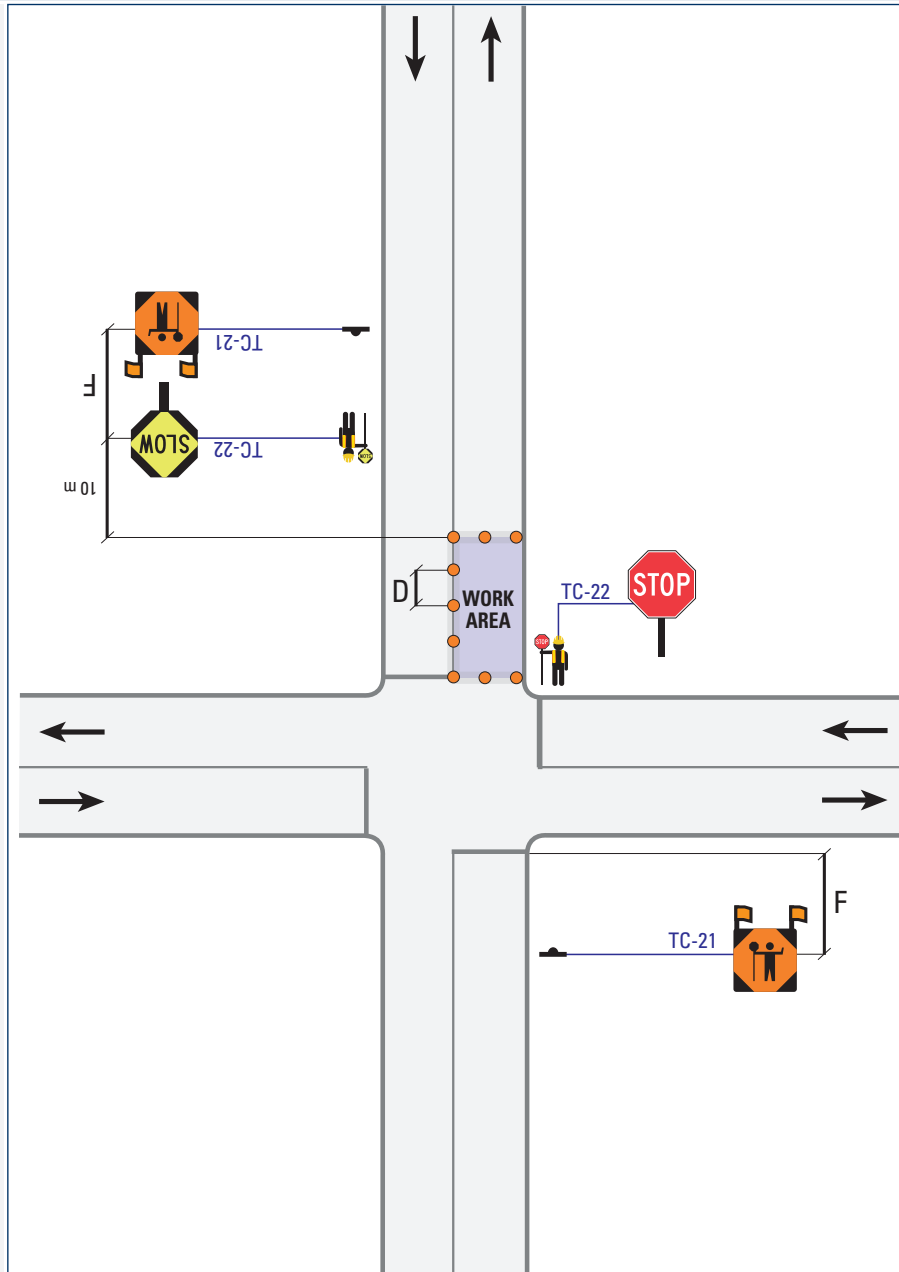

**Normal Posted Regulatory Speed (km/h)**

Label	Description	50	60	70	80	90
<b>D</b>	Maximum Distance between Markers (m)	6	6	9	9	12
<b>F</b>	Distance between Construction Signs (m)	30	30	60	60	80

**TI-11**

**Intersection: Far-Side Lane Closed (TCP)**

**Two-Lane, Two-Way**

Mobile Operations

Intermittent

Very Short Duration

**Short Duration**

Long Duration

**NOTES**

i) For Remote Control Device, see TS-19 as an example but this layout will need to be modified for the appropriate duration and highway configuration.

ii) When Traffic Volumes are High or when the intersection is signalized, consult the Road Authority to determine whether police assistance is required. Care should be taken by the TCP to coordinate with any intersection control such as traffic signals or STOP signs.

For further detail on Work Zone components, see [Table B \(Short/Long, pg. 241\)](#).

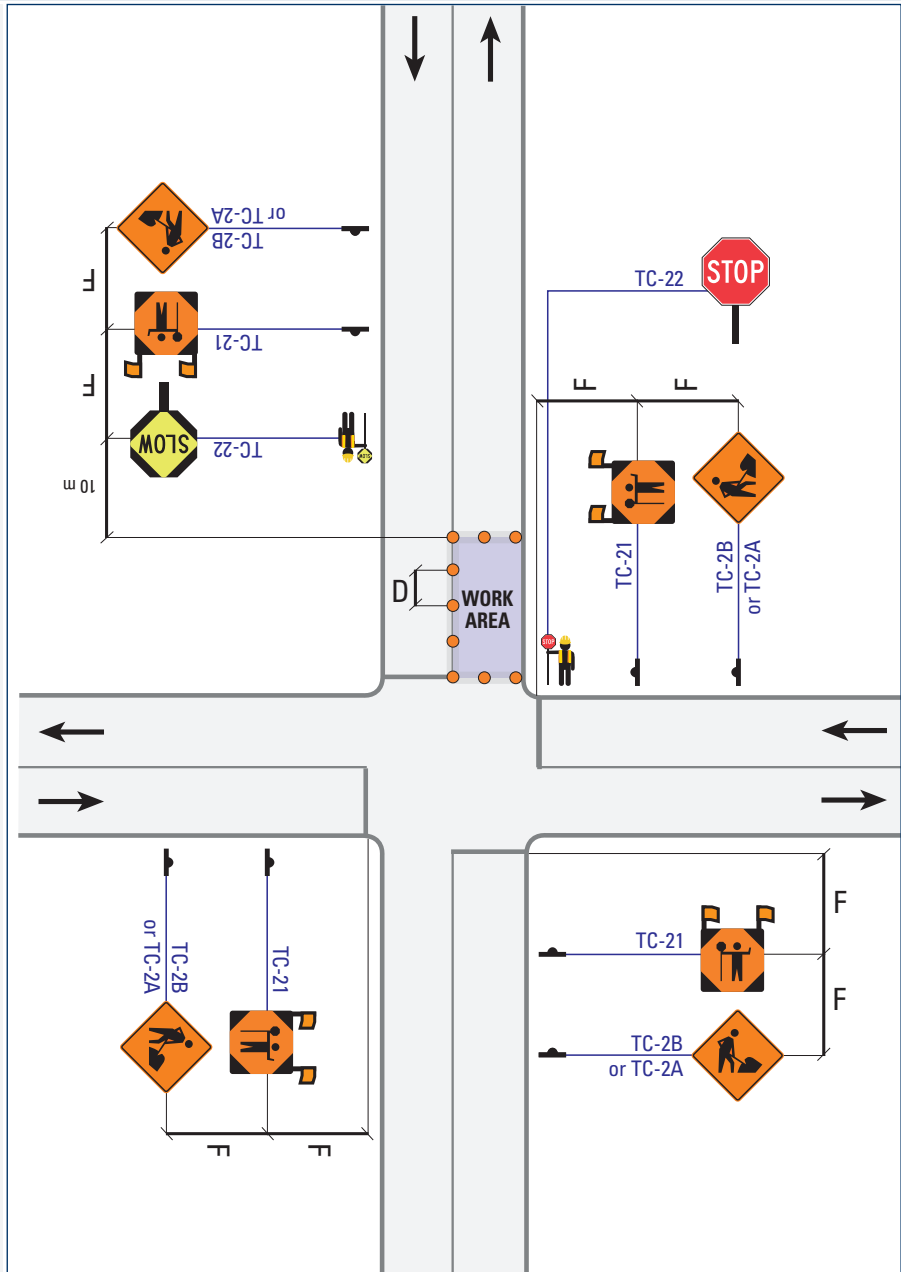

TWO-LANE TWO-WAY

Label	Description	Normal Posted Regulatory Speed (km/h)				
		50	60	70	80	90
<b>D</b>	Maximum Distance between Markers (m)	6	9	9	12	12
<b>F</b>	Distance between Construction Signs (m)	50	90	120	140	150



**TI-12 Work in Intersection: (TCP)**

**Two-Lane, Two-Way**

Mobile Operations

Intermittent

**Very Short Duration**

Short Duration

Long Duration

**NOTES**

i) When Traffic Volumes are High or when the intersection is signalized, consult the Road Authority to determine whether police assistance is required. Care should be taken by the TCP to coordinate with any intersection control such as traffic signals or STOP signs.

For further detail on Work Zone components see [Table A \(Mobile/ Intermittent/Very Short, pg. 240\)](#), and [TCP Table \(pg. 175\)](#).

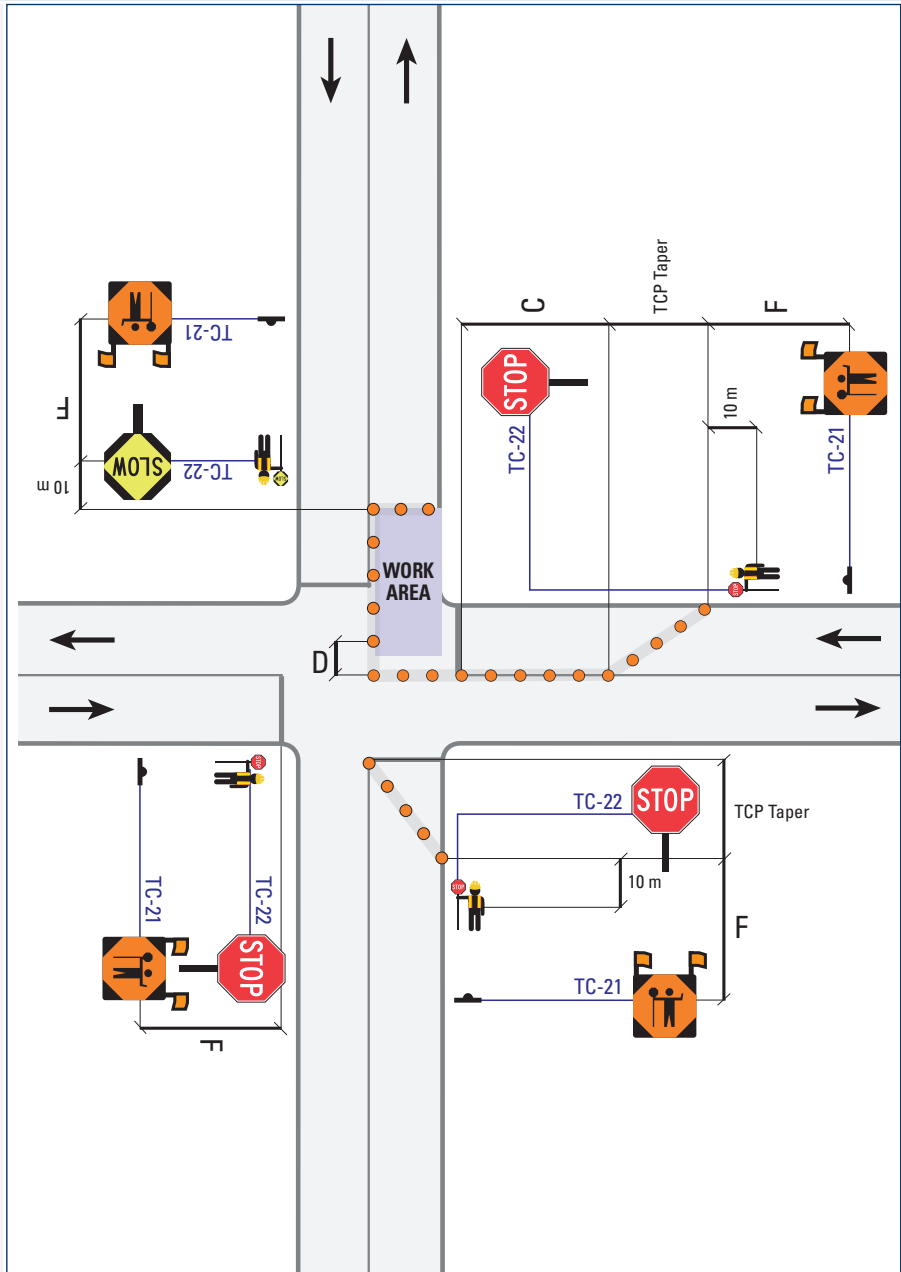

Label	Description	Normal Posted Regulatory Speed (km/h)				
		50	60	70	80	90
<b>TCP</b>	Taper Length for TCP Presence (m)	15	20	25	30	30
<b>C</b>	Longitudinal Buffer Area (LBA) (m)	(30)	(40)	50	60	75
<b>D</b>	Maximum Distance between Markers (m)	6	6	9	9	12
	Minimum Number of Markers for Taper	4	5	5	7	8
<b>F</b>	Distance between Construction Signs (m)	30	30	60	60	80

**TI-13**

**Work in Intersection: (TCP)**

**Two-Lane, Two-Way**

Mobile Operations

Intermittent

Very Short Duration

**Short Duration**

Long Duration

**NOTES**

i) When Traffic Volumes are High or when the intersection is signalized, consult the Road Authority to determine whether police assistance is required. Care should be taken by the TCP to coordinate with any intersection control such as traffic signals or STOP signs.

For further detail on Work Zone components see [Table B \(Short/Long, pg. 241\)](#), and [TCP Table \(pg. 175\)](#).

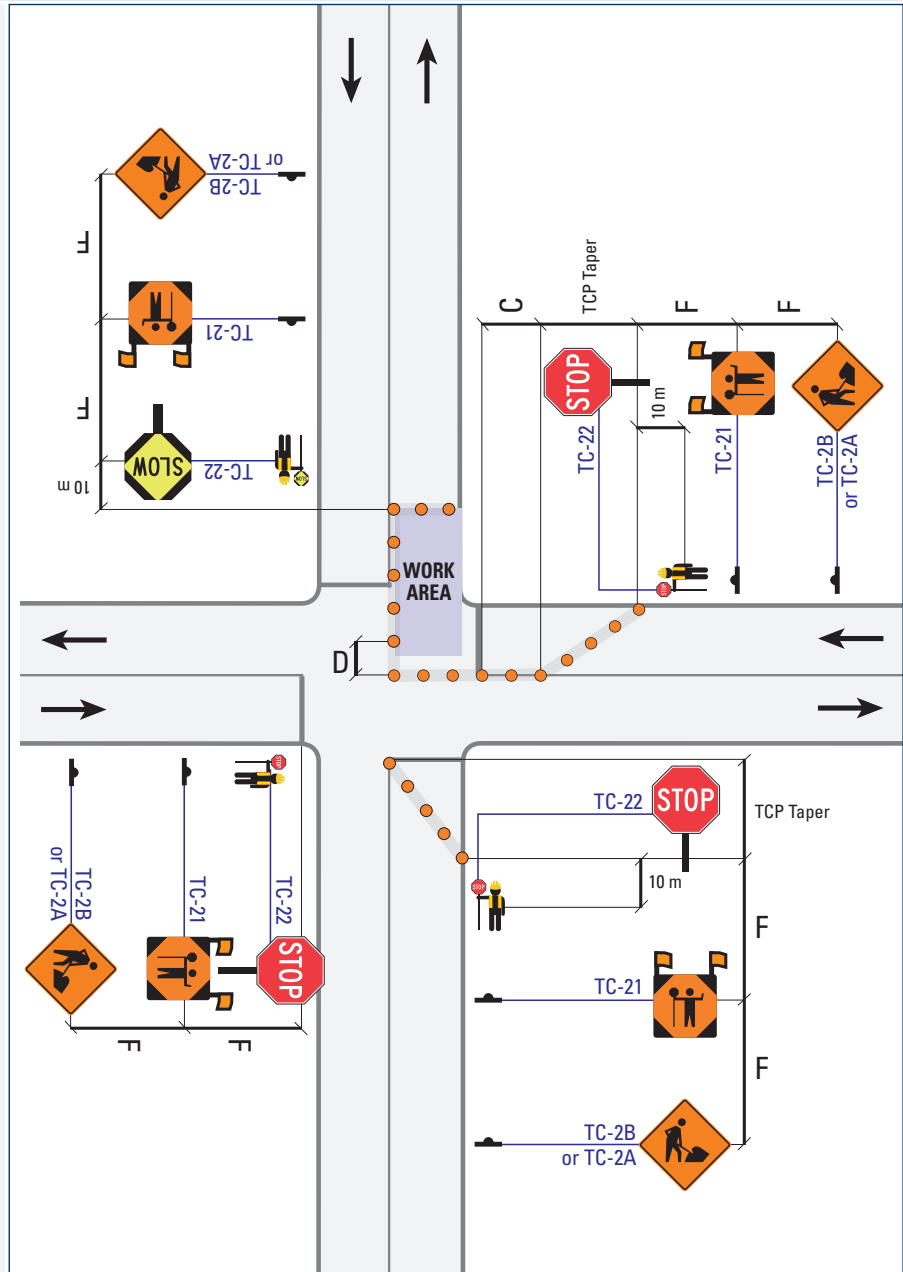

TWO-LANE  
TWO-WAY

Label	Description	Normal Posted Regulatory Speed (km/h)				
		50	60	70	80	90
<b>TCP</b>	Taper Length for TCP Presence (m)	15	20	25	30	30
<b>C</b>	Longitudinal Buffer Area (LBA) (m)	(30)	(40)	50	60	75
<b>D</b>	Maximum Distance between Markers (m)	6	9	9	12	12
	Minimum Number of Markers for Taper	5	7	9	11	13
<b>F</b>	Distance between Construction Signs (m)	50	90	120	140	150

**TI-14 Intersection: Far-Side Lane Closed (Detour)**

**Two-Lane, Two-Way**

Mobile Operations

Intermittent

Very Short Duration

Short Duration

Long Duration

**NOTES**

- i) If space permits, use TC-53A or TC-53B to surround the Work Area, otherwise reduce space between TC-54.
- ii) This layout is to be used if an alternate Route Detour is available; if not, TCP are required and the layout shown in TI-11 should be used.
- iii) See TS-21 and TS-22 for Detour signs and layout.
- iv) Flashing Amber Light above TC-7 must not be used at intersections with active signals.

For further detail on Work Zone components, see [Table B \(Short/Long, pg. 241\)](#).

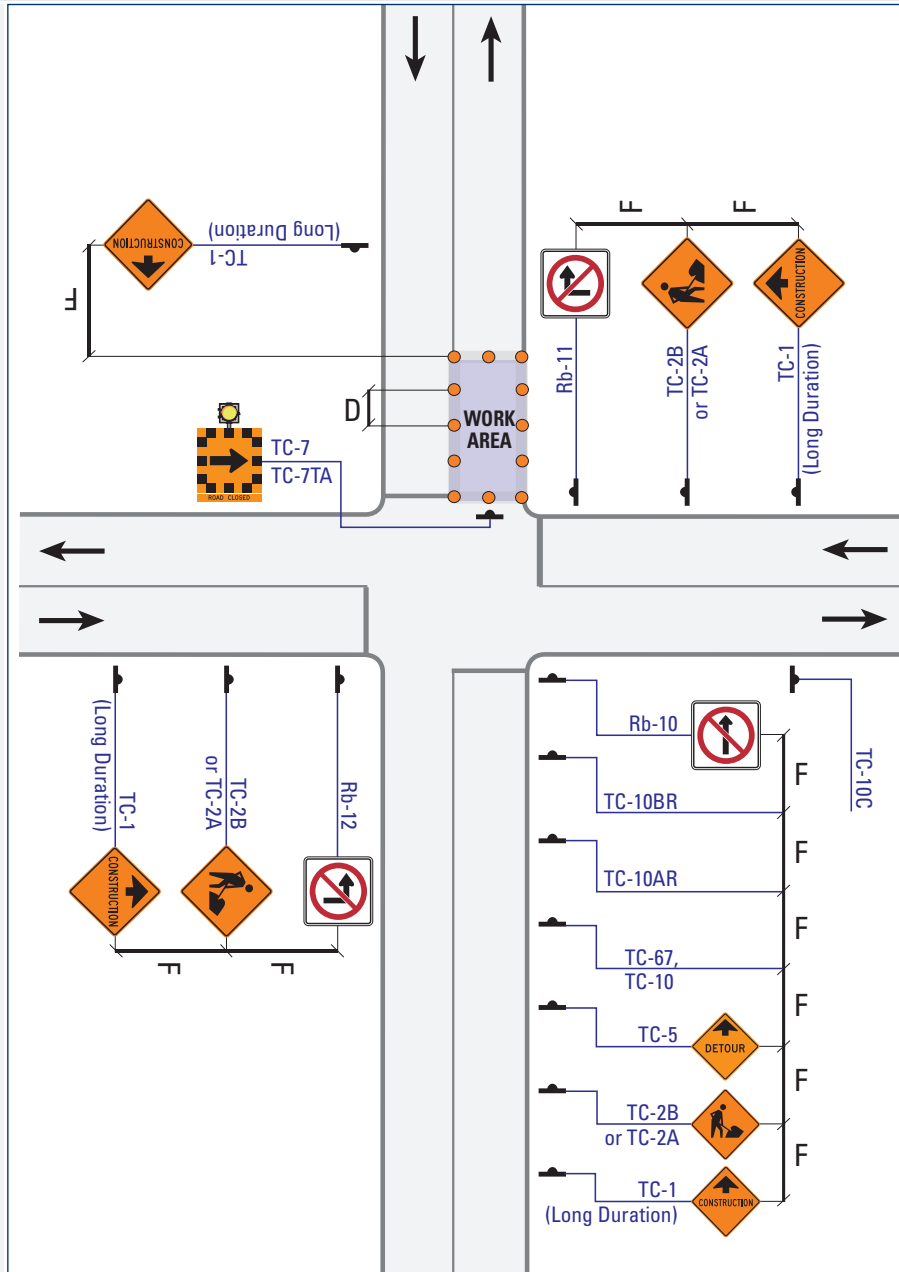

**Normal Posted Regulatory Speed (km/h)**

Label	Description	50	60	70	80	90
<b>D</b>	Maximum Distance between Markers (m)	6	9	9	12	12
<b>F</b>	Distance between Construction Signs (m)	50	90	120	140	150



**TI-15**

**Work in Intersection: Near-Side Lane Closed (Detour)**

**Two-Lane, Two-Way**

Mobile Operations

Intermittent

Very Short Duration

Short Duration

Long Duration

**NOTES**

- i) If space permits, use TC-53A or TC-53B to surround the Work Area, otherwise reduce space between TC-54.
- ii) This layout is to be used if an alternate Route Detour is available; if not, TCP are required and the layout shown in TI-11 should be used.
- iii) See TS-21 and TS-22 for Detour signs and layout.
- iv) Flashing Amber Light above TC-7 must not be used at intersections with active signals.

For further detail on Work Zone components, see [Table B \(Short/Long, pg. 241\)](#).

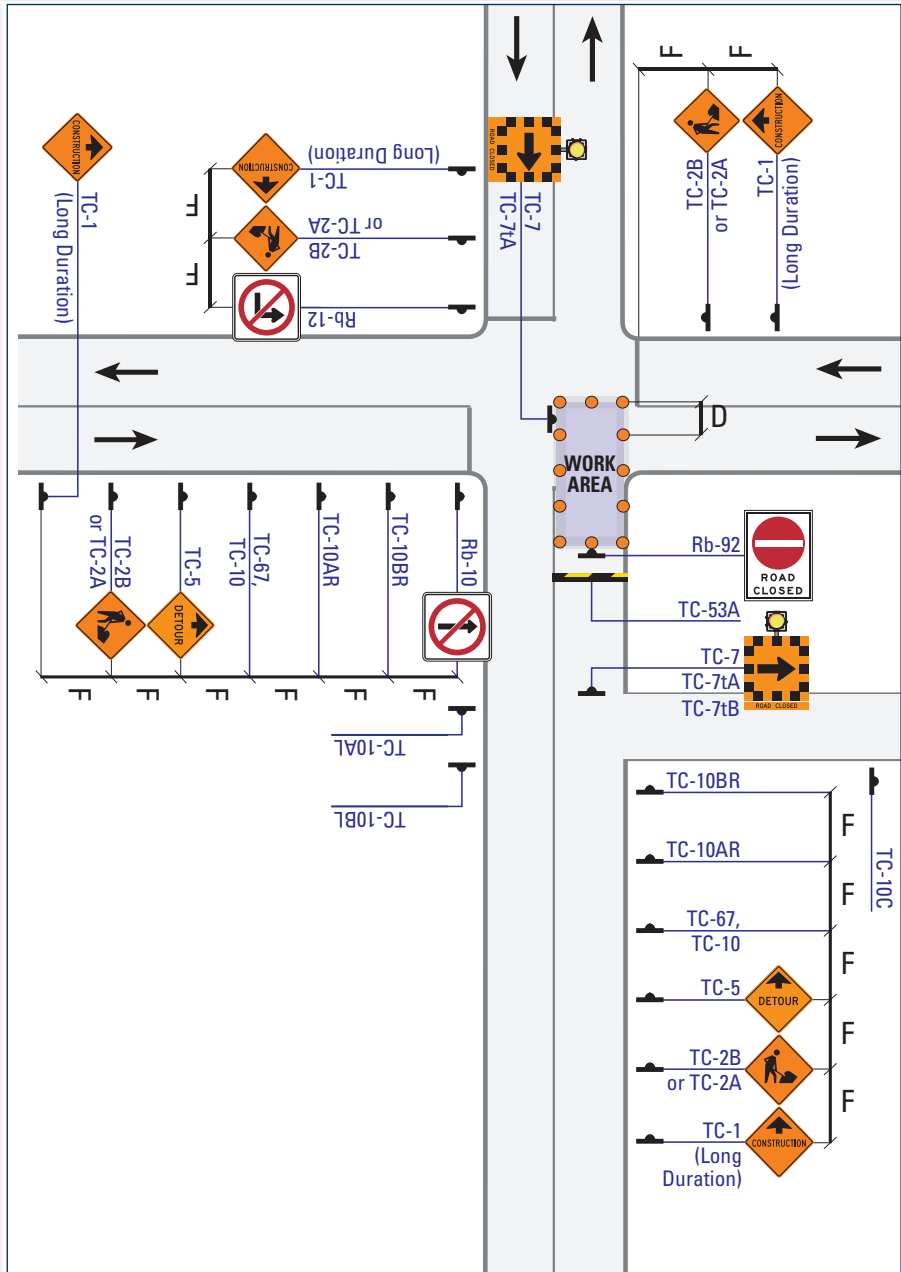

Normal Posted Regulatory Speed (km/h)

Label	Description	50	60	70	80	90
<b>D</b>	Maximum Distance between Markers (m)	6	9	9	12	12
	Minimum Number of Markers for Taper	5	7	9	11	13
<b>F</b>	Distance between Construction Signs (m)	50	90	120	140	150

**TI-16 Pedestrian Detour: Crosswalk Closure**

**Two-Lane, Two-Way**

Mobile Operations

Intermittent

Very Short Duration

**Short Duration**

Long Duration

**NOTES**

i) Supplementary layout. This layout shows pedestrian signage only and shall be used in conjunction with other appropriate layouts.

ii) See TS-21, TS-22, and TI-9 for required signage for vehicle Detour.

For further detail on Work Zone components, see [Table B \(Short/Long, pg. 241\)](#).

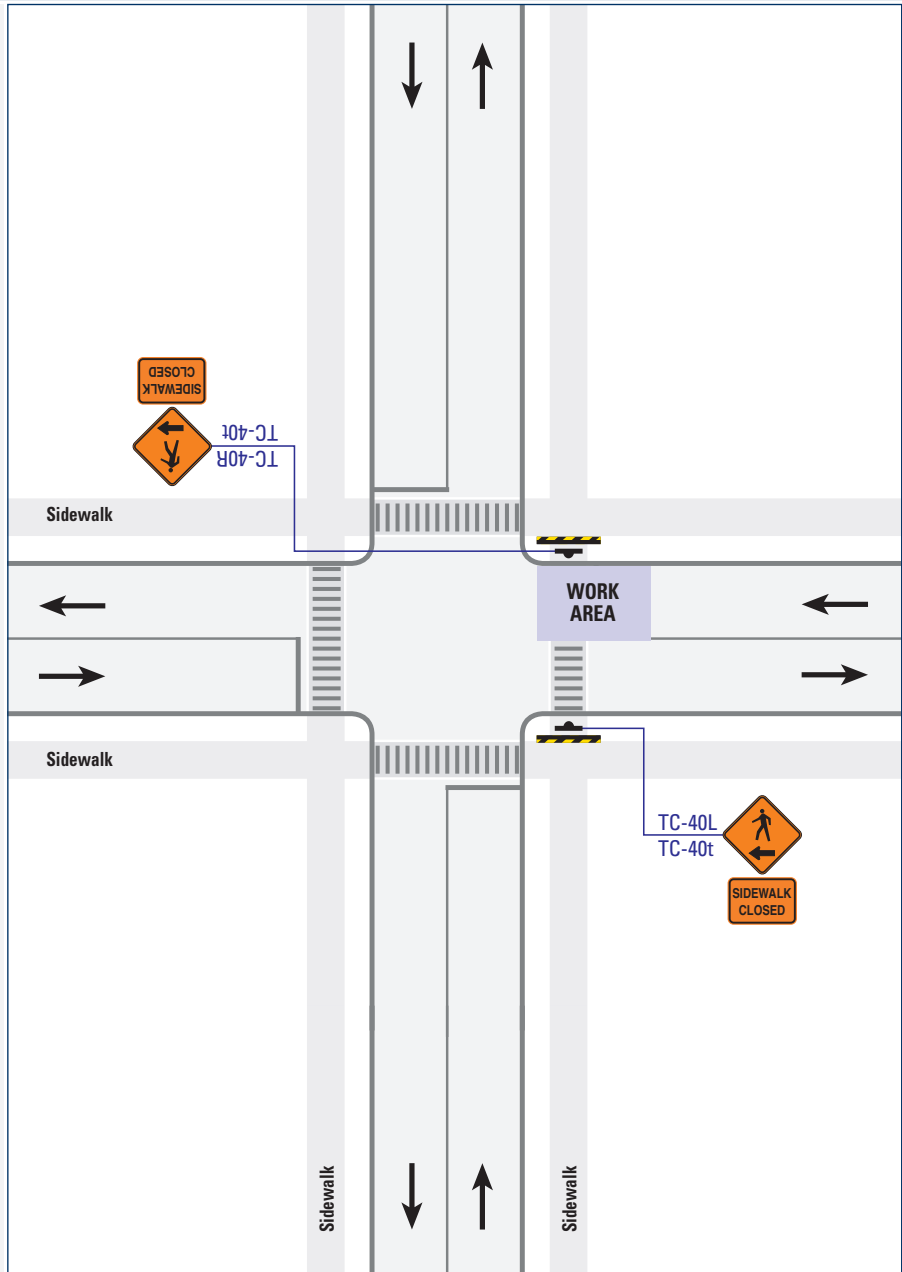

TWO-LANE  
TWO-WAY

TI-17

Pedestrian Detour: Crosswalk and Sidewalk Closure

Two-Lane, Two-Way

Mobile Operations

Intermittent

Very Short Duration

Short Duration

Long Duration

NOTES

i) TC-40L/R Pedestrian Direction sign must be placed at the nearest upstream controlled pedestrian crossing (traffic signal or Pedestrian Crossover) in each direction.

For further detail on Work Zone components, see [Table B \(Short/Long, pg. 241\)](#).

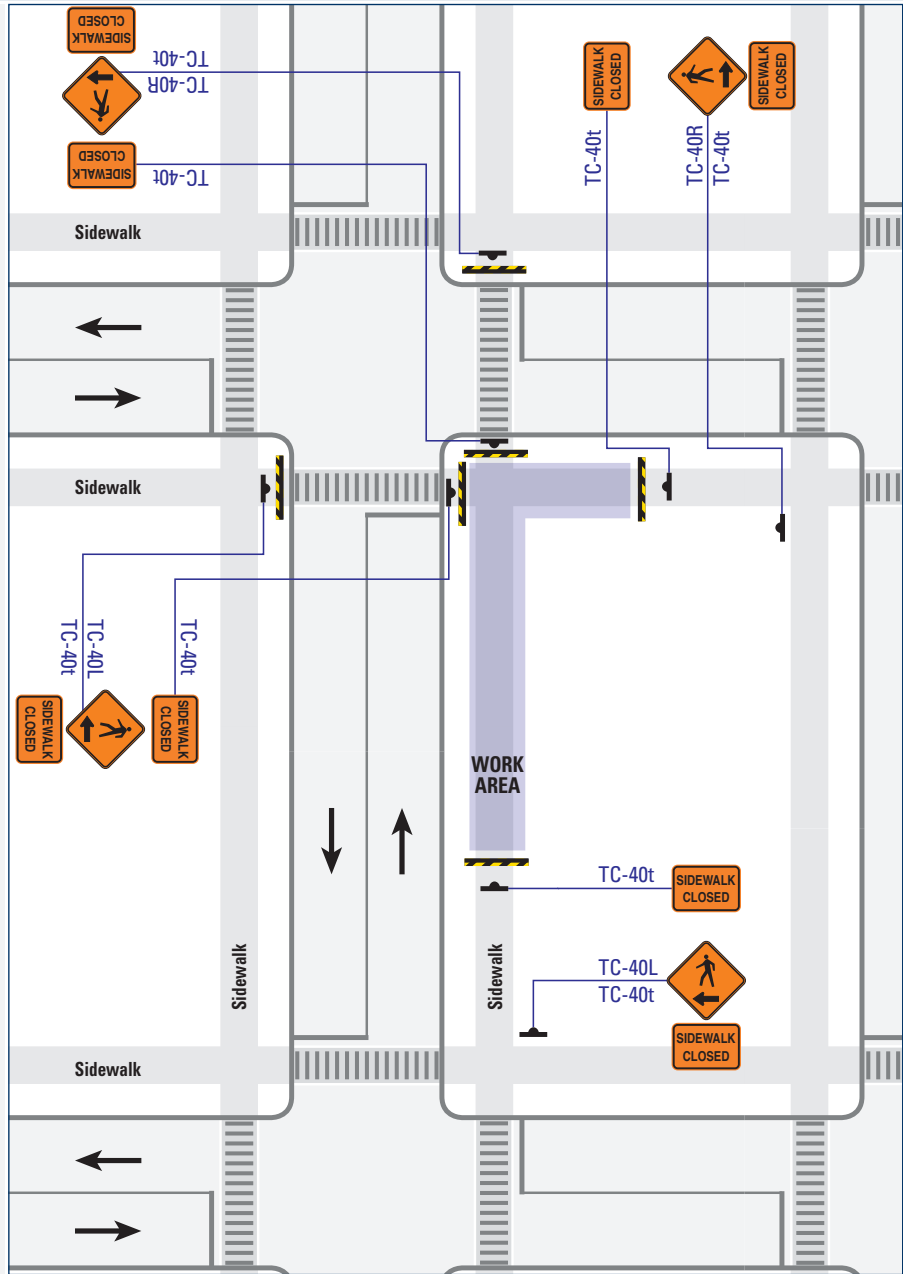

**TI-18 Cyclist: Detour**

Two-Lane, Two-Way Mobile Operations Intermittent Very Short Duration Short Duration Long Duration

**NOTES**

Shared lane only to be used if considered by OTM Book 18 or MTO Bikeways Design Manual, Desirable Cycling Facility Nomograph. Otherwise, cycling Detour should be provided.

For further detail on Work Zone components, see Table B (Short/Long, pg. 241).

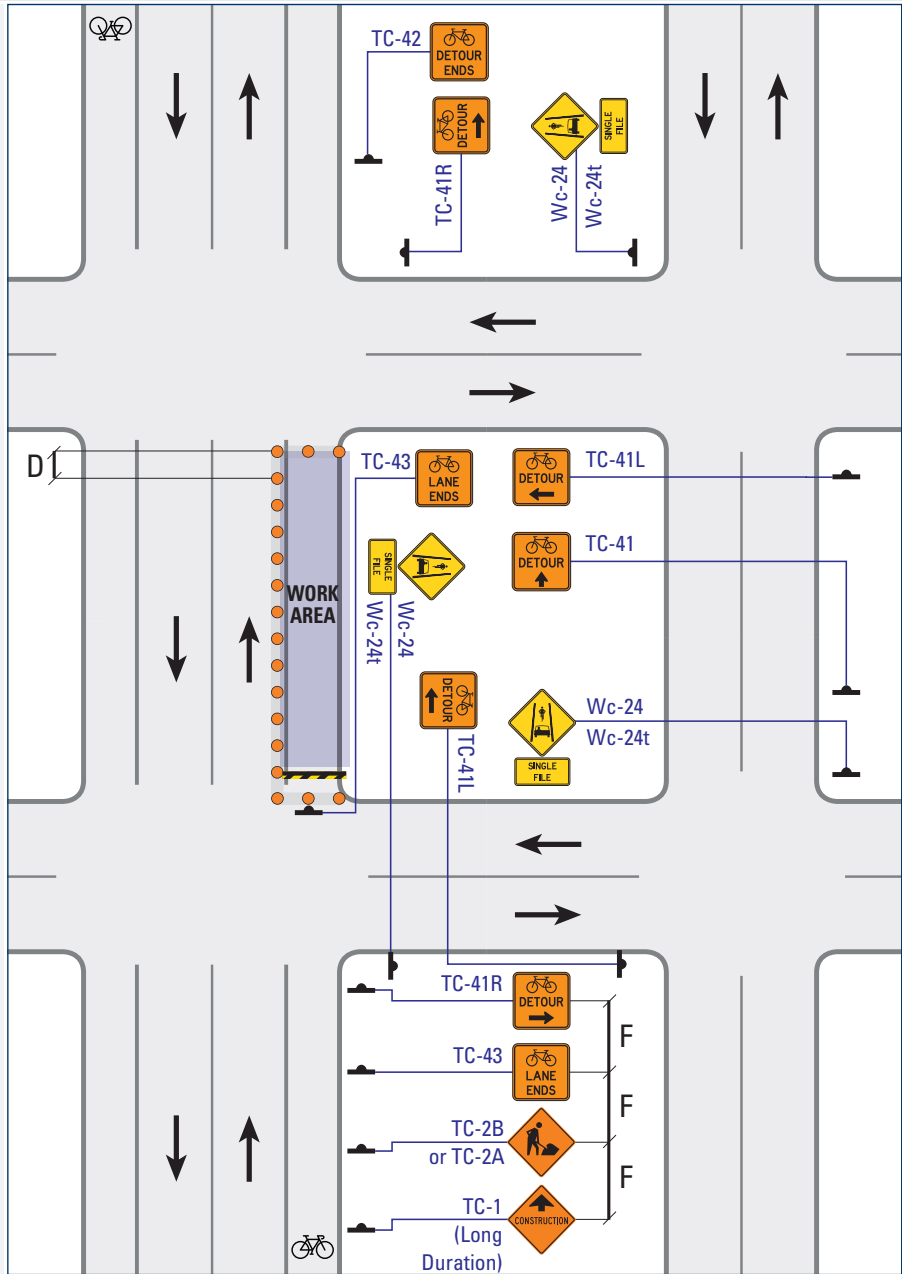

TWO-LANE  
TWO-WAY

Label	Description	Normal Posted Regulatory Speed (km/h)				
		50	60	70	80	90
<b>D</b>	Maximum Distance between Markers (m)	6	9	9	12	12
<b>F</b>	Distance between Construction Signs (m)	50	90	120	140	150

**TI-19 Bicycle Lane Closed: Dismount and Walk**

**Two-Lane, Two-Way**

Mobile Operations

Intermittent

Very Short Duration

Short Duration

Long Duration

**NOTES**

i) Supplementary layout. This layout shows cyclist signage only and shall be used in conjunction with other appropriate layouts.

ii) See TS-21 & TS-22 for required signage for vehicle Detour.

iii) Ramps must be AODA-compliant.

For further detail on Work Zone components, see [Table B \(Short/Long, pg. 241\)](#).

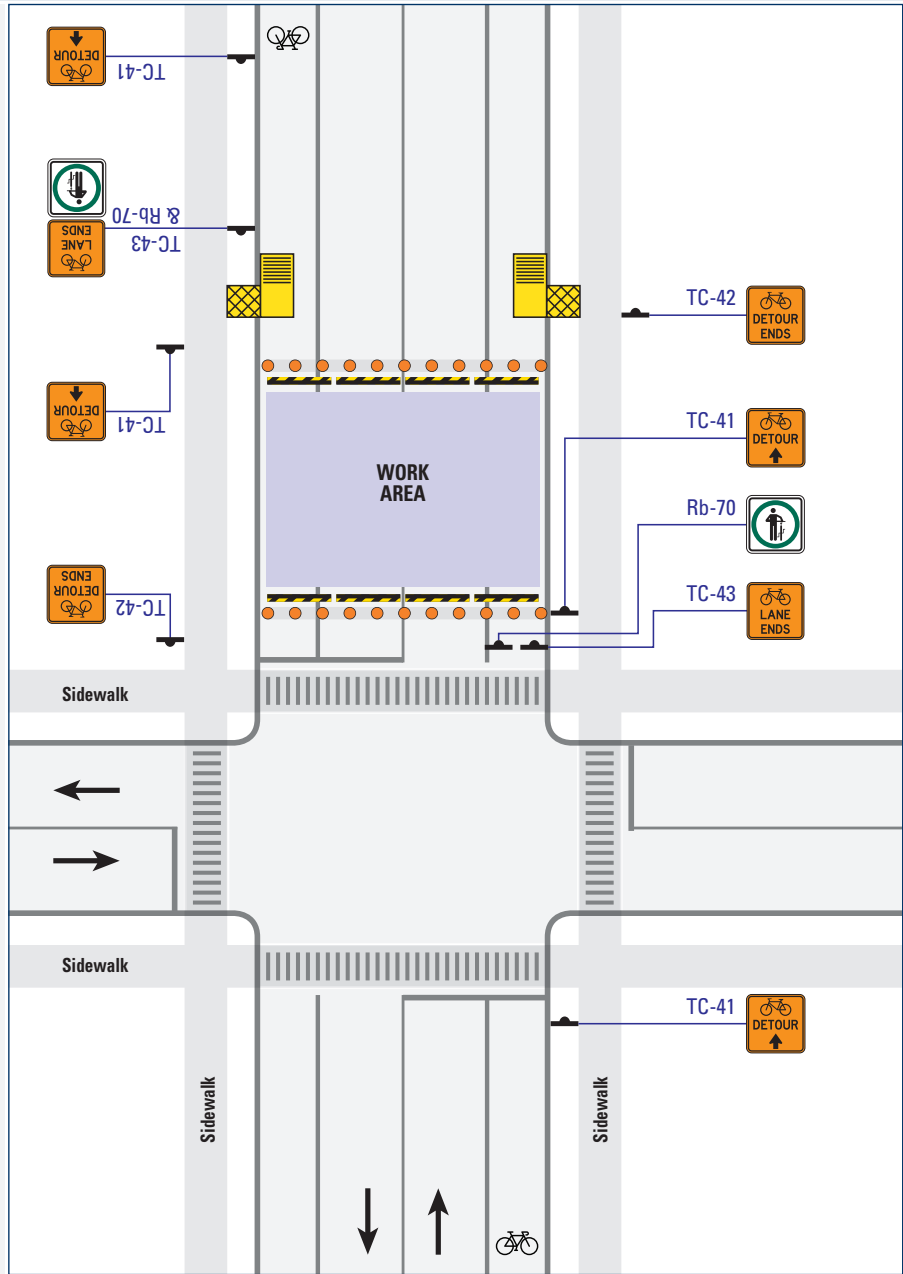



**TO-1 Roundabout: Encroachment**

**Two-Lane, Two-Way**

Mobile Operations

Intermittent

**Very Short Duration**

Short Duration

Long Duration

**NOTES**

- i) It may be necessary to leave a wider lane width if there is a high truck percentage.
- ii) Total width of 6 m must be maintained. If minimum lane widths cannot be maintained then see Lane Closure layouts.
- iii) Markers are not required if a Work Vehicle with Beacon + 4WF or TC-12 is present.

For further detail on Work Zone components, see [Table A \(Mobile/Intermittent/Very Short, pg. 240\)](#).

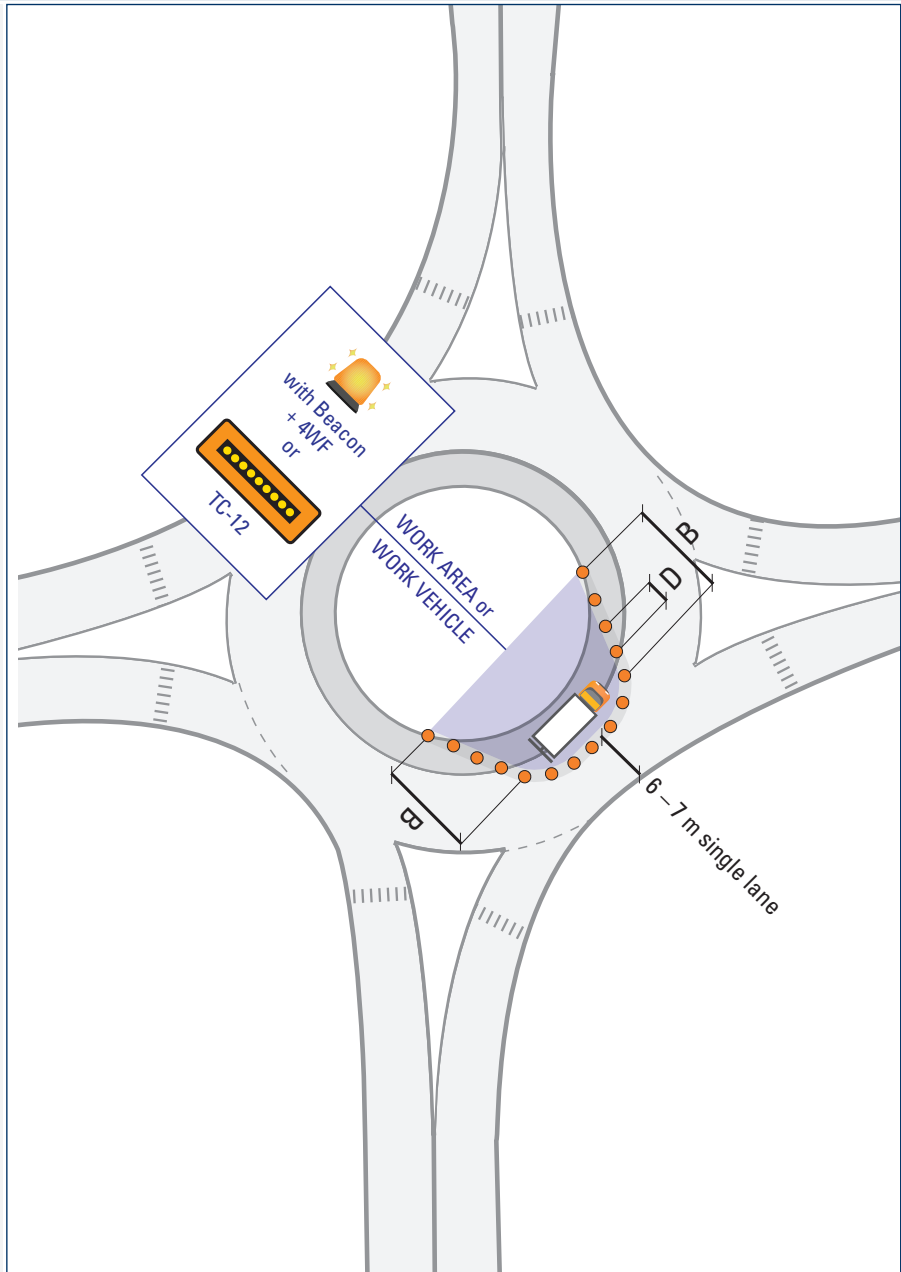

Label	Description	Normal Posted Regulatory Speed (km/h)				
		50	60	70	80	90
<b>B</b>	Shoulder Taper (m)	20	30	35	35	40
<b>D</b>	Maximum Distance between Markers (m)	6	6	9	9	12
	Minimum Number of Markers for Taper	4	5	5	7	8
<b>F</b>	Distance between Construction Signs (m)	30	30	60	60	80

**TO-2 Roundabout: Encroachment**

Two-Lane, Two-Way    Mobile Operations    Intermittent    Very Short Duration    **Short Duration**    Long Duration

**NOTES**

- i) It may be necessary to leave a wider lane width if there is a high truck percentage.
- ii) Total width of 6 m must be maintained. If minimum lane widths cannot be maintained then see Lane Closure layouts.

For further detail on Work Zone components, see [Table B \(Short/Long, pg. 241\)](#).

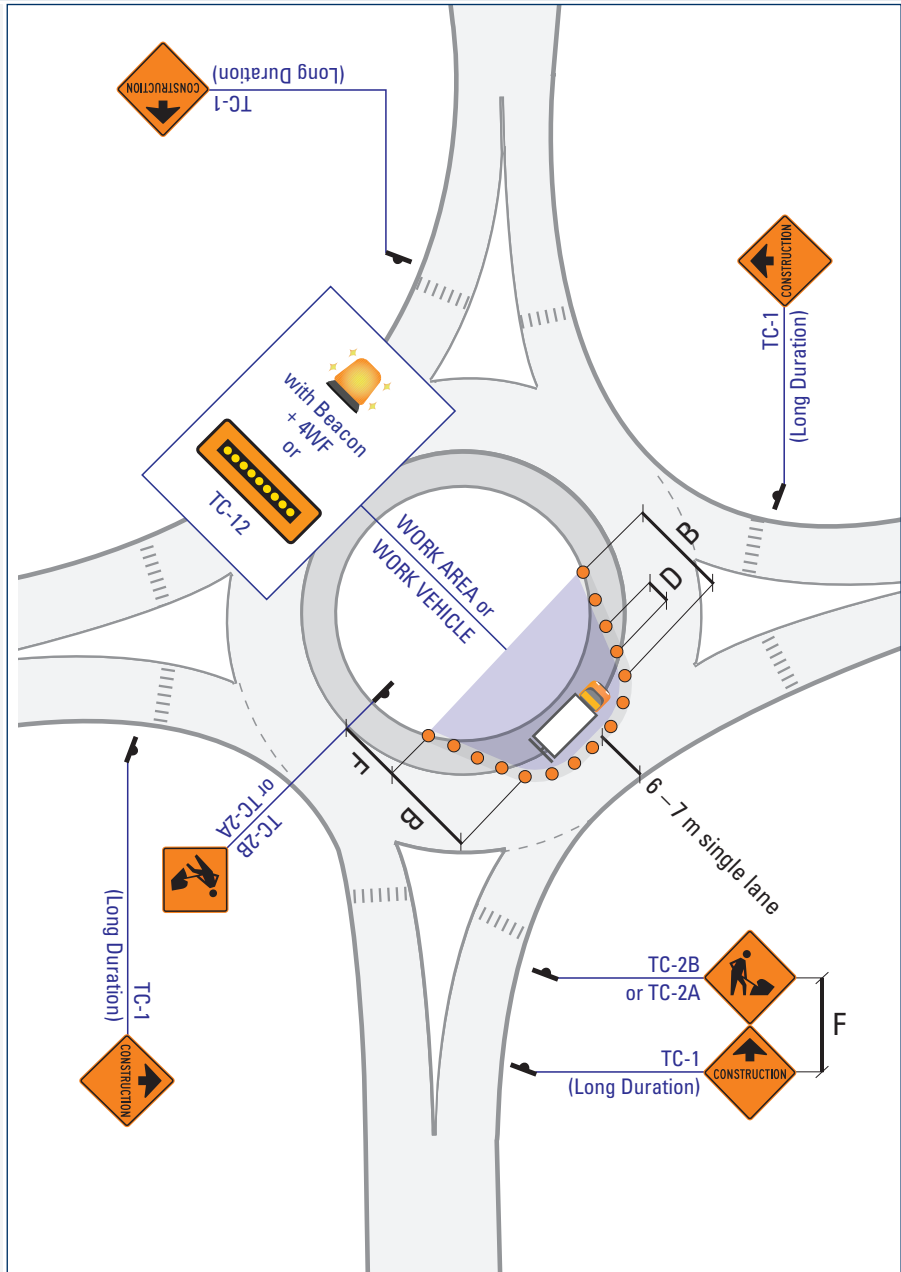

TWO-LANE TWO-WAY

Label	Description	Normal Posted Regulatory Speed (km/h)				
		50	60	70	80	90
<b>B</b>	Shoulder Taper (m)	20	30	55	60	70
<b>D</b>	Maximum Distance between Markers (m)	6	9	9	12	12
	Minimum Number of Markers for Taper	5	7	9	11	13
<b>F</b>	Distance between Construction Signs (m)	50	90	120	140	150

**TO-3 Roundabout: Quadrant Closed (Traffic Control Persons)**

**Two-Lane, Two-Way** Mobile Operations Intermittent Very Short Duration Short Duration Long Duration

**NOTES**

- i) TCP must be in communication with each other to ensure only one entrance has a TC-22 showing SLOW at any time. TCP must be present at all times.
- ii) Roundabout must be cleared before next entrance has SLOW indication.
- iii) For Long Duration, TC-1 is required distance F in advance of the TC-2A or TC-2B on each approach. For Long Duration, TC-1A is also required on Rural Highways and/or if the NPRS is 70 km/h or higher.
- iv) Use of AFAD or PLCS is NOT permitted.
- v) Permanent signs (such as Rb-21, Rb-19, Rb-20, Rb-25, and overhead guide signs) that may conflict with the direction of travel the motorist is being directed must be covered. Permanent signing must be restored once contractor leaves site.
- vi) Any existing signs that contradict or that are duplicated should be covered.

For further detail on Work Zone components see [Table B \(Short/Long, pg. 241\)](#), and [TCP Table \(pg. 175\)](#).

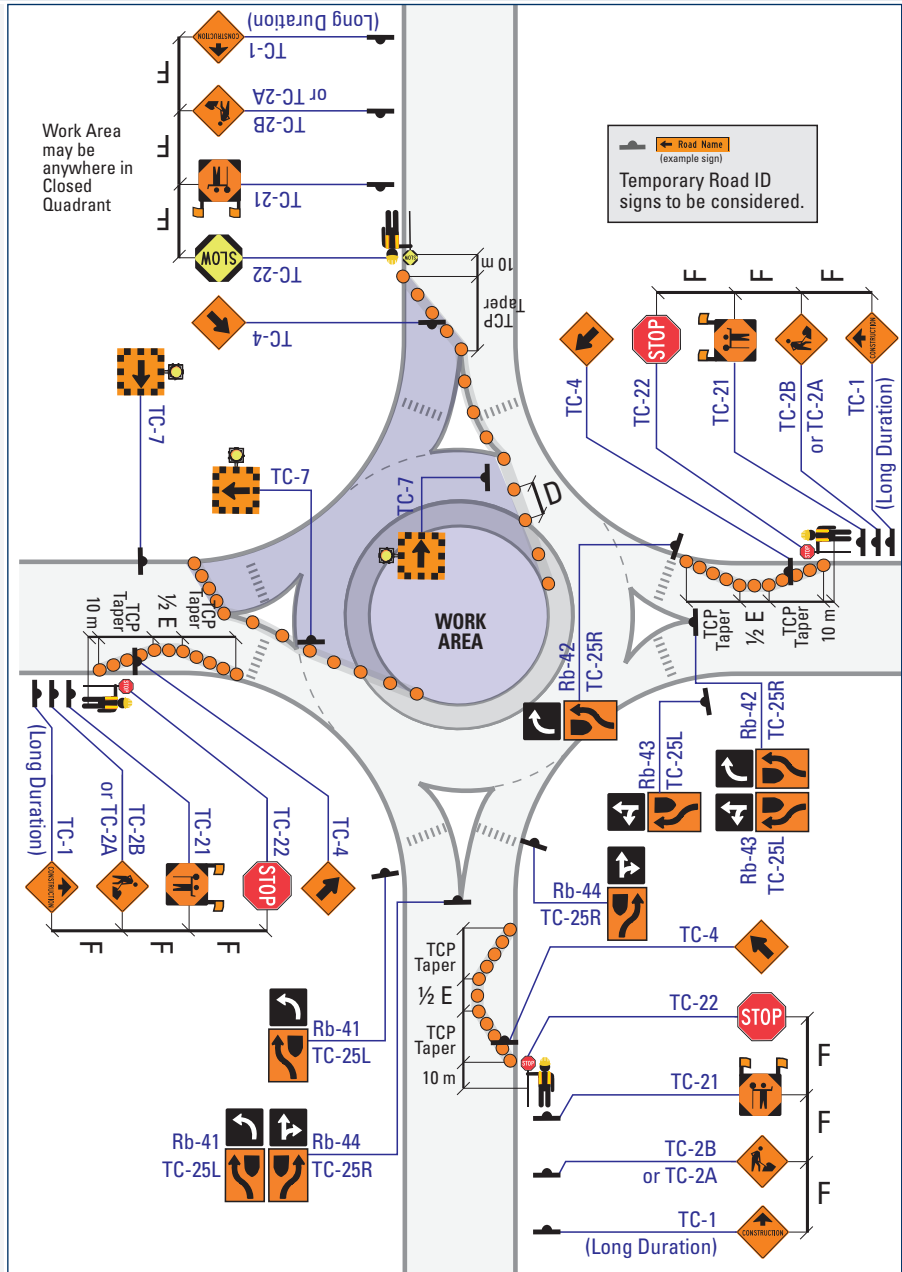

**Normal Posted Regulatory Speed (km/h)**

Label	Description	50	60	70	80	90
<b>TCP</b>	Taper Length for TCP Presence (m)	15	20	25	30	30
<b>D</b>	Maximum Distance between Markers (m)	6	9	9	12	12
	Minimum Number of Markers for Taper	5	7	9	11	13
<b>E</b>	Minimum Tangent between Tapers (m)	60	85	155	180	200
<b>F</b>	Distance between Construction Signs (m)	50	90	120	140	150

TWO-LANE  
TWO-WAY

**TO-4 Roundabout: One Exit Closed (Detour)**

Two-Lane, Two-Way    Mobile Operations    Intermittent    Very Short Duration    Short Duration    Long Duration

**NOTES**

i) See TS-21 and TS-22 for Detour signing in advance and beyond the Roundabout.

ii) Any existing signs that contradict or that are duplicated should be covered.

For further detail on Work Zone components, see Table B (Short/Long, pg. 241).

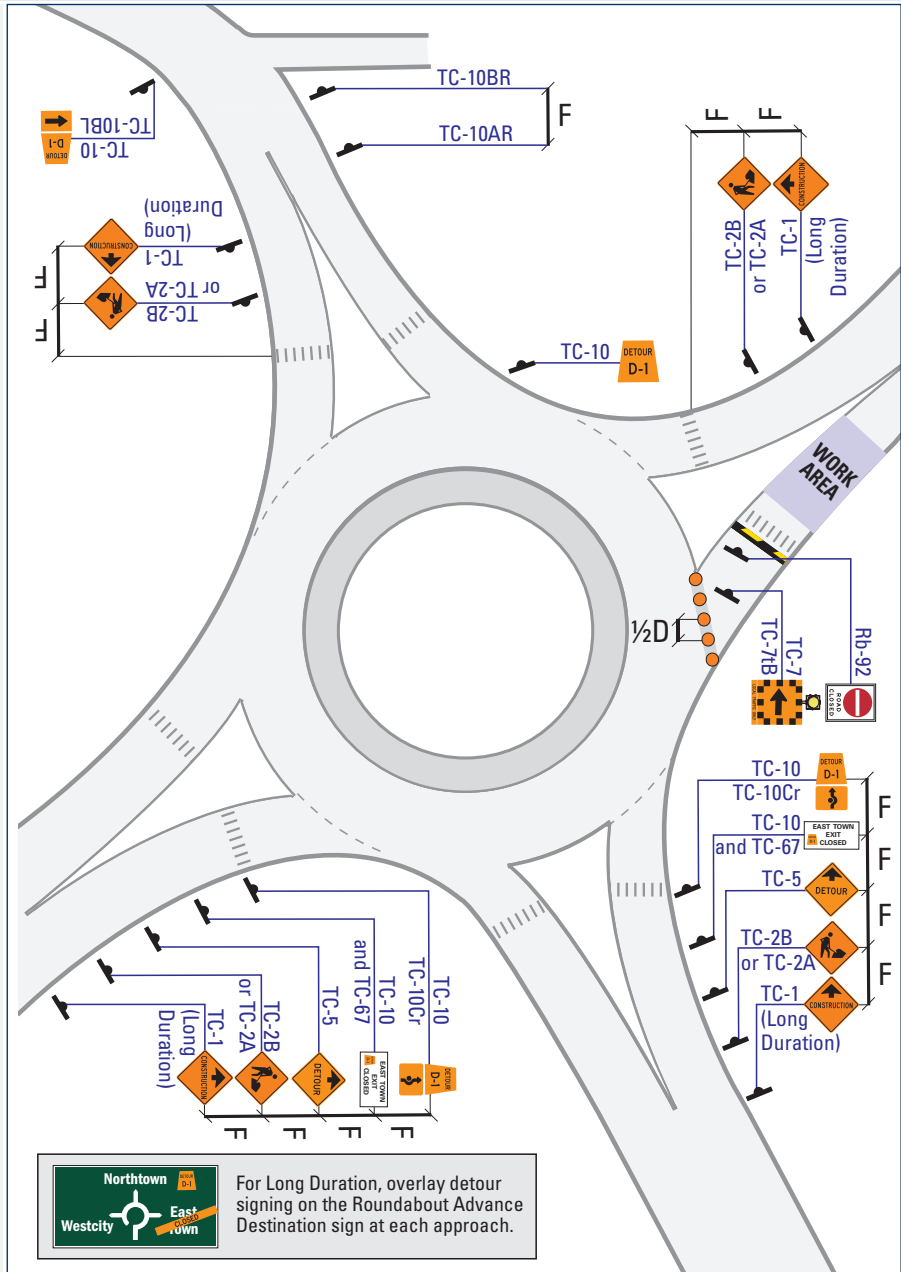

TWO-LANE  
TWO-WAY

Label	Description	Normal Posted Regulatory Speed (km/h)				
		50	60	70	80	90
<b>D</b>	Maximum Distance between Markers (m)	6	9	9	12	12
	Minimum Number of Markers for Taper	5	7	9	11	13
<b>F</b>	Distance between Construction Signs (m)	50	90	120	140	150

**UG-1 Designated Construction Zone Signing**

**Multi-Lane Undivided** Mobile Operations Intermittent Very Short Duration Short Duration **Long Duration**

**NOTES**

- i) The same signing is required in the opposite direction.
- ii) Recommended, but not required.
- iii) Where required by contract.
- iv) Supplementary layout. This layout shall be used in conjunction with other appropriate layouts. Locations of TC-1, TC-1A, TC-1B shown in UG-1 overrides the locations shown in other layouts when used in conjunction with UG-1.

For further detail on Work Zone components, see [Table B \(Short/Long, pg. 241\)](#).

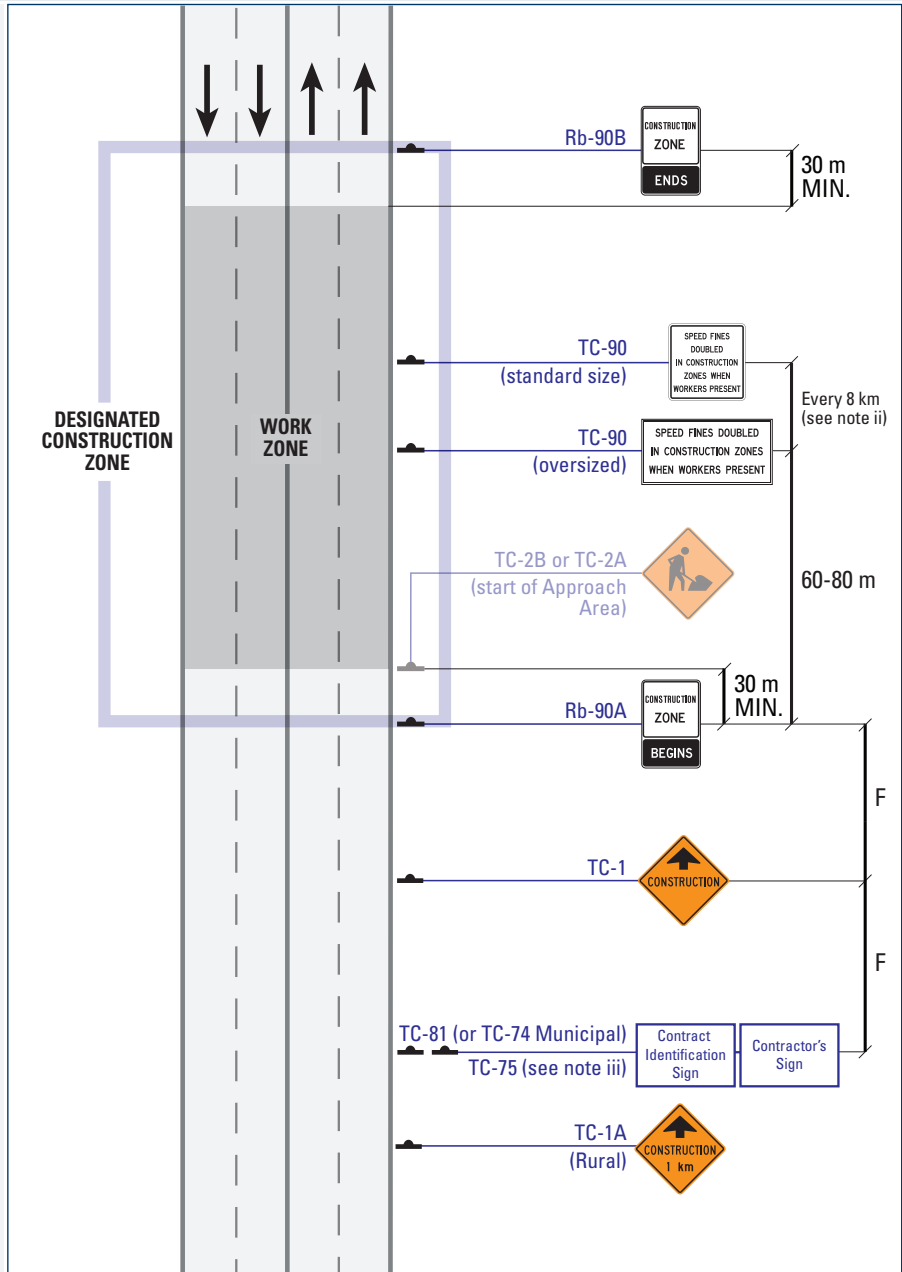

Label	Description	Normal Posted Regulatory Speed (km/h)				
		50	60	70	80	90
<b>F</b>	Distance between Construction Signs (m)	50	90	120	140	150

**UG-2 Reduced Speed Zone Signing**

**Multi-Lane Undivided** Mobile Operations Intermittent Very Short Duration **Short Duration** Long Duration

**NOTES**

- i) Refer to Regulation 615 of the Highway Traffic Act and OTM Book 5 for distance between regulatory speed limit signs.
- ii) For Regulatory Speed Reduction, a Designated Construction Zone must be established and signed as per UG-1.
- iii) Reduced Speed Zone may include all of or only part(s) of the Designated Construction Zone.
- iv) Additional signs may be required based on the length of zone.
- v) Supplementary layout. This layout shall be used in conjunction with other appropriate layouts.

For further detail on Work Zone components, see [Table B \(Short/Long, pg. 241\)](#).

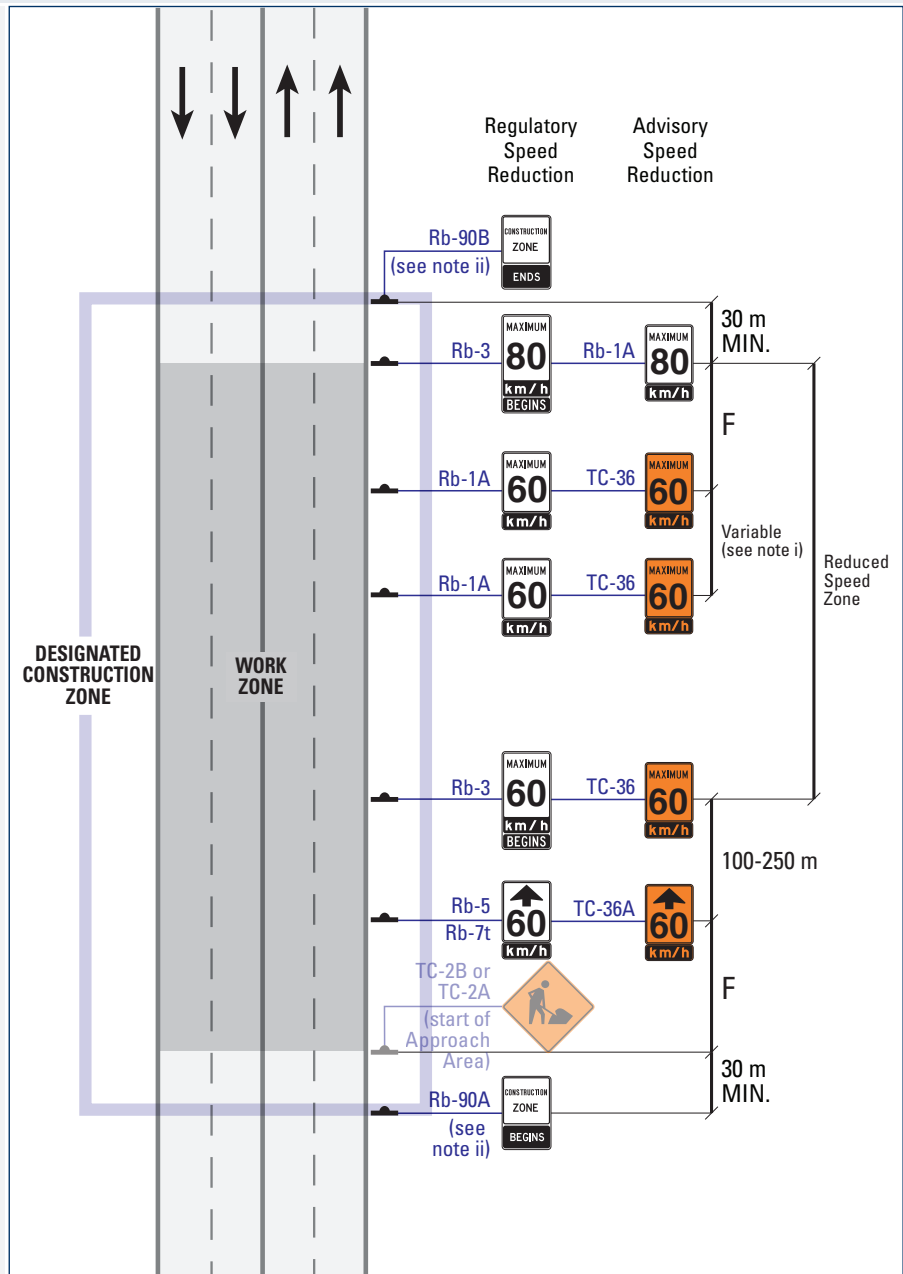

**Normal Posted Regulatory Speed (km/h)**

Label	Description	50	60	70	80	90
<b>F</b>	Distance between Construction Signs (m)	50	90	120	140	150

**US-1 Intermittent Work**

**Multi-Lane Undivided** Mobile Operations **Intermittent** Very Short Duration Short Duration Long Duration

**NOTES**

Where a worker is moving within the Intermittent Work Area with only brief stationary moments, for example, pothole patching:

- Worker requires sight distance (refer to H in Table).
- Spotter(s) required when sight distance is not available.
- Where clear and constant verbal communication is not possible (i.e., distance, noise), spotter(s) and worker must use two-way communication devices.
- Where required sight distances (refer to H in Table) are present and the worker/technician's activities permit a continuous consciousness of approaching traffic, a spotter may not be required.
- Worker must not interfere with traffic.

Note: this would allow for a single worker operation (i.e., surveyor or possibly one-person pothole repair).

For further detail on Work Zone components, see [Table A \(Mobile/Intermittent/Very Short, pg. 240\)](#).

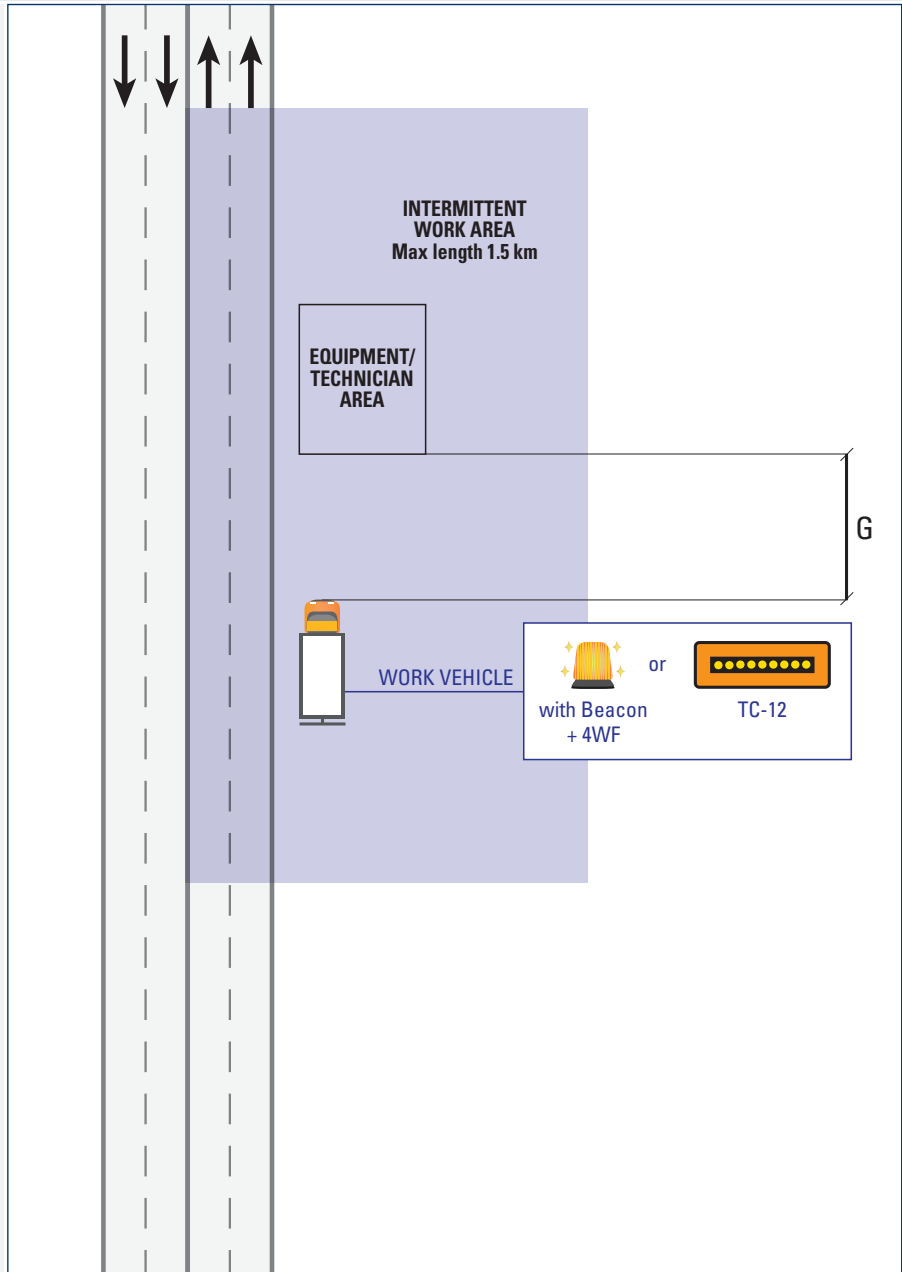

Label	Description	Normal Posted Regulatory Speed (km/h)				
		50	60	70	80	90
<b>G</b>	Stationary Work (Lateral Intrusion Deterrence Gap (LIDG) (m)	(35)	(40)	50	60	65
<b>H</b>	Sight Distance (m)	150	150	200	250	250

**US-2 Intermittent Work**

**Multi-Lane Undivided** Mobile Operations Intermittent **Very Short Duration** Short Duration Long Duration

**NOTES**

i) A Work Vehicle with a TC-12 may replace Markers.

**Where a worker is moving within the Intermittent Work Area with only brief stationary moments, for example, debris cleanup:**

- Worker requires sight distance (refer to H in Table).
- Spotter(s) required when sight distance is not available.
- Where clear and constant verbal communication is not possible (i.e., distance, noise), spotter(s) and worker must use two-way communication devices.
- Where required sight distances (refer to H in Table) are present and the worker/technician's activities permit a continuous consciousness of approaching traffic, a spotter may not be required.
- Worker must not interfere with traffic.

**Note:** this would allow for a single worker operation (i.e., surveyor or possibly one-person pothole repair).

For further detail on Work Zone components, see [Table A \(Mobile/Intermittent/Very Short, pg. 240\)](#).

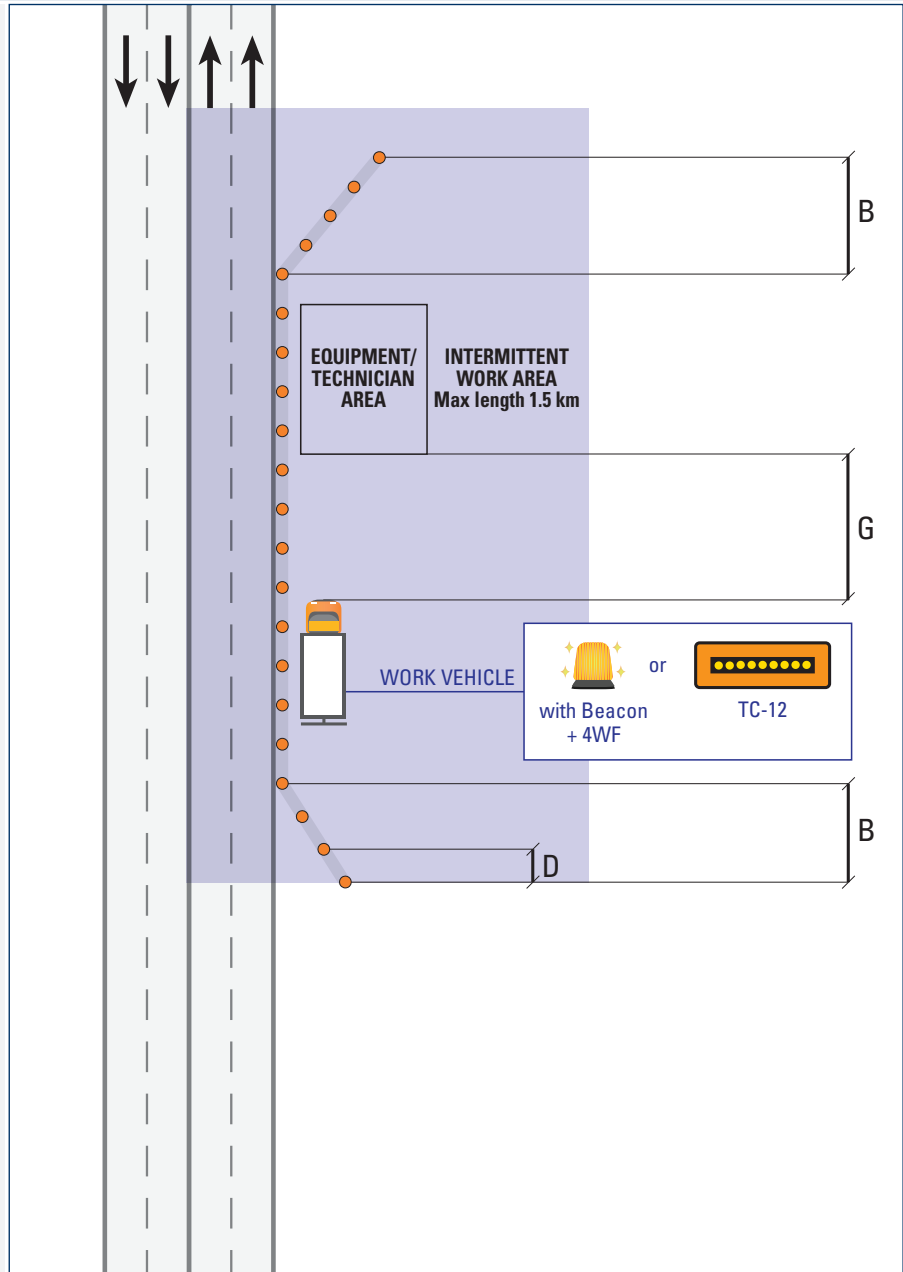

Normal Posted Regulatory Speed (km/h)

Label	Description	50	60	70	80	90
<b>B</b>	Shoulder Taper (m)	20	30	35	35	40
<b>D</b>	Maximum Distance between Markers (m)	6	6	9	9	12
	Minimum Number of Markers for Taper	4	5	5	7	8
<b>G</b>	Stationary Work (Lateral Intrusion Deterrence Gap (LIDG) (m)	(35)	(40)	50	60	65
<b>H</b>	Sight Distance (m)	150	150	200	250	250



**US-3 Intermittent Work**

**Multi-Lane Undivided** Mobile Operations Intermittent Very Short Duration **Short Duration** Long Duration

**NOTES**

i) A Work Vehicle with a TC-12 may replace Markers.

Where a worker is moving within the Intermittent Work Area with only brief stationary moments, for example, surveying:

- Worker requires sight distance (refer to H in Table).
- Spotter(s) required when sight distance is not available.
- Where clear and constant verbal communication is not possible (i.e., distance, noise), spotter(s) and worker must use two-way communication devices.
- Where required sight distances (refer to H in Table) are present and the worker/technician's activities permit a continuous consciousness of approaching traffic, a spotter may not be required.
- Worker must not interfere with traffic.

Note: this would allow for a single worker operation (i.e., surveyor or possibly one-person pothole repair).

For further detail on Work Zone components, see Table B (Short/Long, pg. 241).

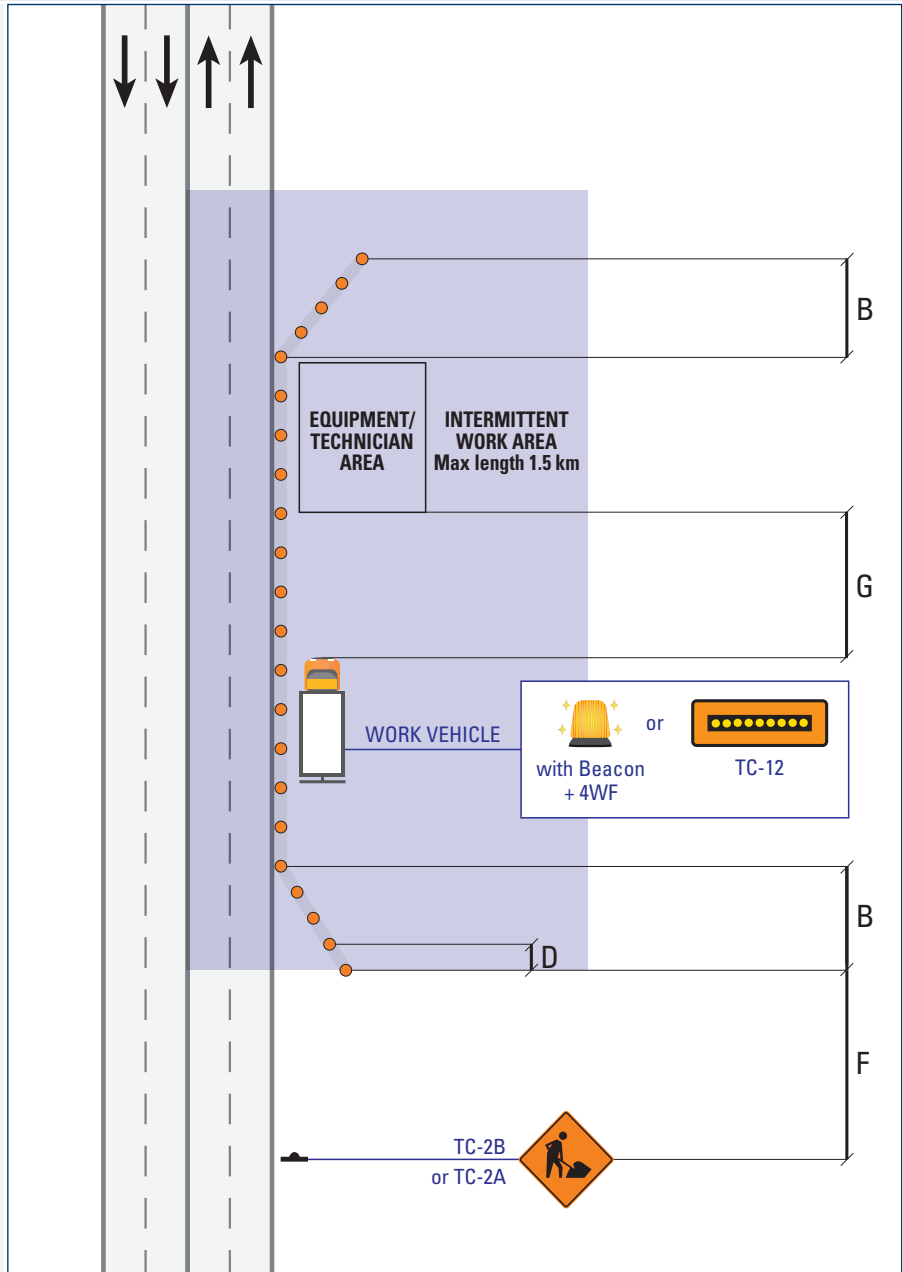

Label	Description	Normal Posted Regulatory Speed (km/h)				
		50	60	70	80	90
<b>B</b>	Shoulder Taper (m)	20	30	55	60	70
<b>D</b>	Maximum Distance between Markers (m)	6	9	9	12	12
	Minimum Number of Markers for Taper	5	7	9	11	13
<b>F</b>	Distance between Construction Signs (m)	50	90	120	140	150
<b>G</b>	Stationary Work (Lateral Intrusion Deterrence Gap (LIDG) (m)	(35)	(40)	50	60	65
<b>H</b>	Sight Distance (m)	150	150	200	250	250

**US-4** **Shoulder Work**

**Multi-Lane Undivided** **Mobile Operations** **Intermittent** **Very Short Duration** Short Duration Long Duration

**NOTES**

- i) Termination Taper optional.
- ii) When a vehicle on shoulder with TC-12 enters a live lane, the TC-12 in bar mode must be switched to arrow mode.

For further detail on Work Zone components, see [Table A \(Mobile/Intermittent/Very Short, pg. 240\)](#).

**With Work Vehicle – Mobile, Intermittent, or VSD**

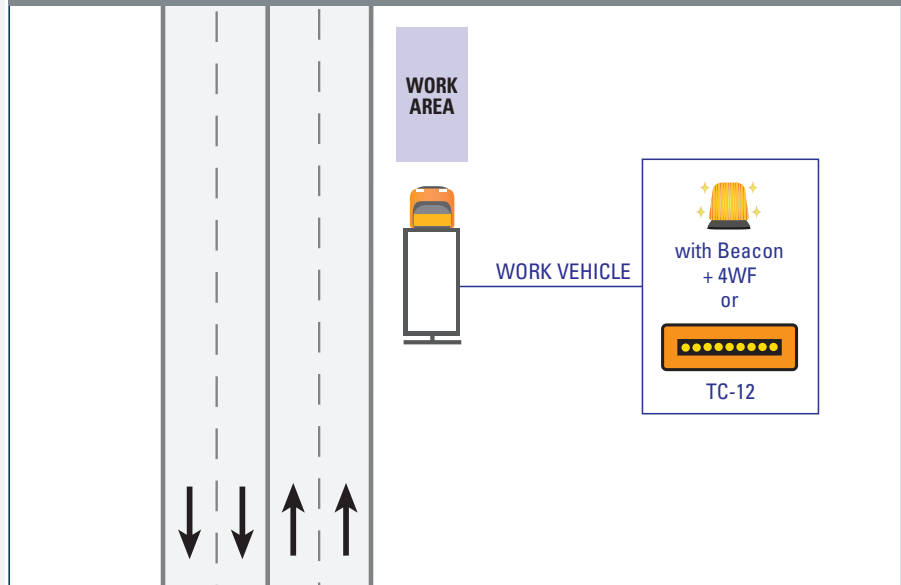

**Without Work Vehicle – VSD**

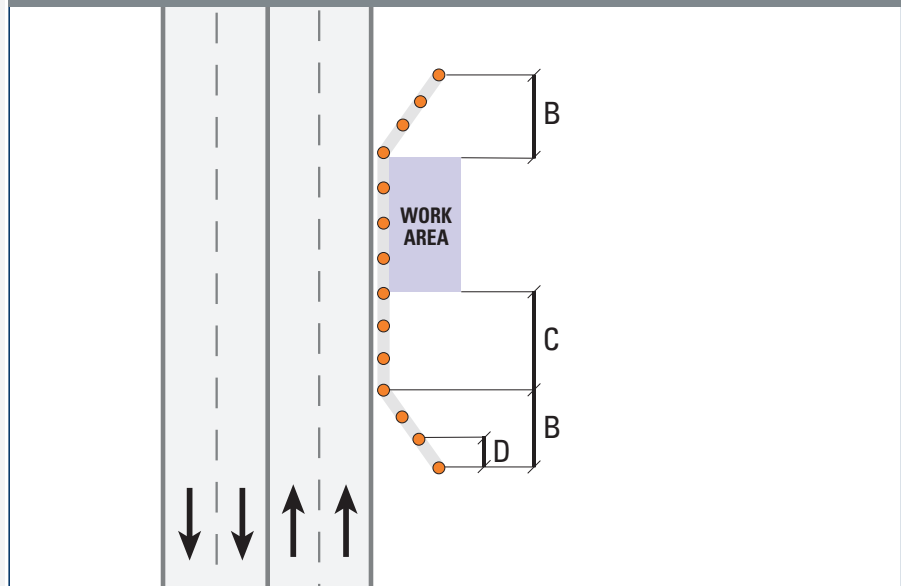

**Normal Posted Regulatory Speed (km/h)**

Label	Description	50	60	70	80	90
<b>B</b>	Shoulder Taper (m)	20	30	35	35	40
<b>C</b>	Longitudinal Buffer Area (LBA) (m)	(30)	(40)	50	60	75
<b>D</b>	Maximum Distance between Markers (m)	6	6	9	9	12
	Minimum Number of Markers for Taper	4	5	5	7	8

**US-5**      **Shoulder Work**

**Multi-Lane Undivided**    Mobile Operations    Intermittent    Very Short Duration    **Short Duration**    Long Duration

**NOTES**

- i) Termination Taper optional.
- ii) Work Area may or may not contain a Work Vehicle. See General Notes to Layouts #4.
- iii) A Work Vehicle with a TC-12 may replace Markers for Short Duration work.

For further detail on Work Zone components, see [Table B \(Short/Long, pg. 241\)](#).

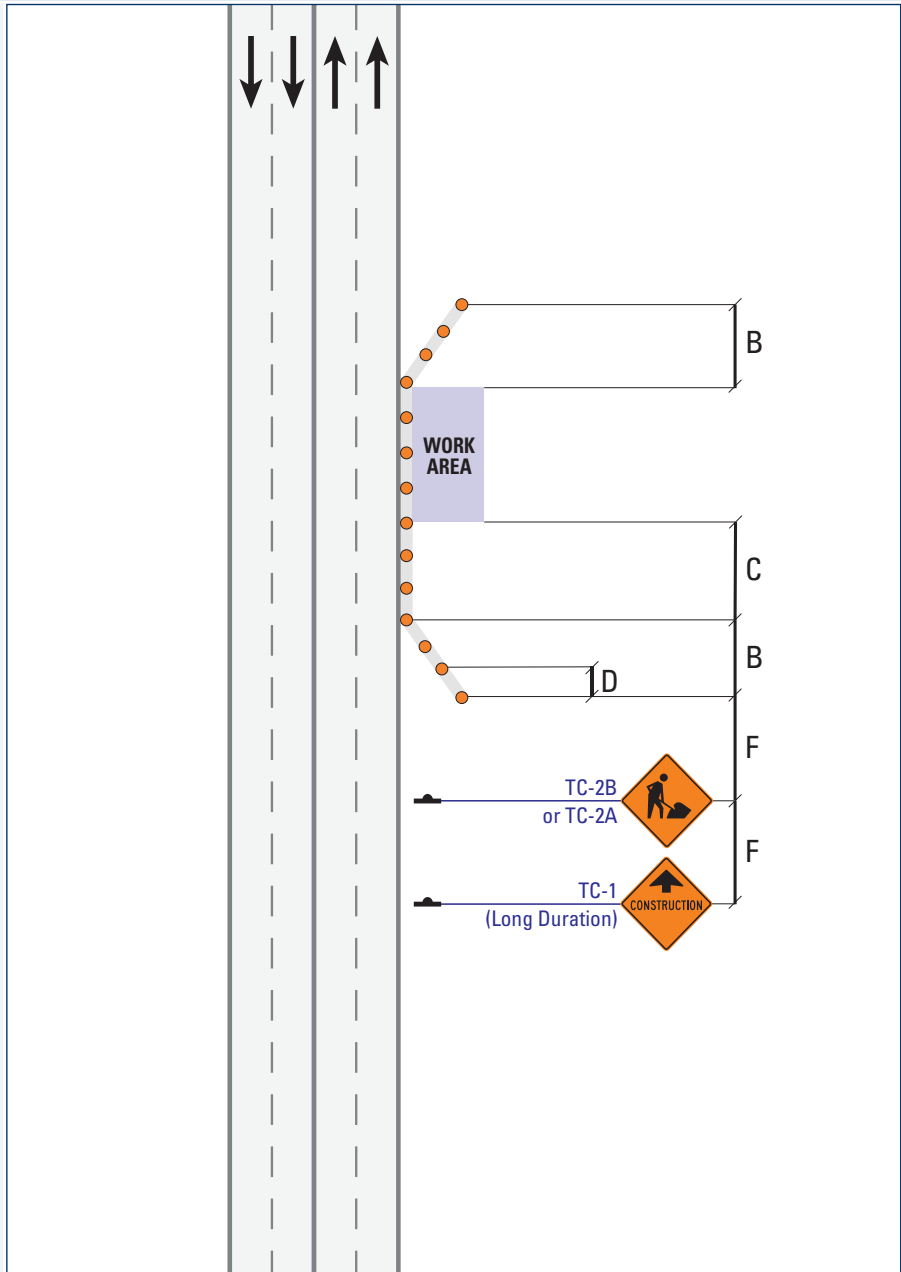

Label	Description	Normal Posted Regulatory Speed (km/h)				
		50	60	70	80	90
<b>B</b>	Shoulder Taper (m)	20	30	55	60	70
<b>C</b>	Longitudinal Buffer Area (LBA) (m)	(30)	(40)	50	60	75
<b>D</b>	Maximum Distance between Markers (m)	6	9	9	12	12
	Minimum Number of Markers for Taper	5	7	9	11	13
<b>F</b>	Distance between Construction Signs (m)	50	90	120	140	150

**US-6 Lane Encroachment**

**Multi-Lane Undivided**   **Mobile Operations**   **Intermittent**   **Very Short Duration**   Short Duration   Long Duration

**NOTES**

- i) Termination Taper optional.
- ii) In addition to the minimum requirement of 3 m temporary lane width, an offset of 0.3 m to 0.6 m between Markers and the edge of the traveled lane is desirable.

For further detail on Work Zone components, see [Table A \(Mobile/Intermittent/Very Short, pg. 240\)](#).

**With Work Vehicle – Mobile, Intermittent, or VSD**

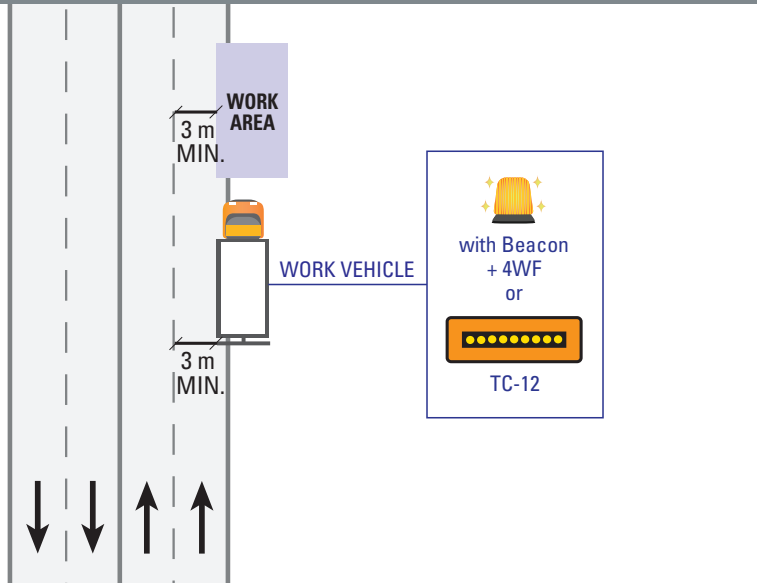

**Without Work Vehicle – VSD**

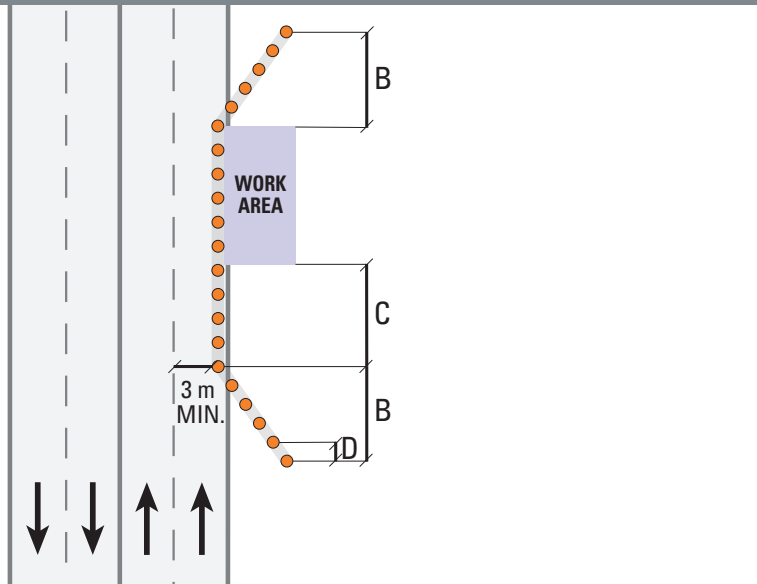

Normal Posted Regulatory Speed (km/h)

Label	Description	50	60	70	80	90
<b>B</b>	Shoulder Taper (m)	20	30	35	35	40
<b>C</b>	Longitudinal Buffer Area (LBA) (m)	(30)	(40)	50	60	75
<b>D</b>	Maximum Distance between Markers (m)	6	6	9	9	12
	Minimum Number of Markers for Taper	4	5	5	7	8

**US-7 Lane Encroachment**

**Multi-Lane Undivided** Mobile Operations Intermittent Very Short Duration **Short Duration** Long Duration

**NOTES**

i) Work Area may or may not contain a Work Vehicle. See General Notes to Layouts #4.

ii) A Work Vehicle with a TC-12 may replace Markers for Short Duration work where NPRS is 60 km/h or lower.

iii) In addition to the minimum requirement of 3 m temporary lane width, an offset of 0.3 m to 0.6 m between Markers and the edge of the traveled lane is desirable.

For further detail on Work Zone components, see [Table B \(Short/Long, pg. 241\)](#).

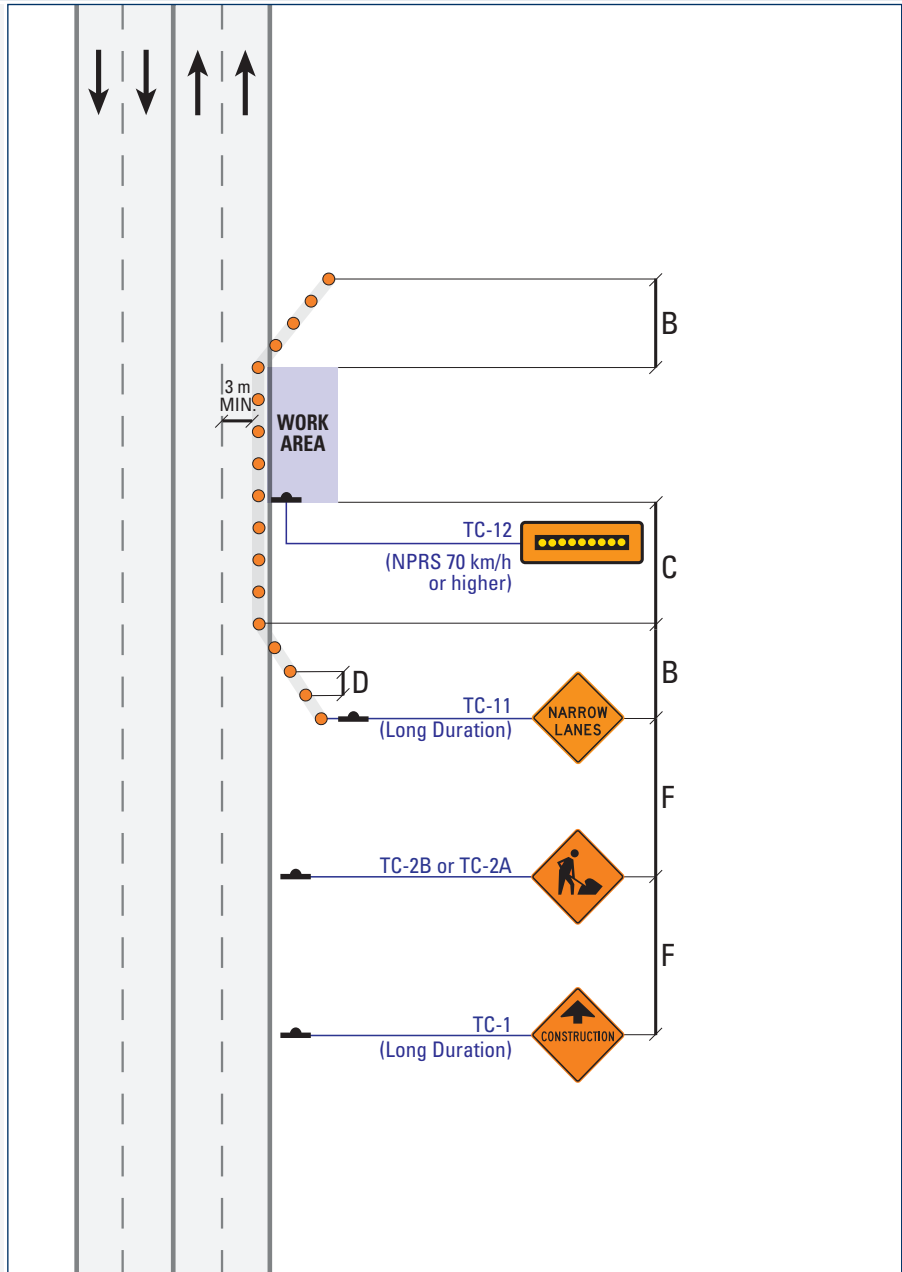

Label	Description	Normal Posted Regulatory Speed (km/h)				
		50	60	70	80	90
<b>B</b>	Shoulder Taper (m)	20	30	55	60	70
<b>C</b>	Longitudinal Buffer Area (LBA) (m)	(30)	(40)	50	60	75
<b>D</b>	Maximum Distance between Markers (m)	6	9	9	12	12
	Minimum Number of Markers for Taper	5	7	9	11	13
<b>F</b>	Distance between Construction Signs (m)	50	90	120	140	150

**US-8** **Parking Lane Closed**

**Multi-Lane Undivided** Mobile Operations Intermittent **Very Short Duration** Short Duration Long Duration

**NOTES**

i) A Work Vehicle with Beacon + 4WF or a TC-12 in bar mode can replace Markers.

For further detail on Work Zone components, see [Table A \(Mobile/Intermittent/Very Short, pg. 240\)](#).

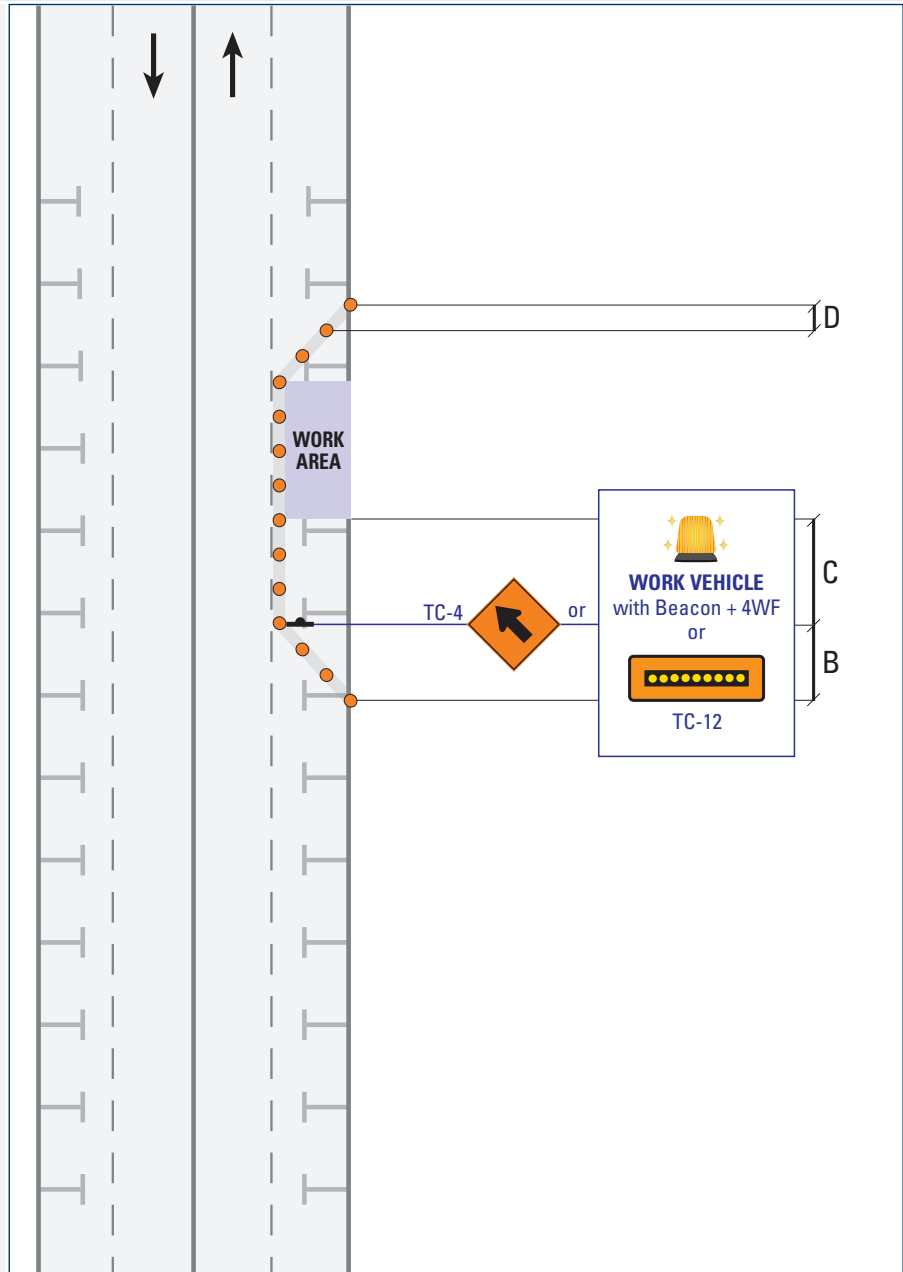

Label	Description	Normal Posted Regulatory Speed (km/h)			
		50	60	70	80
<b>B</b>	Shoulder Taper (m)	20	30	35	35
<b>C</b>	Longitudinal Buffer Area (LBA) (m)	(30)	(40)	50	60
<b>D</b>	Maximum Distance between Markers (m)	6	6	9	9
	Minimum Number of Markers for Taper	4	5	5	7

**US-9** **Parking Lane Closed**

**Multi-Lane Undivided** Mobile Operations Intermittent Very Short Duration **Short Duration** Long Duration

**NOTES**

- i) Placement of TC-1 or TC-2 may need to be adjusted if visibility is obstructed due to parked vehicles.
- ii) For Short Duration work, a Work Vehicle with Beacon + 4WF or a TC-12 in bar mode can replace Markers.

For further detail on Work Zone components, see [Table B \(Short/Long, pg. 241\)](#).

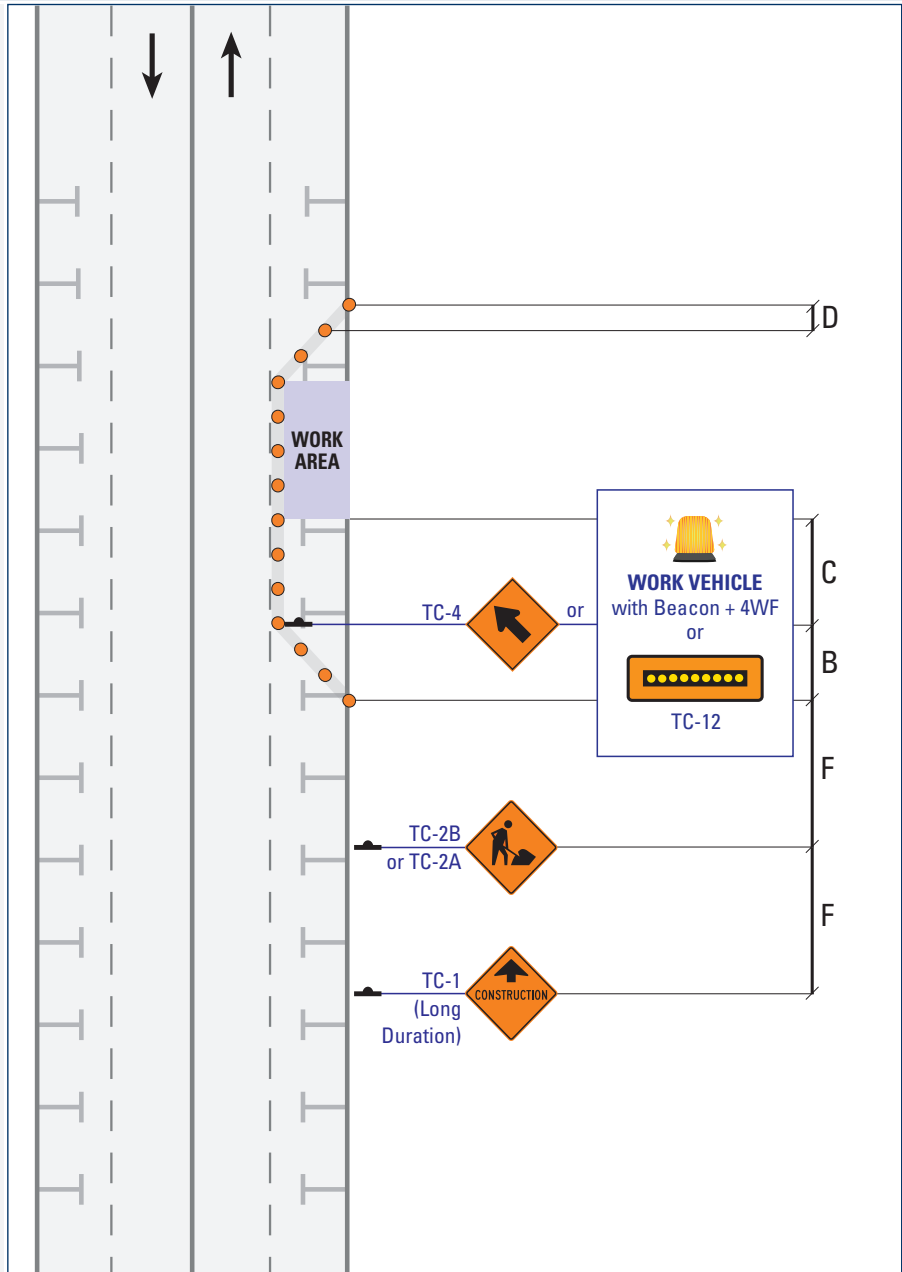

Label	Description	Normal Posted Regulatory Speed (km/h)			
		50	60	70	80
<b>B</b>	Shoulder Taper (m)	20	30	55	60
<b>C</b>	Longitudinal Buffer Area (LBA) (m)	(30)	(40)	50	60
<b>D</b>	Maximum Distance between Markers (m)	6	9	9	12
	Minimum Number of Markers for Taper	5	7	9	11
<b>F</b>	Distance between Construction Signs (m)	50	90	120	140

**US-10** Partial Lane Shift: Narrow Lanes

**Multi-Lane Undivided** Mobile Operations Intermittent Very Short Duration Short Duration Long Duration

**NOTES**

i) Minimum lane width is 3 m. Additionally, an offset of 0.3 m to 0.6 m between Markers and the edge of the traveled lane is desirable.

ii) For narrowed lanes exceeding 2 km, use a TC-16EL (ER) in place of the TC-9L (R). Add an additional TC-16ER (EL) at the beginning of end Taper.

For further detail on Work Zone components, see [Table B \(Short/Long, pg. 241\)](#).

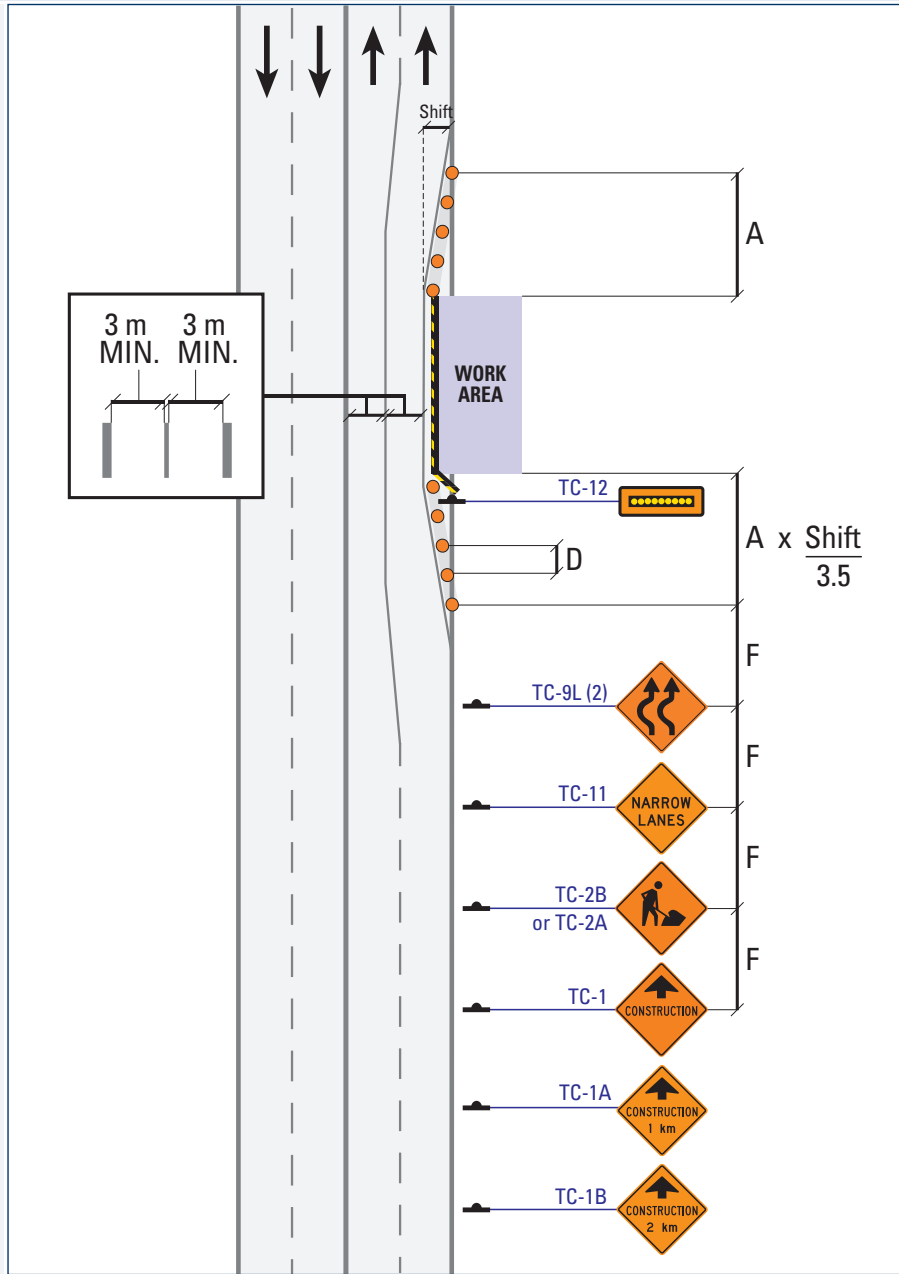

Normal Posted Regulatory Speed (km/h)

Label	Description	50	60	70	80	90
<b>A</b>	Taper Length for Full Lane Closure (m)	60	85	155	180	200
<b>D</b>	Maximum Distance between Markers (m)	6	9	9	12	12
	Minimum Number of Markers for Taper	5	7	9	11	13
<b>F</b>	Distance between Construction Signs (m)	50	90	120	140	150



**US-11 Lane Realignment**

**Multi-Lane Undivided** Mobile Operations Intermittent Very Short Duration Short Duration Long Duration

**NOTES**

i) Refer to OTM Book 6 for the appropriate placement of TC-18L.

ii) Markers used for additional Delineation through Tangent on the far-side of the Work Area are optional.

For further detail on Work Zone components, see [Table B \(Short/Long, pg. 241\)](#).

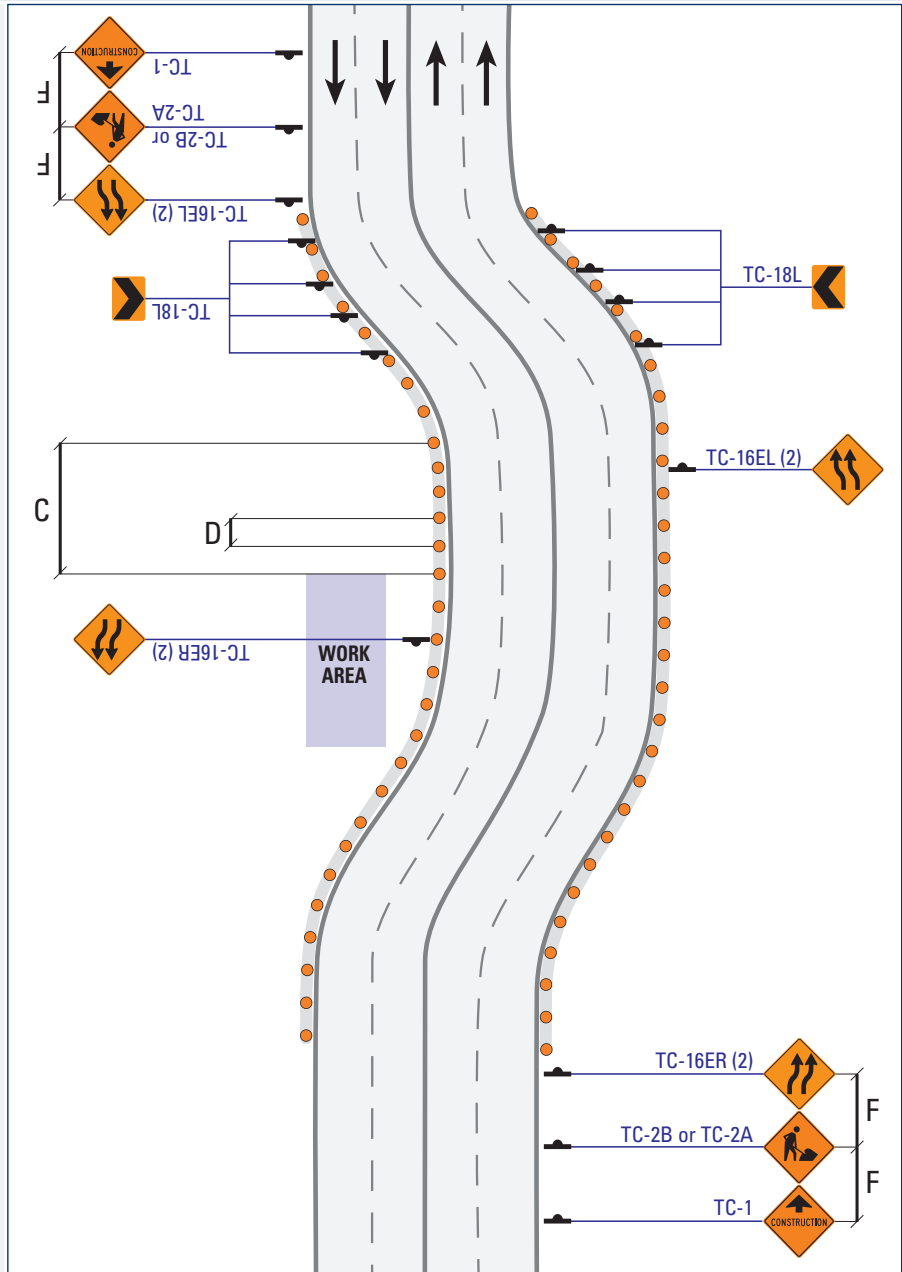

Label	Description	Normal Posted Regulatory Speed (km/h)				
		50	60	70	80	90
<b>C</b>	Longitudinal Buffer Area (LBA) (m)	(30)	(40)	50	60	75
<b>D</b>	Maximum Distance between Markers (m)	6	9	9	12	12
	Minimum Number of Markers for Taper	5	7	9	11	13
<b>F</b>	Distance between Construction Signs (m)	50	90	120	140	150

**US-12 Zone Painting: Right or Left Lane Closed**

**Multi-Lane Undivided Mobile Operations** Intermittent Very Short Duration Short Duration Long Duration

**NOTES**

- i) MTO requirements illustrated. Other Road Authorities may not require a "ROAD PAINTING" information sign.
- ii) Sign Truck may be replaced by an approved equivalent VMS.
- iii) Where shoulder is intermittent, Sign Truck should drive with traffic flow in arrow mode until shoulder becomes available.
- iv) Left Lane Closed mirror image, but the Sign Truck should follow behind, in the same lane as the Buffer Vehicle.
- v) The distance between Sign Truck and Buffer Vehicle may be adjusted to accommodate hills, curves, restricted visibility, or other specific conditions.

For further detail on Work Zone components, see [Table A \(Mobile/Intermittent/Very Short, pg. 240\)](#).

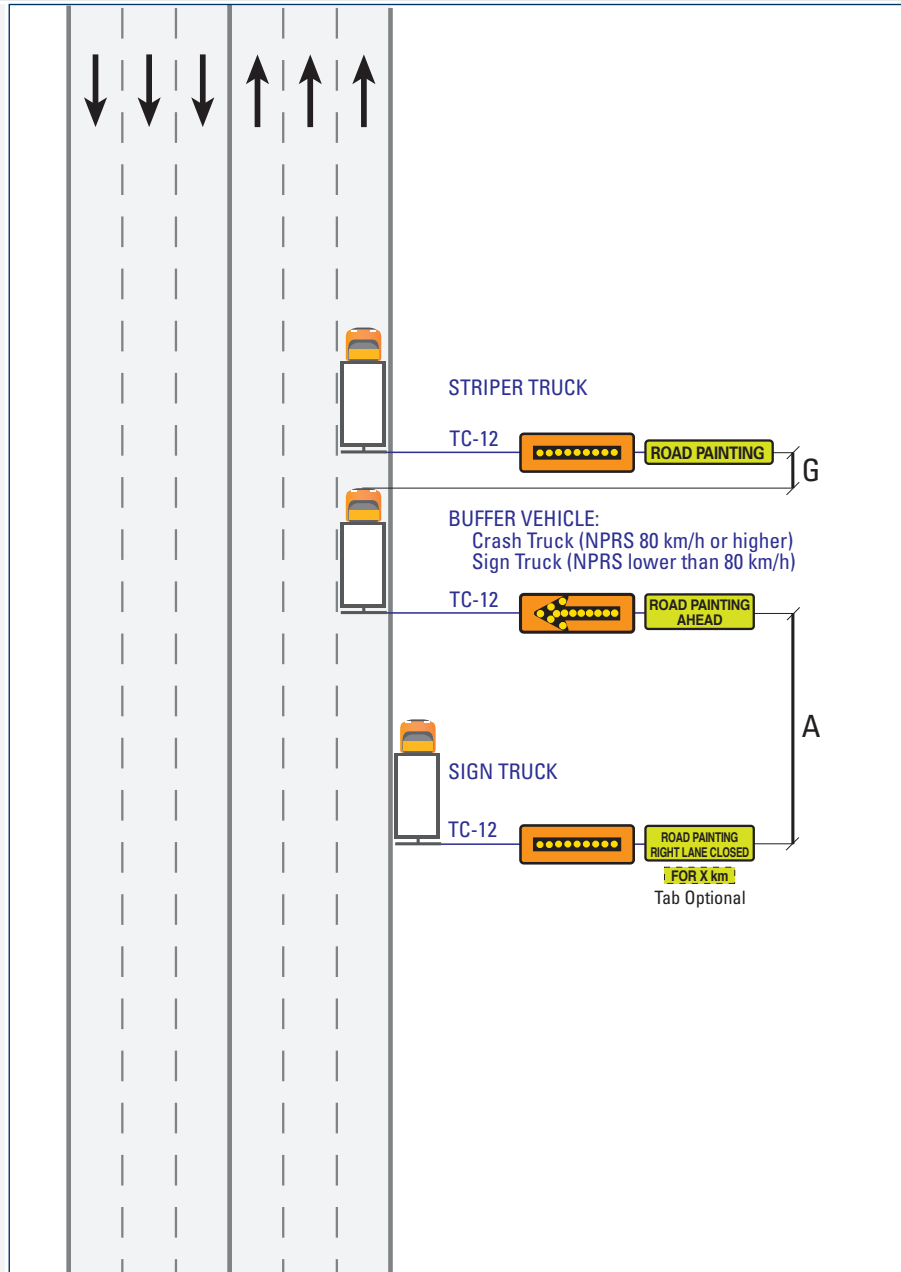

**Normal Posted Regulatory Speed (km/h)**

Label	Description	Normal Posted Regulatory Speed (km/h)				
		50	60	70	80	90
<b>A</b>	Taper Length for Full Lane Closure (m)	60	85	100	100	110
<b>G</b>	Mobile Work: Lateral Intrusion Deterrence Gap (LIDG) (m)	–	–	35	45	50

**US-13 Lane Closed or Occupied**

**Multi-Lane Undivided**    **Mobile Operations**    **Intermittent**    **Very Short Duration**    Short Duration    Long Duration

**NOTES**

i) Distance between Sign Truck and Work Vehicle may be adjusted to accommodate hills, curves, restricted visibility, or other site specific conditions.

ii) Where shoulder is intermittent, Sign Truck should drive with traffic flow until shoulder becomes available.

iii) Left Lane Closed, see US-14.

For further detail on Work Zone components, see [Table A \(Mobile/Intermittent/Very Short, pg. 240\)](#).

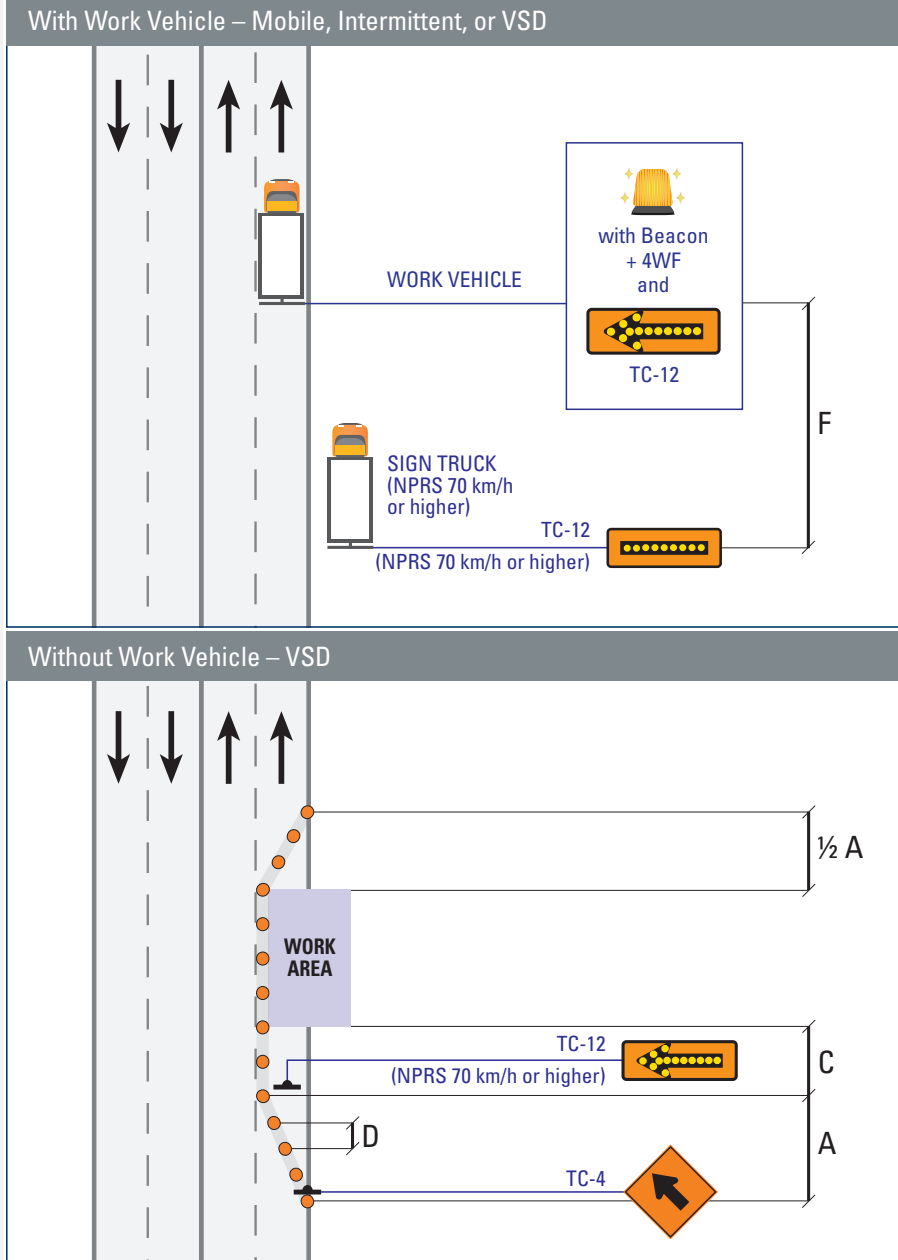

Label	Description	Normal Posted Regulatory Speed (km/h)				
		50	60	70	80	90
<b>A</b>	Taper Length for Full Lane Closure (m)	60	85	100	100	110
<b>C</b>	Longitudinal Buffer Area (LBA) (m)	(30)	(40)	50	60	75
<b>D</b>	Maximum Distance between Markers (m)	6	6	9	9	12
	Minimum Number of Markers for Taper	4	5	5	7	8
<b>F</b>	Distance between Construction Signs (m)	30	30	60	60	80

**US-14** **Left Lane Closed or Occupied**

**Multi-Lane Undivided** **Mobile Operations** **Intermittent** **Very Short Duration** Short Duration Long Duration

**NOTES**

i) Distance between Sign Truck and Work Vehicle may be adjusted to accommodate hills, curves, restricted visibility, or other site specific conditions.

\*The TC-4 sign must be installed at or just beyond the beginning of a lane closure taper.

For further detail on Work Zone components, see [Table A \(Mobile/Intermittent/Very Short, pg. 240\)](#).

**With Work Vehicle – Mobile, Intermittent, or VSD**

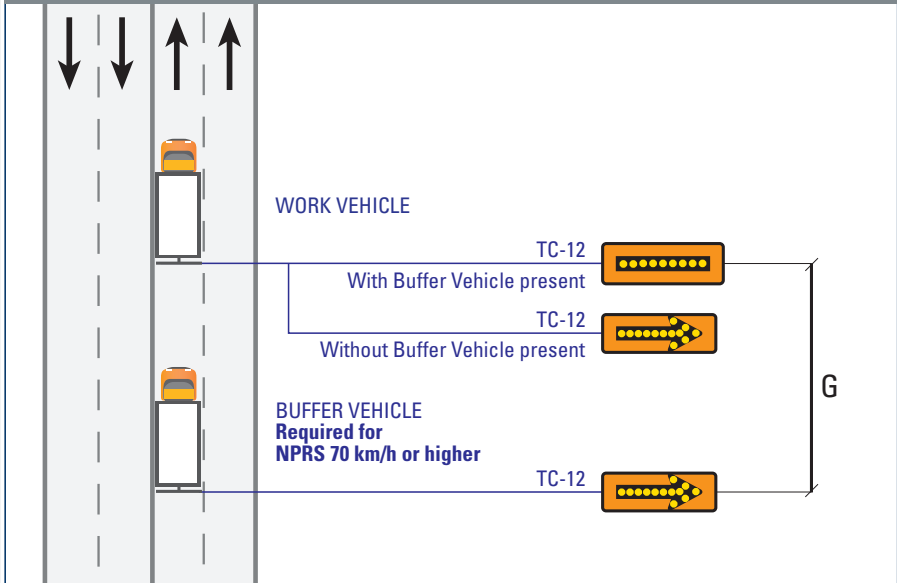

**Without Work Vehicle – VSD**

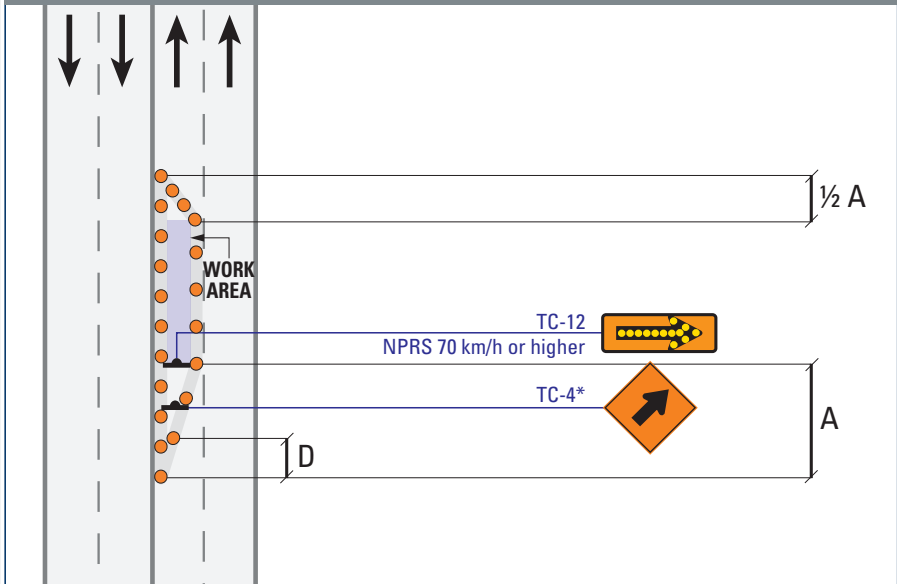

Normal Posted Regulatory Speed (km/h)

Label	Description	50	60	70	80	90
<b>A</b>	Taper Length for Full Lane Closure (m)	60	85	100	100	110
<b>D</b>	Maximum Distance between Markers (m)	6	6	9	9	12
	Minimum Number of Markers for Taper	4	5	5	7	8
<b>G</b>	Mobile Work: Lateral Intrusion Deterrence Gap (LIDG) (m)	–	–	35	45	50

**US-15** Two-Way Left Turn Lane Closed

**Multi-Lane Undivided** Mobile Operations Intermittent **Very Short Duration** Short Duration Long Duration

**NOTES**

i) Where TC-12 is used and the NPRS is 60 km/h or lower, Markers are not required.

For further detail on Work Zone components, see [Table A \(Mobile/Intermittent/Very Short, pg. 240\)](#).

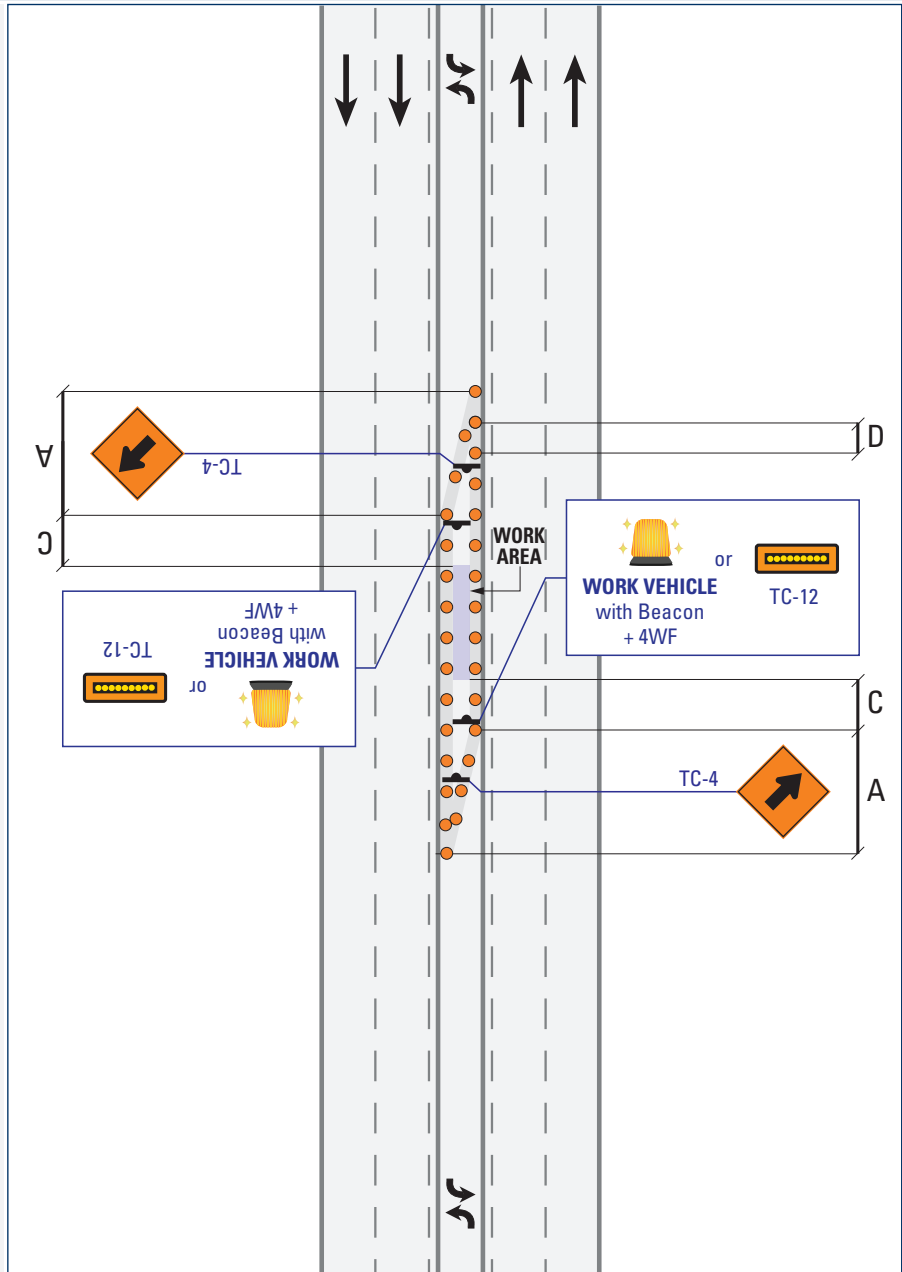

Label	Description	Normal Posted Regulatory Speed (km/h)				
		50	60	70	80	90
<b>A</b>	Taper Length for Full Lane Closure (m)	60	85	100	100	110
<b>C</b>	Longitudinal Buffer Area (LBA) (m)	(30)	(40)	50	60	75
<b>D</b>	Maximum Distance between Markers (m)	6	6	9	9	12
Minimum Number of Markers for Taper		4	5	5	7	8

**US-16 Two-Way Left Turn Lane Closed**

**Multi-Lane Undivided** Mobile Operations Intermittent Very Short Duration **Short Duration** Long Duration

**NOTES**

For further detail on Work Zone components, see [Table B \(Short/Long, pg. 241\)](#).

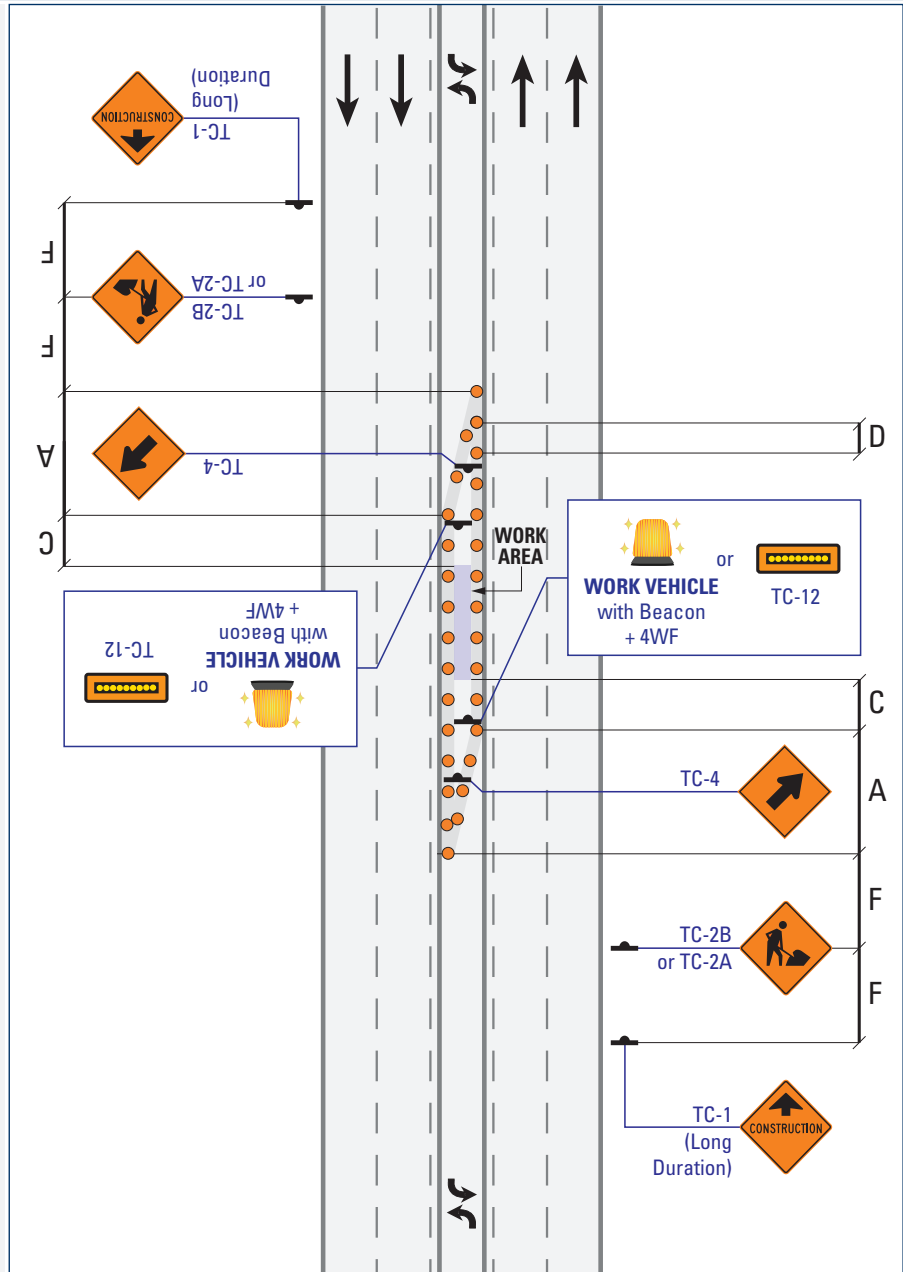

Normal Posted Regulatory Speed (km/h)

Label	Description	50	60	70	80	90
<b>A</b>	Taper Length for Full Lane Closure (m)	60	85	155	180	200
<b>C</b>	Longitudinal Buffer Area (LBA) (m)	(30)	(40)	50	60	75
<b>D</b>	Maximum Distance between Markers (m)	6	9	9	12	12
	Minimum Number of Markers for Taper	5	7	9	11	13
<b>F</b>	Distance between Construction Signs (m)	50	90	120	140	150

**US-17 Lane Closed**

**Multi-Lane Undivided** Mobile Operations Intermittent Very Short Duration **Short Duration** Long Duration

**NOTES**

i) For Left Lane Closed Undivided or with no shoulder, see US-18.

For further detail on Work Zone components, see [Table B \(Short/Long, pg. 241\)](#).

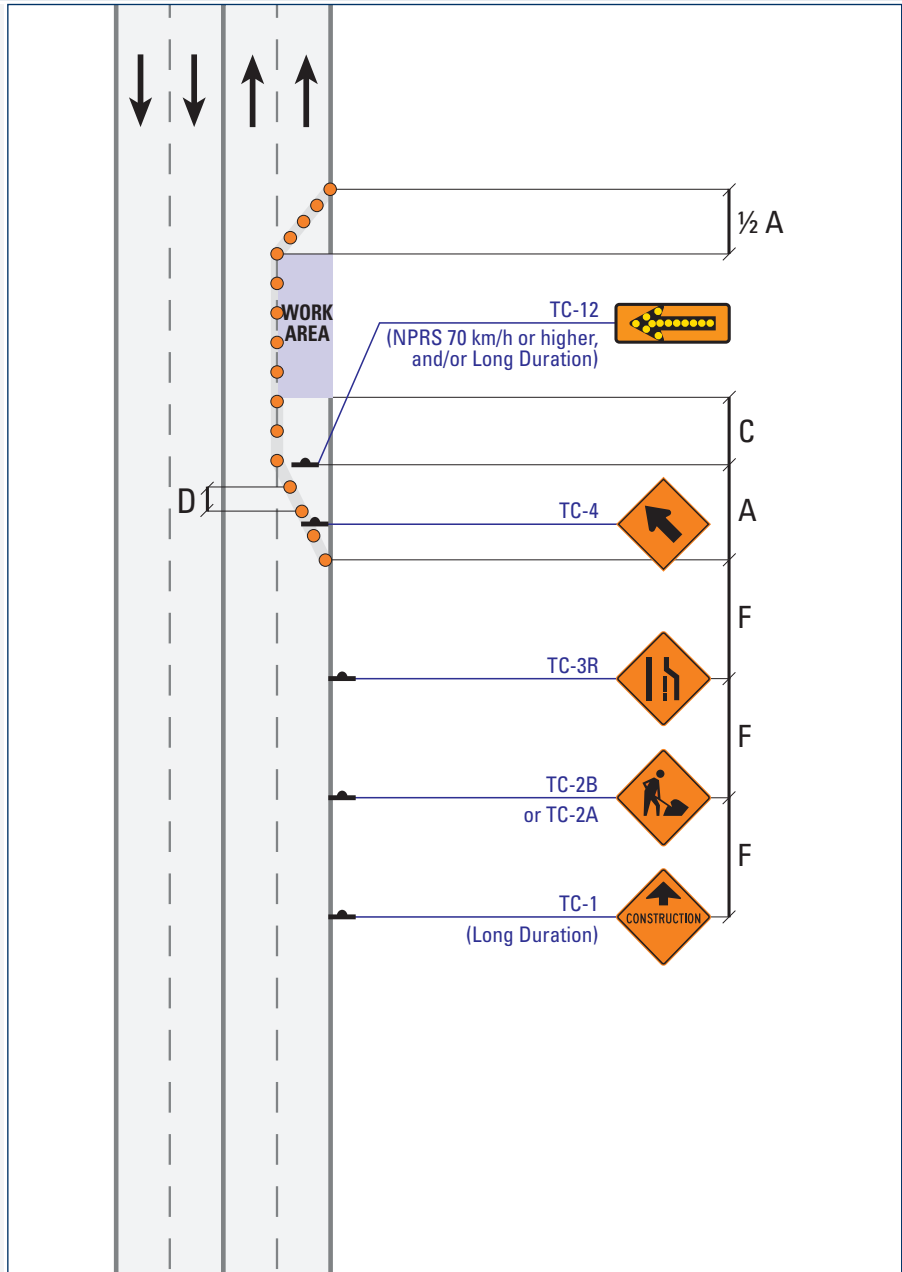

Label	Description	Normal Posted Regulatory Speed (km/h)				
		50	60	70	80	90
<b>A</b>	Taper Length for Full Lane Closure (m)	60	85	155	180	200
<b>C</b>	Longitudinal Buffer Area (LBA) (m)	(30)	(40)	50	60	75
<b>D</b>	Maximum Distance between Markers (m)	6	9	9	12	12
	Minimum Number of Markers for Taper	5	7	9	11	13
<b>F</b>	Distance between Construction Signs (m)	50	90	120	140	150

**US-18** **Left Lane Closed**

**Multi-Lane Undivided** Mobile Operations Intermittent Very Short Duration **Short Duration** Long Duration

**NOTES**

For further detail on Work Zone components, see [Table B \(Short/Long, pg. 241\)](#).

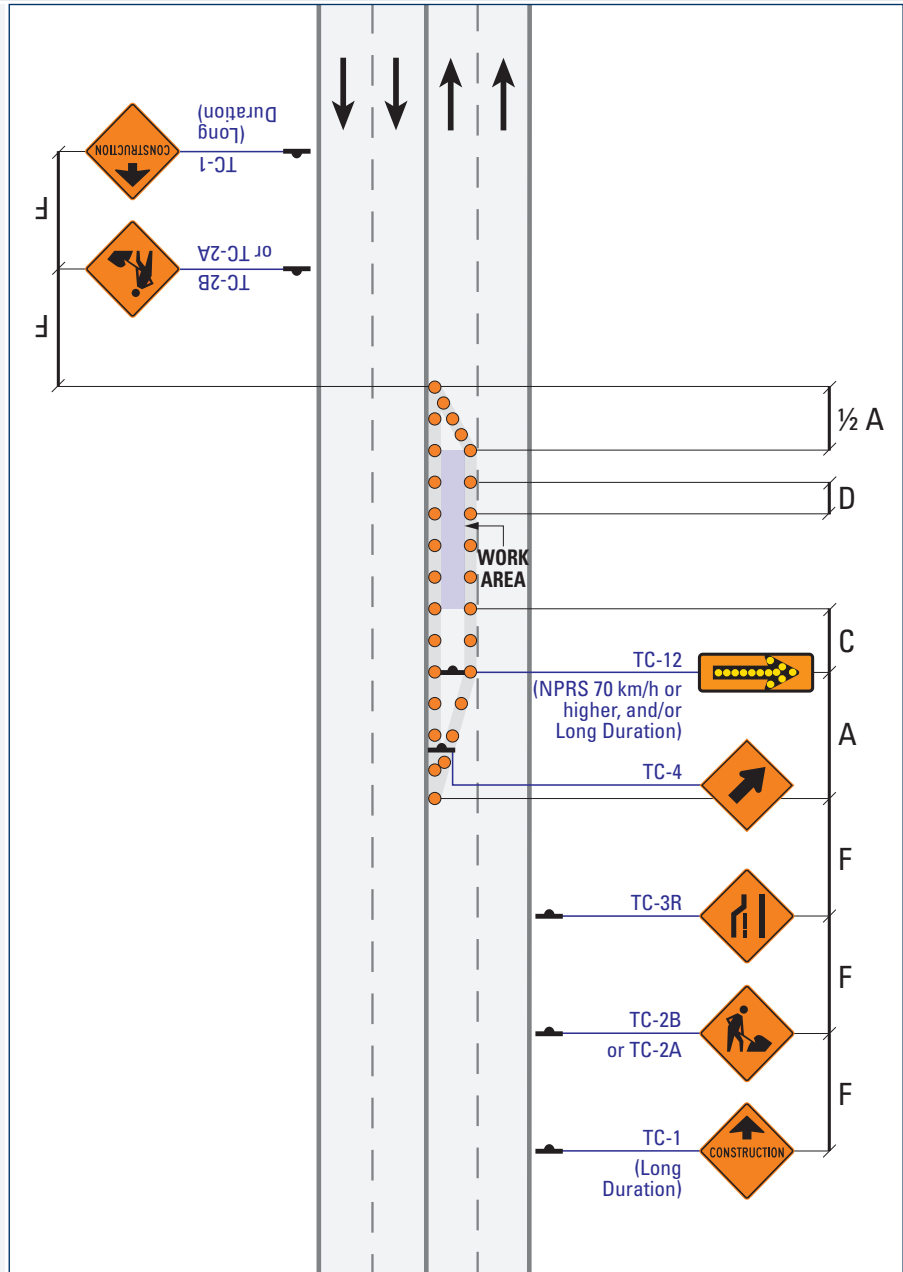

Normal Posted Regulatory Speed (km/h)

Label	Description	50	60	70	80	90
<b>A</b>	Taper Length for Full Lane Closure (m)	60	85	155	180	200
<b>C</b>	Longitudinal Buffer Area (LBA) (m)	(30)	(40)	50	60	75
<b>D</b>	Maximum Distance between Markers (m)	6	9	9	12	12
	Minimum Number of Markers for Taper	5	7	9	11	13
<b>F</b>	Distance between Construction Signs (m)	50	90	120	140	150



**US-19** **Passing Lanes: Single-Lane Direction Closed**

**Multi-Lane Undivided** Mobile Operations Intermittent Very Short Duration **Short Duration** Long Duration

**NOTES**

i) The added lane should be allowed to redevelop only if there is sufficient remaining lane length to permit safe passing.

ii) For High Volume roads or Long Duration work longer than five days, the use of Temporary Concrete Barriers should be considered to separate opposing traffic.

iii) For diversions exceeding 1 km, use a TC-16EL (ER) in place of the TC-9L (R), and add an additional TC-16ER (EL) at the beginning of end Taper.

For further detail on Work Zone components, see [Table B \(Short/Long, pg. 241\)](#).

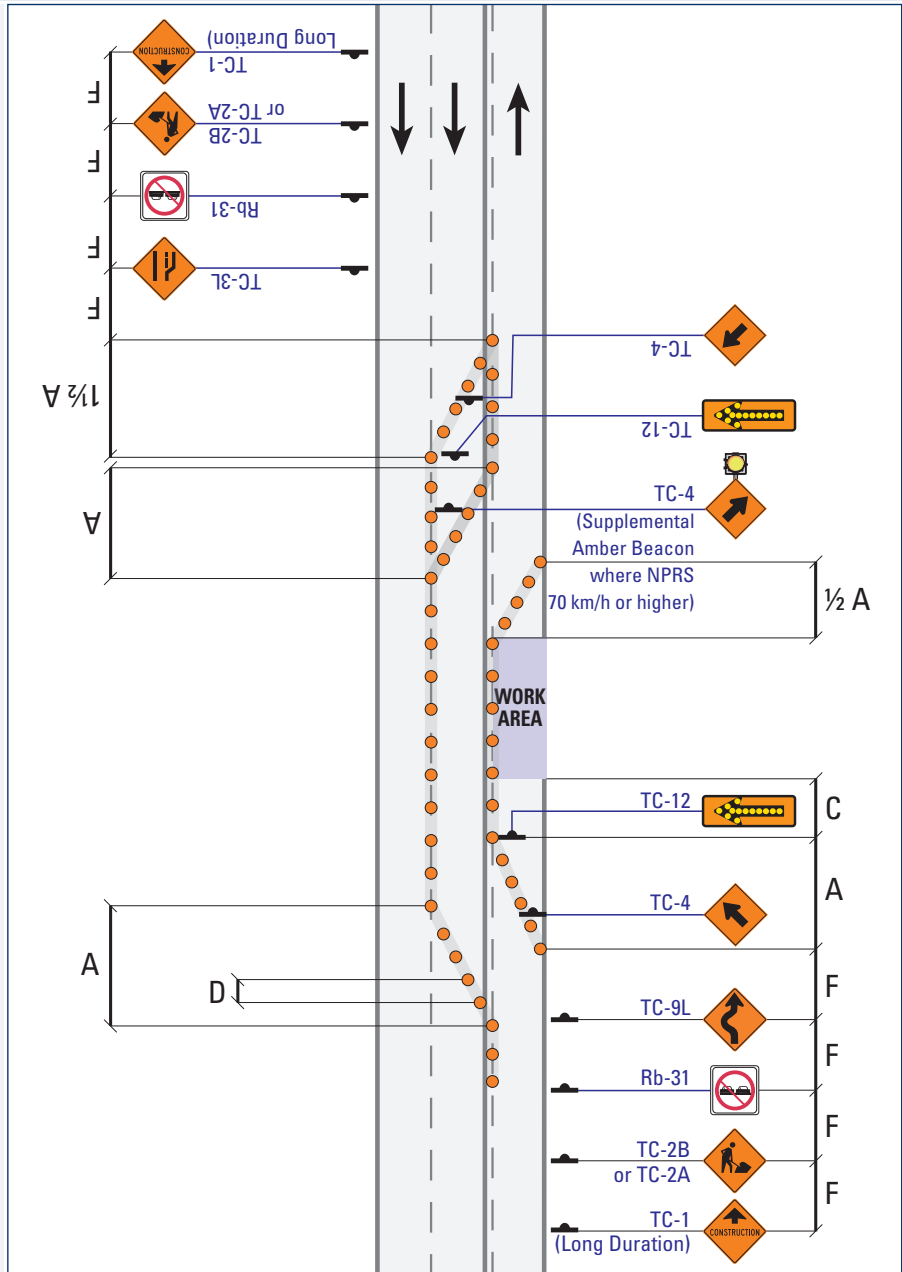

Label	Description	Normal Posted Regulatory Speed (km/h)				
		50	60	70	80	90
<b>A</b>	Taper Length for Full Lane Closure (m)	60	85	155	180	200
<b>C</b>	Longitudinal Buffer Area (LBA) (m)	(30)	(40)	50	60	75
<b>D</b>	Maximum Distance between Markers (m)	6	9	9	12	12
	Minimum Number of Markers for Taper	5	7	9	11	13
<b>F</b>	Distance between Construction Signs (m)	50	90	120	140	150

**US-20** **Passing Lanes: Centre Lane Closed**

**Multi-Lane Undivided** Mobile Operations Intermittent Very Short Duration **Short Duration** Long Duration

**NOTES**

i) For High Volume roads or Long Duration work longer than five days, the use of Temporary Concrete Barriers should be considered to separate opposing traffic.

For further detail on Work Zone components, see [Table B \(Short/Long, pg. 241\)](#).

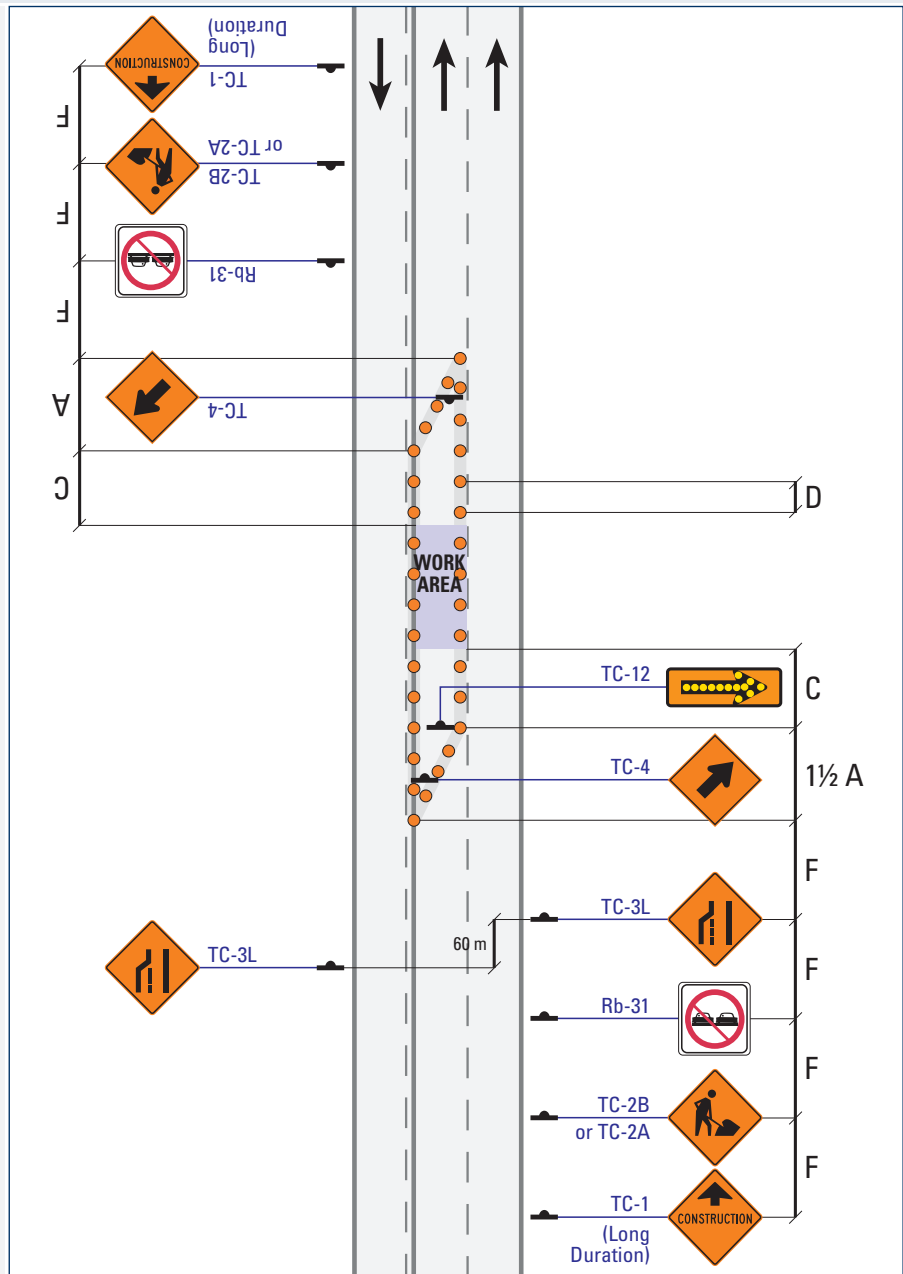

Normal Posted Regulatory Speed (km/h)

Label	Description	50	60	70	80	90
<b>A</b>	Taper Length for Full Lane Closure (m)	60	85	155	180	200
<b>C</b>	Longitudinal Buffer Area (LBA) (m)	(30)	(40)	50	60	75
<b>D</b>	Maximum Distance between Markers (m)	6	9	9	12	12
	Minimum Number of Markers for Taper	5	7	9	11	13
<b>F</b>	Distance between Construction Signs (m)	50	90	120	140	150

**US-21 Four Lane Road: Two Lanes Closed**

**Multi-Lane Undivided**

Mobile Operations

Intermittent

Very Short Duration

Short Duration

Long Duration

**NOTES**

i) For High Volume roads or Long Duration work longer than five days, the use of Temporary Concrete Barriers should be considered to separate opposing traffic.

ii) For diversions exceeding 1 km, use a TC-16EL (ER) in place of the TC-9L (R), and add an additional TC-16ER (EL) at the beginning of end Taper.

For further detail on Work Zone components, see [Table B \(Short/Long, pg. 241\)](#).

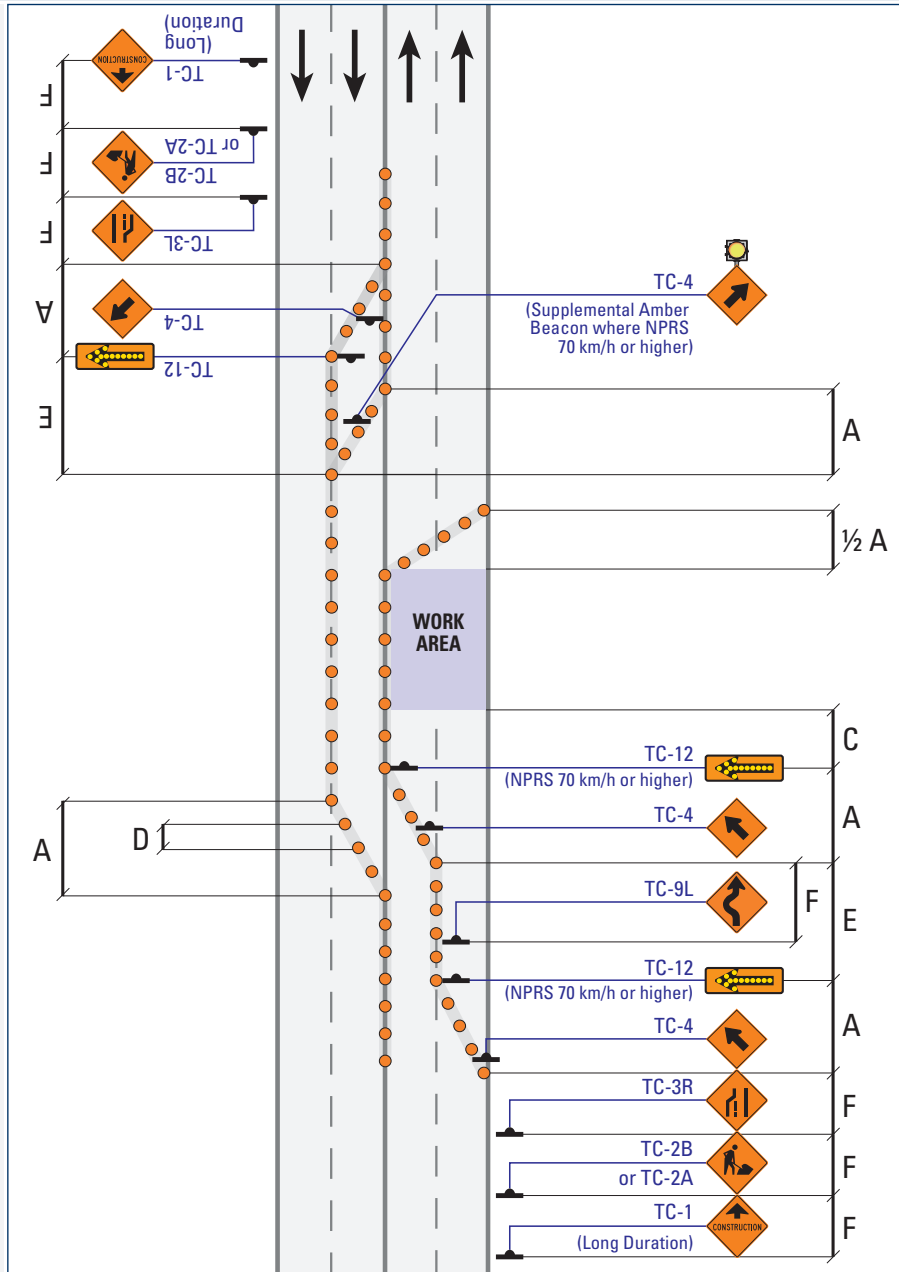

Label	Description	Normal Posted Regulatory Speed (km/h)				
		50	60	70	80	90
<b>A</b>	Taper Length for Full Lane Closure (m)	60	85	155	180	200
<b>C</b>	Longitudinal Buffer Area (LBA) (m)	(30)	(40)	50	60	75
<b>D</b>	Maximum Distance between Markers (m)	6	9	9	12	12
	Minimum Number of Markers for Taper	5	7	9	11	13
<b>E</b>	Minimum Tangent between Tapers (m)	60	85	155	180	200
<b>F</b>	Distance between Construction Signs (m)	50	90	120	140	150

**US-22** **Five Lane Road: Two Through Lanes Closed**

**Multi-Lane Undivided** Mobile Operations Intermittent Very Short Duration **Short Duration** Long Duration

**NOTES**

i) For diversions, exceeding 1 km, use a TC-16 EL (ER) in place of the TC-9L (R) and add an additional TC-16 ER (EL) at the beginning of end Taper.

For further detail on Work Zone components, see [Table B \(Short/Long, pg. 241\)](#).

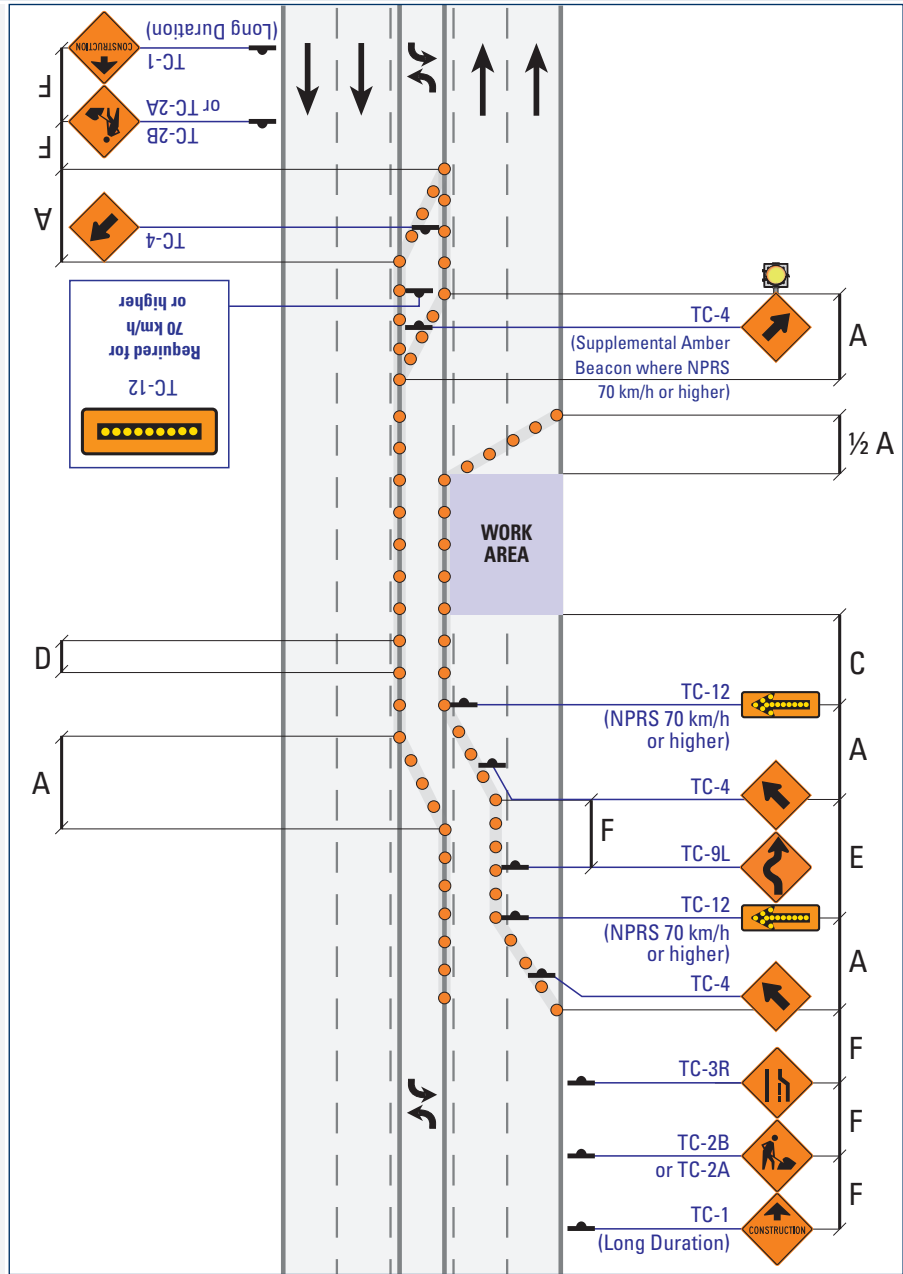

Normal Posted Regulatory Speed (km/h)

Label	Description	50	60	70	80	90
<b>A</b>	Taper Length for Full Lane Closure (m)	60	85	155	180	200
<b>C</b>	Longitudinal Buffer Area (LBA) (m)	(30)	(40)	50	60	75
<b>D</b>	Maximum Distance between Markers (m)	6	9	9	12	12
	Minimum Number of Markers for Taper	5	7	9	11	13
<b>E</b>	Minimum Tangent between Tapers (m)	60	85	155	180	200
<b>F</b>	Distance between Construction Signs (m)	50	90	120	140	150

**US-23** Five Lane Road: Through Lane and Left Turn Lane Closed

Multi-Lane Undivided Mobile Operations Intermittent Very Short Duration Short Duration Long Duration

**NOTES**

For further detail on Work Zone components, see [Table B \(Short/Long, pg. 241\)](#).

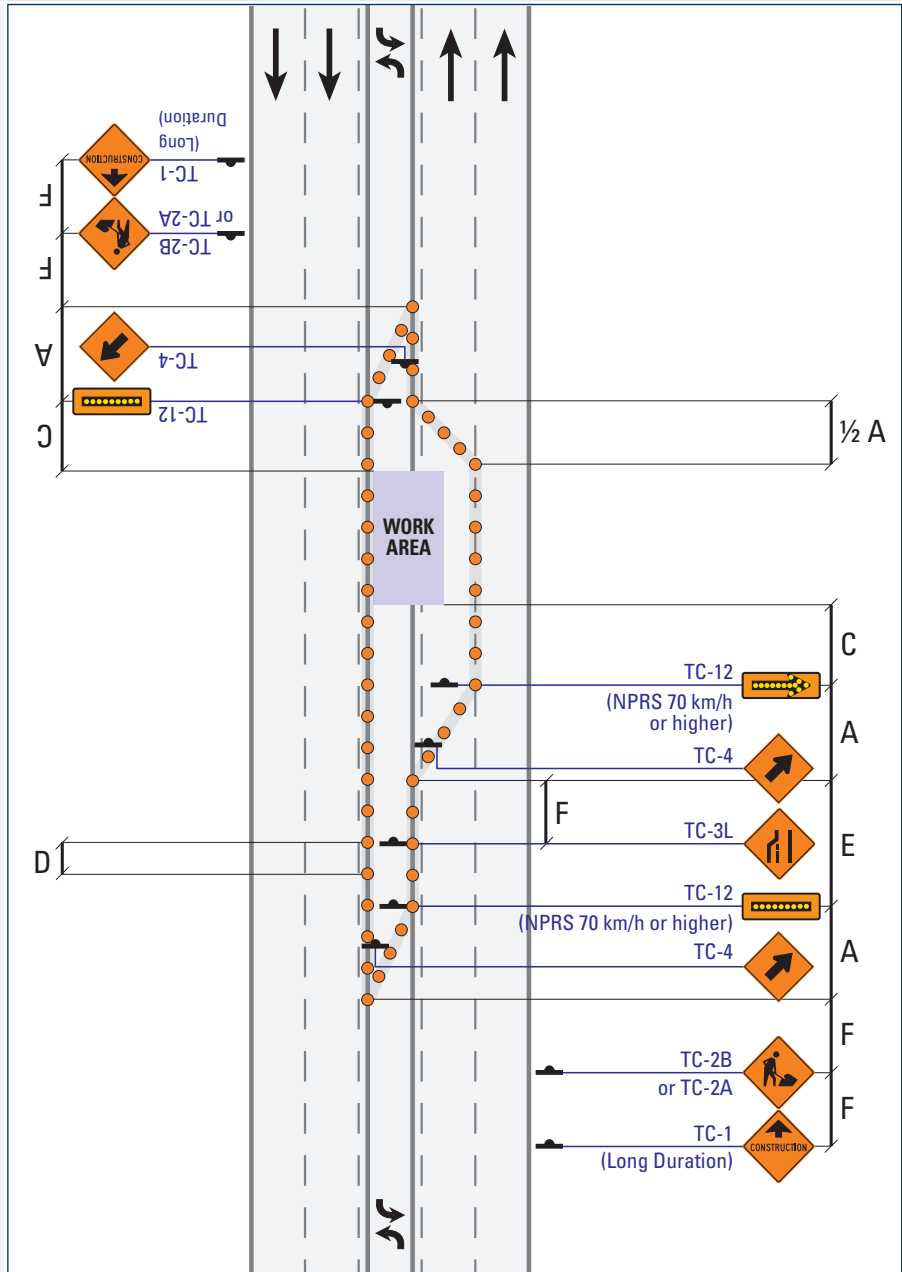

Label	Description	Normal Posted Regulatory Speed (km/h)				
		50	60	70	80	90
<b>A</b>	Taper Length for Full Lane Closure (m)	60	85	155	180	200
<b>C</b>	Longitudinal Buffer Area (LBA) (m)	(30)	(40)	50	60	75
<b>D</b>	Maximum Distance between Markers (m)	6	9	9	12	12
	Minimum Number of Markers for Taper	5	7	9	11	13
<b>E</b>	Minimum Tangent between Tapers (m)	60	85	155	180	200
<b>F</b>	Distance between Construction Signs (m)	50	90	120	140	150

**US-24** Six Lane Road: Left Two Lanes Closed

**Multi-Lane Undivided** Mobile Operations Intermittent Very Short Duration Short Duration Long Duration

**NOTES**

i) Right Lanes Closed: mirror image, except for TC-3, TC-2, and TC-1.

For further detail on Work Zone components, see [Table B \(Short/Long, pg. 241\)](#).

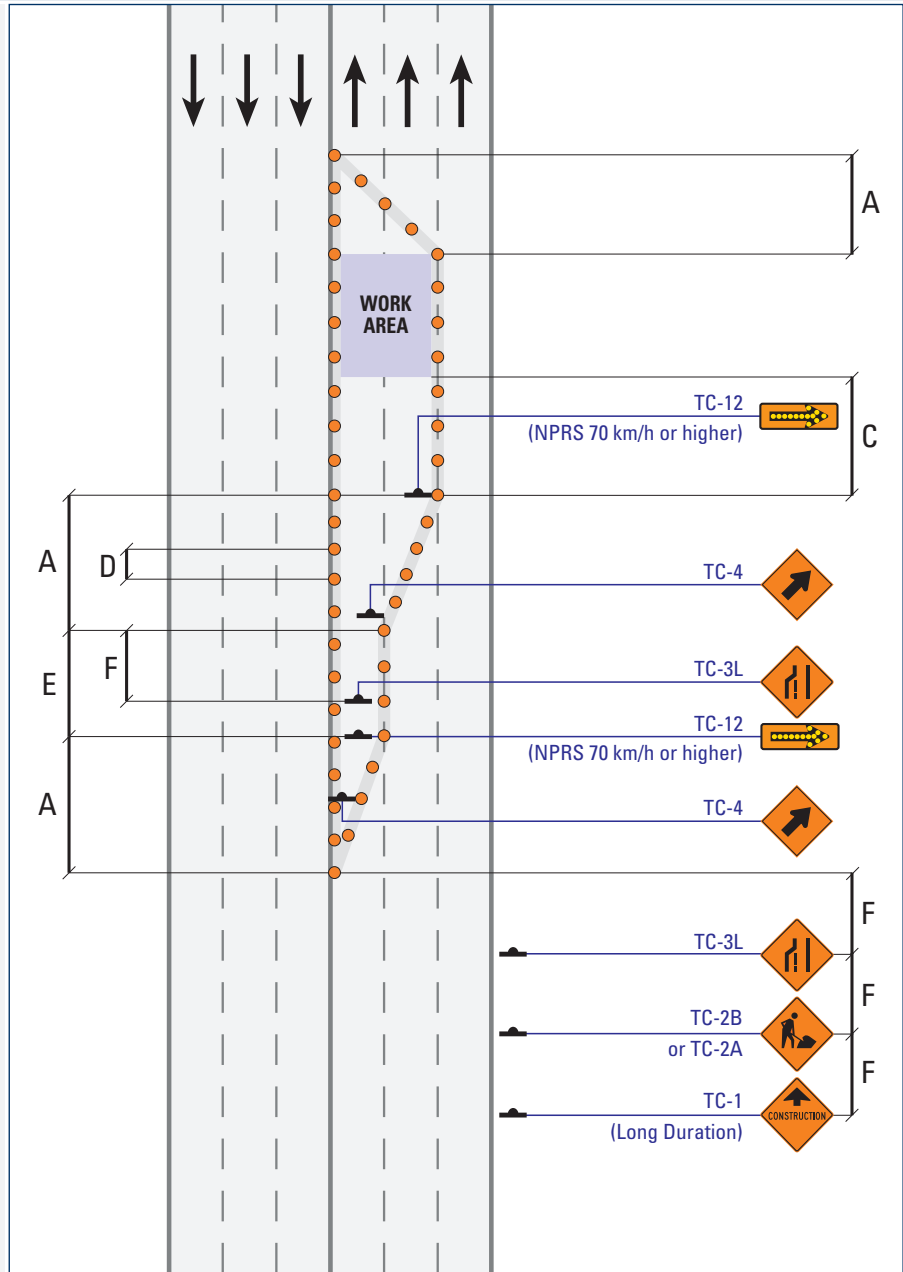

Normal Posted Regulatory Speed (km/h)

Label	Description	50	60	70	80	90
<b>A</b>	Taper Length for Full Lane Closure (m)	60	85	155	180	200
<b>C</b>	Longitudinal Buffer Area (LBA) (m)	(30)	(40)	50	60	75
<b>D</b>	Maximum Distance between Markers (m)	6	9	9	12	12
	Minimum Number of Markers for Taper	5	7	9	11	13
<b>E</b>	Minimum Tangent between Tapers (m)	60	85	155	180	200
<b>F</b>	Distance between Construction Signs (m)	50	90	120	140	150

**US-25**      **Route Detour (Alternative Roads)**

**Multi-Lane Undivided**    Mobile Operations    Intermittent    Very Short Duration    **Short Duration**    Long Duration

**NOTES**

- i) See US-26 for Sign Details.
- ii) The same approach to signing is required in the opposite direction.
- iii) TC-54 can be used in place of TC-53A.
- iv) If space is insufficient to install a TC-67, it may be replaced with a TC-65.

For further detail on Work Zone components, see [Table B \(Short/Long, pg. 241\)](#).

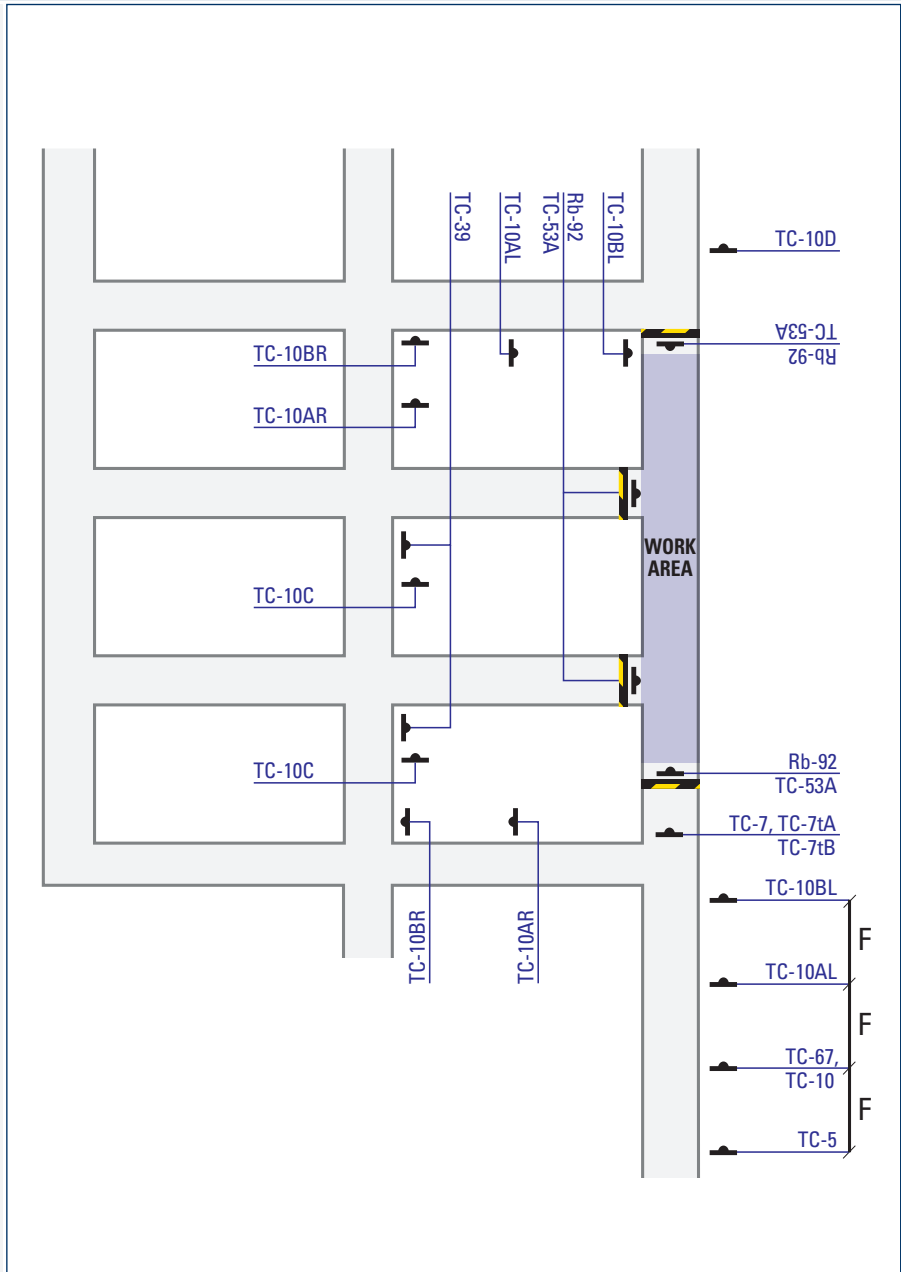

Label	Description	Normal Posted Regulatory Speed (km/h)				
		50	60	70	80	90
<b>F</b>	Distance between Construction Signs (m)	50	90	120	140	150

**US-26**

**Detour Signs and Devices**

**Multi-Lane Undivided**

Mobile Operations

Intermittent

Very Short Duration

**Short Duration**

Long Duration

**NOTES**

For further detail on Work Zone components, see [Table B \(Short/Long, pg. 241\)](#).

The following signs are to be used in the layout for Route Detour – see US-25.



TC-10



TC-10AR

Other tabs may be used with the  sign as follows:



TC-10BR



TC-10C



TC-10ER



TC-10FR



TC-10AL



TC-10BL



TC-10D



TC-10EL



TC-10FL

Roundabout Fish-hook tabs:



TC-10BRr



TC-10ALr



TC-10Cr



TC-39



TC-5



Rb-92



TC-7



TC-7tA



TC-7tB



TC-53A



TC-67



TC-10

MULTI-LANE  
UNDIVIDED



**US-27**

**Pedestrian Accommodation: Vehicle Encroachment on Road/Sidewalk**

**Multi-Lane Undivided**

Mobile Operations

Intermittent

**Very Short Duration**

Short Duration

Long Duration

**NOTES**

i) ▲ Location of Pedestrian Controllers if required (e.g., use of Booms or Hoists). Pedestrian passage under Boom is acceptable when Boom is not in motion and when Hoisting is not underway. Where activities at a Work Area could endanger the public (e.g., trenches, excavation), Pedestrian Barricades must be used.

For further detail on Work Zone components, see [Table A \(Mobile/Intermittent/Very Short, pg. 240\)](#).

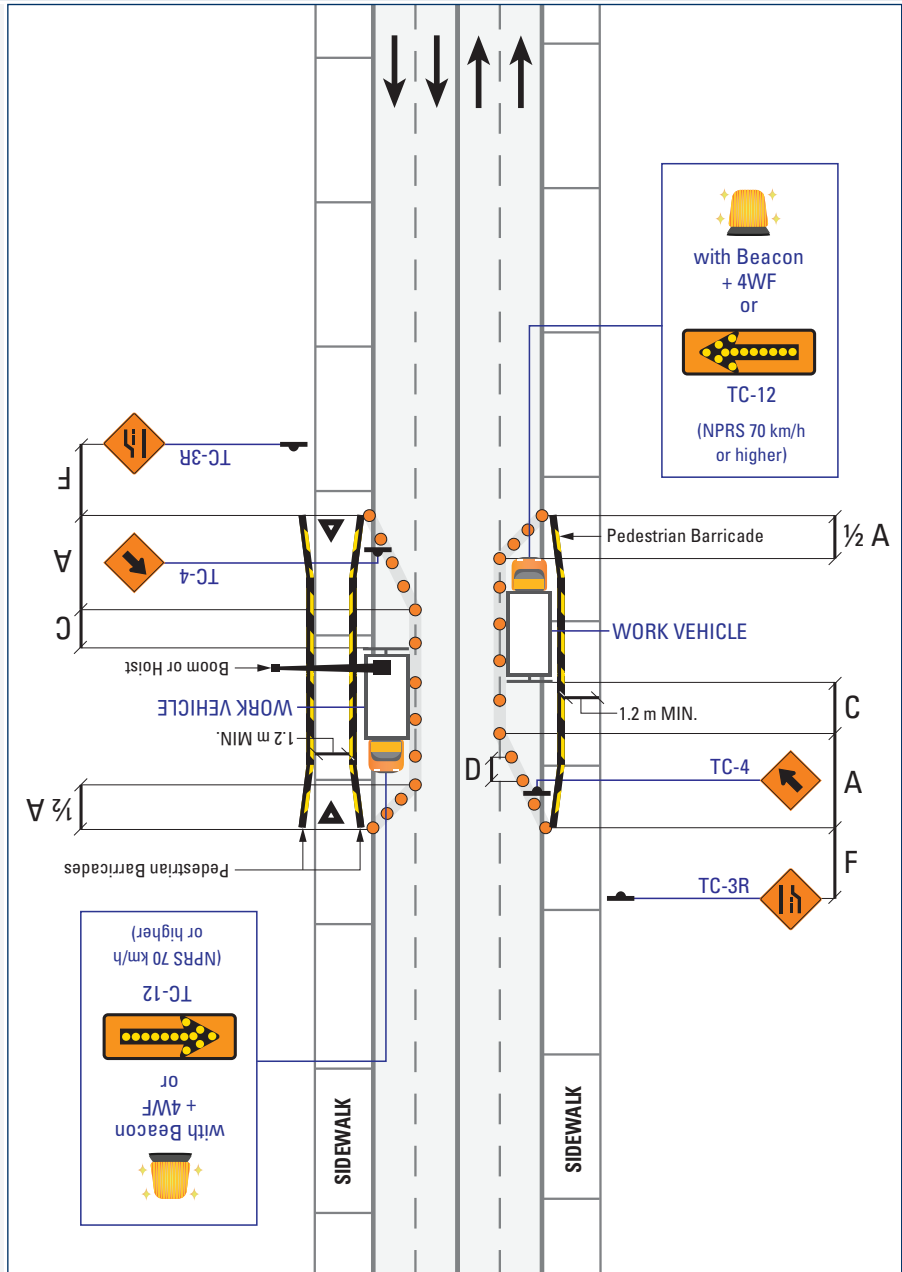

Label	Description	Normal Posted Regulatory Speed (km/h)				
		50	60	70	80	90
<b>A</b>	Taper Length for Full Lane Closure (m)	60	85	100	100	110
<b>C</b>	Longitudinal Buffer Area (LBA) (m)	(30)	(40)	50	60	75
<b>D</b>	Maximum Distance between Markers (m)	6	6	9	9	12
	Minimum Number of Markers for Taper	4	5	5	7	8
<b>F</b>	Distance between Construction Signs (m)	30	30	60	60	80

**US-28**

**Pedestrian Accommodation: Vehicle Encroachment on Road/Sidewalk**

**Multi-Lane Undivided**

Mobile Operations

Intermittent

Very Short Duration

**Short Duration**

Long Duration

**NOTES**

i) ▲ Location of Pedestrian Controllers if required (e.g., use of Booms or Hoists). Pedestrian passage under Boom is acceptable when Boom is not in motion and when Hoisting is not underway. Where activities at a Work Area could endanger the public (e.g., trenches, excavation), Pedestrian Barricades must be used.

For further detail on Work Zone components, see Table B (Short/Long, pg. 241).

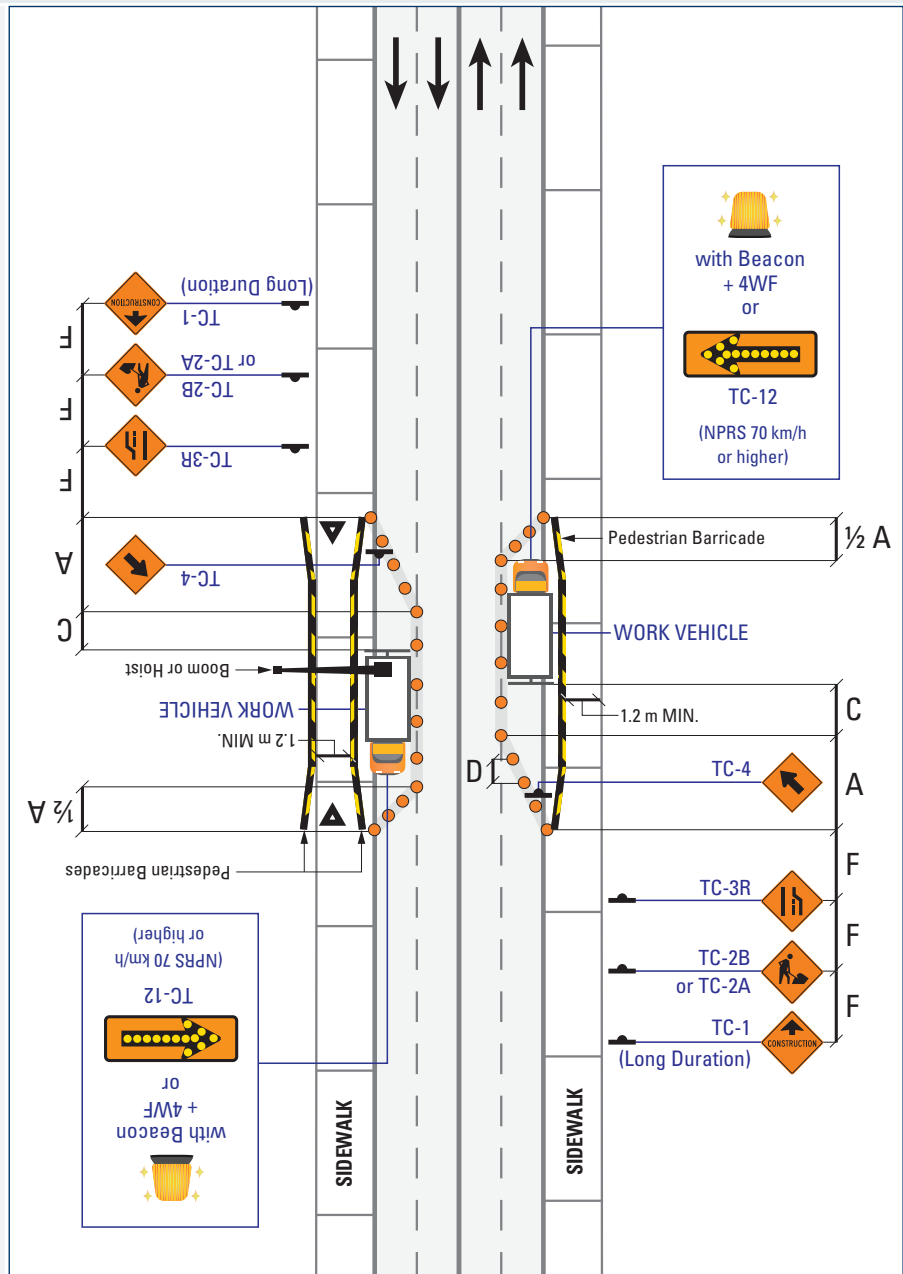

Normal Posted Regulatory Speed (km/h)

Label	Description	Normal Posted Regulatory Speed (km/h)				
		50	60	70	80	90
<b>A</b>	Taper Length for Full Lane Closure (m)	60	85	155	180	200
<b>C</b>	Longitudinal Buffer Area (LBA) (m)	(30)	(40)	50	60	75
<b>D</b>	Maximum Distance between Markers (m)	6	9	9	12	12
	Minimum Number of Markers for Taper	5	7	9	11	13
<b>F</b>	Distance between Construction Signs (m)	50	90	120	140	150

**US-29 Pedestrian Accommodation: Mid-Block Sidewalk Detour onto Roadway**

**Multi-Lane Undivided** Mobile Operations Intermittent Very Short Duration Short Duration Long Duration

**NOTES**

- i) For Sidewalk Closures of Long Durations, a boardwalk and railing should be provided instead of Pedestrian Barricades.
- ii) If close to a crosswalk, pedestrians can be directed to the opposite side of the street with a TC-40 and TC-40T installed at the crosswalk.
- iii) Minimum width of the temporary walkway is 1.2 m.
- iv) AODA-compliant ramps are required if the curb is raised.

For further detail on Work Zone components, see [Table B \(Short/Long, pg. 241\)](#).

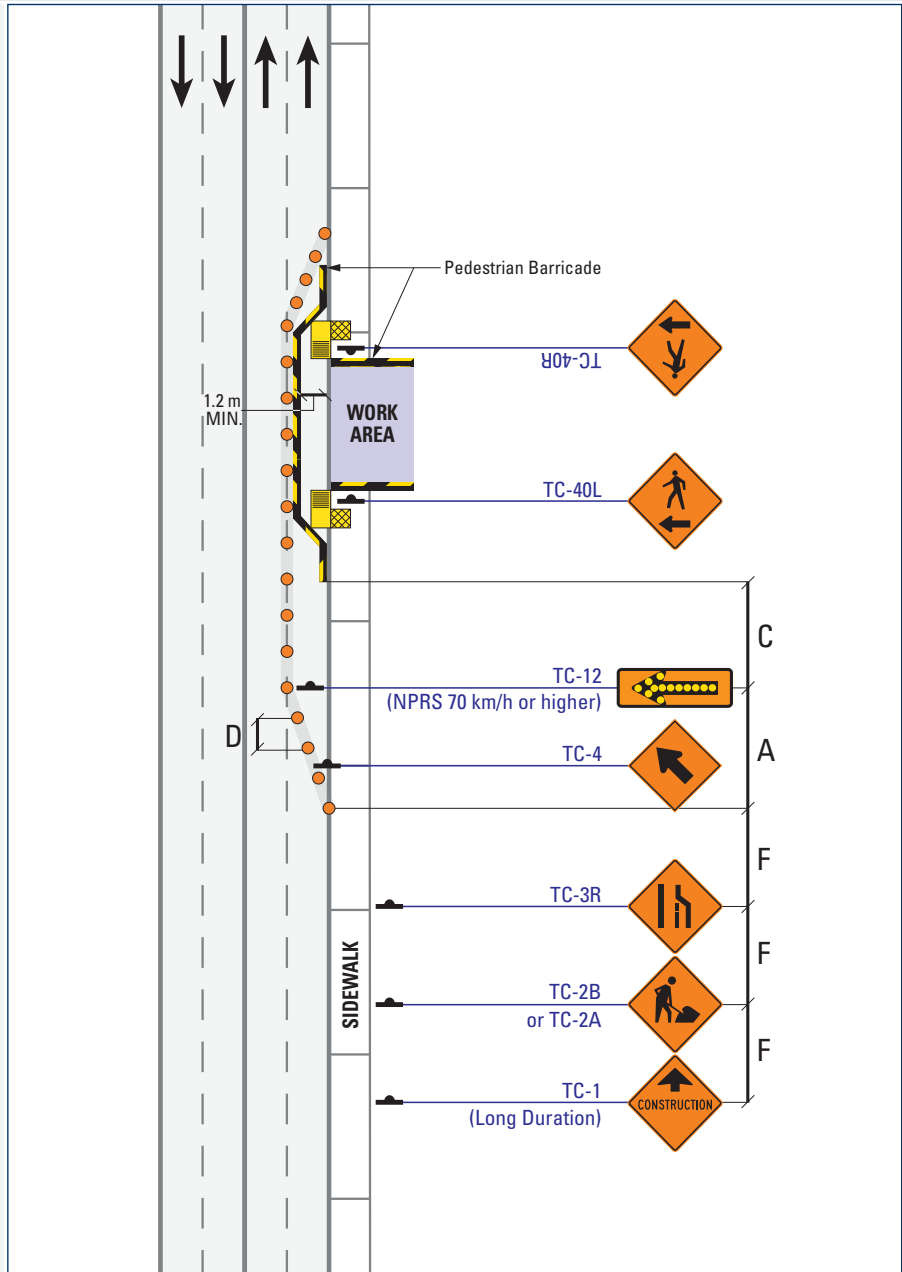

Label	Description	Normal Posted Regulatory Speed (km/h)				
		50	60	70	80	90
<b>A</b>	Taper Length for Full Lane Closure (m)	60	85	155	180	200
<b>C</b>	Longitudinal Buffer Area (LBA) (m)	(30)	(40)	50	60	75
<b>D</b>	Maximum Distance between Markers (m)	6	9	9	12	12
	Minimum Number of Markers for Taper	5	7	9	11	13
<b>F</b>	Distance between Construction Signs (m)	50	90	120	140	150

**US-30 Pedestrian Detour: Sidewalk Closure**

**Multi-Lane Undivided** Mobile Operations Intermittent Very Short Duration **Short Duration** Long Duration

**NOTES**

i) TC-40L/R Pedestrian Direction sign must be placed at the nearest upstream controlled pedestrian crossing (traffic signal of Pedestrian Crossover) in each direction.

For further detail on Work Zone components, see [Table B \(Short/Long, pg. 241\)](#).

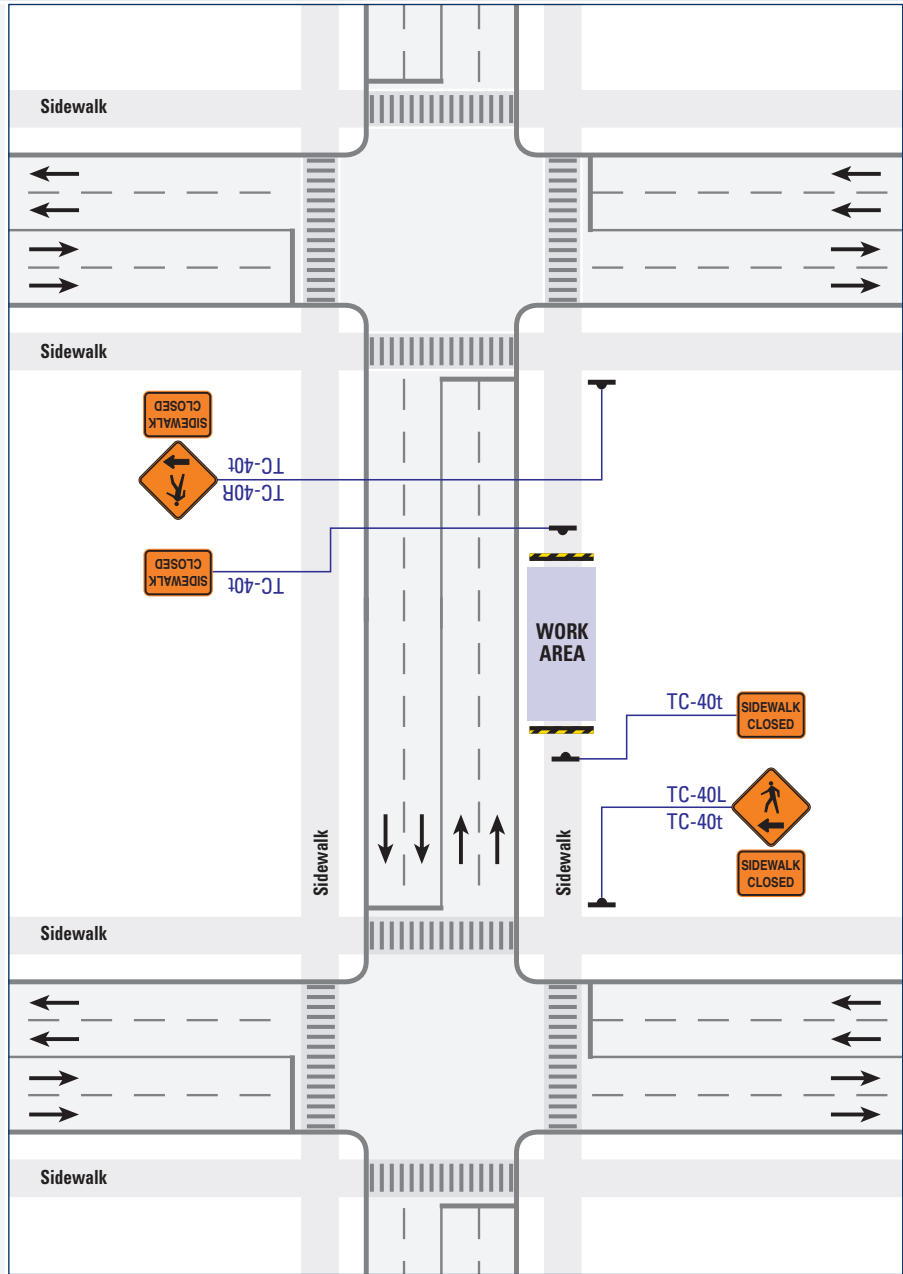

MULTI-LANE  
UNDIVIDED

**US-31 Bicycle Lane Diversion: Bicycle Lane Shift**

Multi-Lane Undivided    Mobile Operations    Intermittent    Very Short Duration    **Short Duration**    Long Duration

**NOTES**

- i) If space permits, TC-54 should be used in place of TC-51.
  - ii) AODA-compliant ramps are required if the curb is raised.
- For further detail on Work Zone components, see [Table B \(Short/Long, pg. 241\)](#).

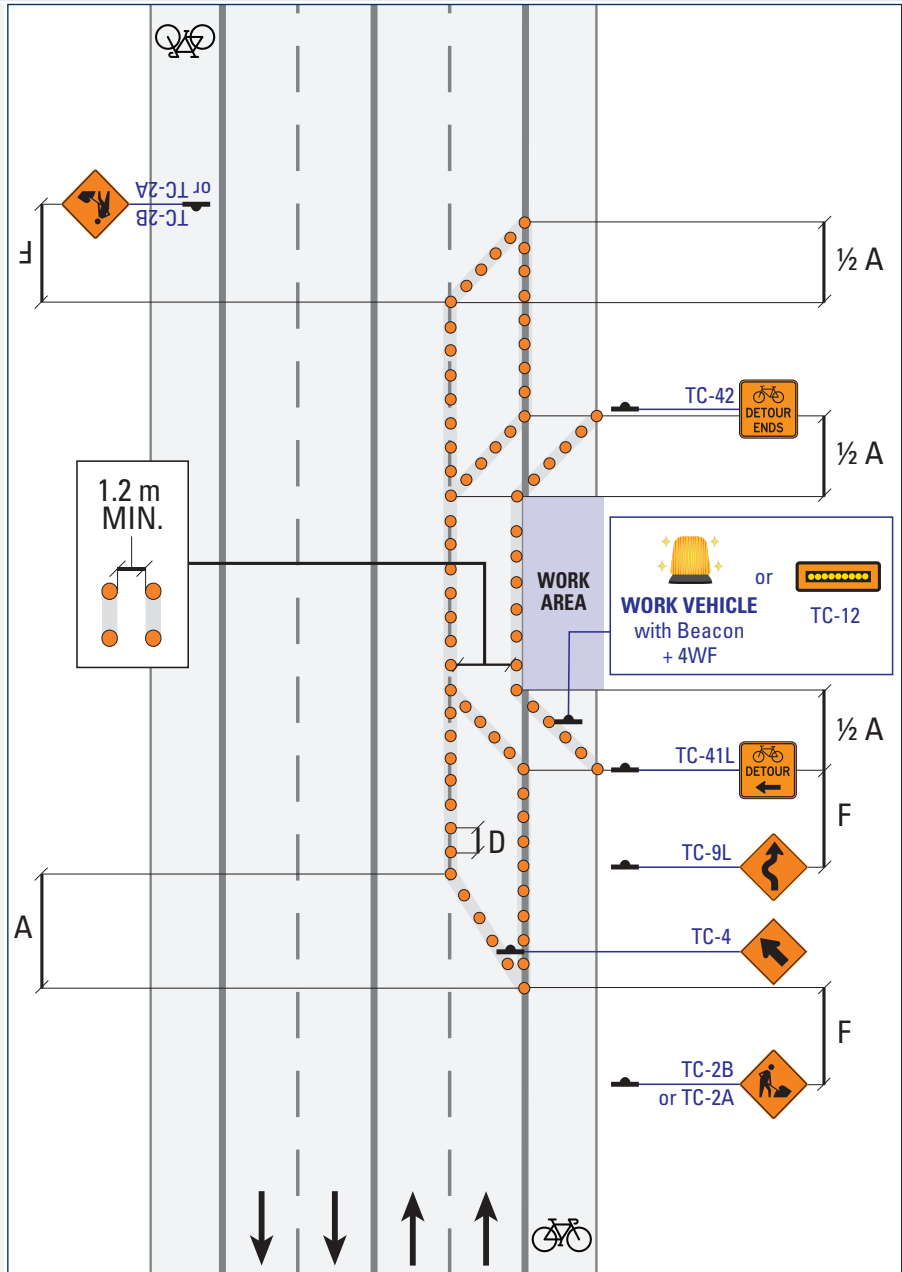

Label	Description	Normal Posted Regulatory Speed (km/h)				
		50	60	70	80	90
<b>A</b>	Taper Length for Full Lane Closure (m)	60	85	155	180	200
<b>D</b>	Maximum Distance between Markers (m)	6	9	9	12	12
	Minimum Number of Markers for Taper	5	7	9	11	13
<b>F</b>	Distance between Construction Signs (m)	50	90	120	140	150

**US-32 Bicycle Lane Diversion: Bicycle Lane Shift**

**Multi-Lane Undivided** Mobile Operations Intermittent Very Short Duration Short Duration Long Duration

**NOTES**

- i) If space permits, TC-54 should be used in place of TC-51.
  - ii) AODA-compliant ramps are required if the curb is raised.
- For further detail on Work Zone components, see [Table B \(Short/Long, pg. 241\)](#).

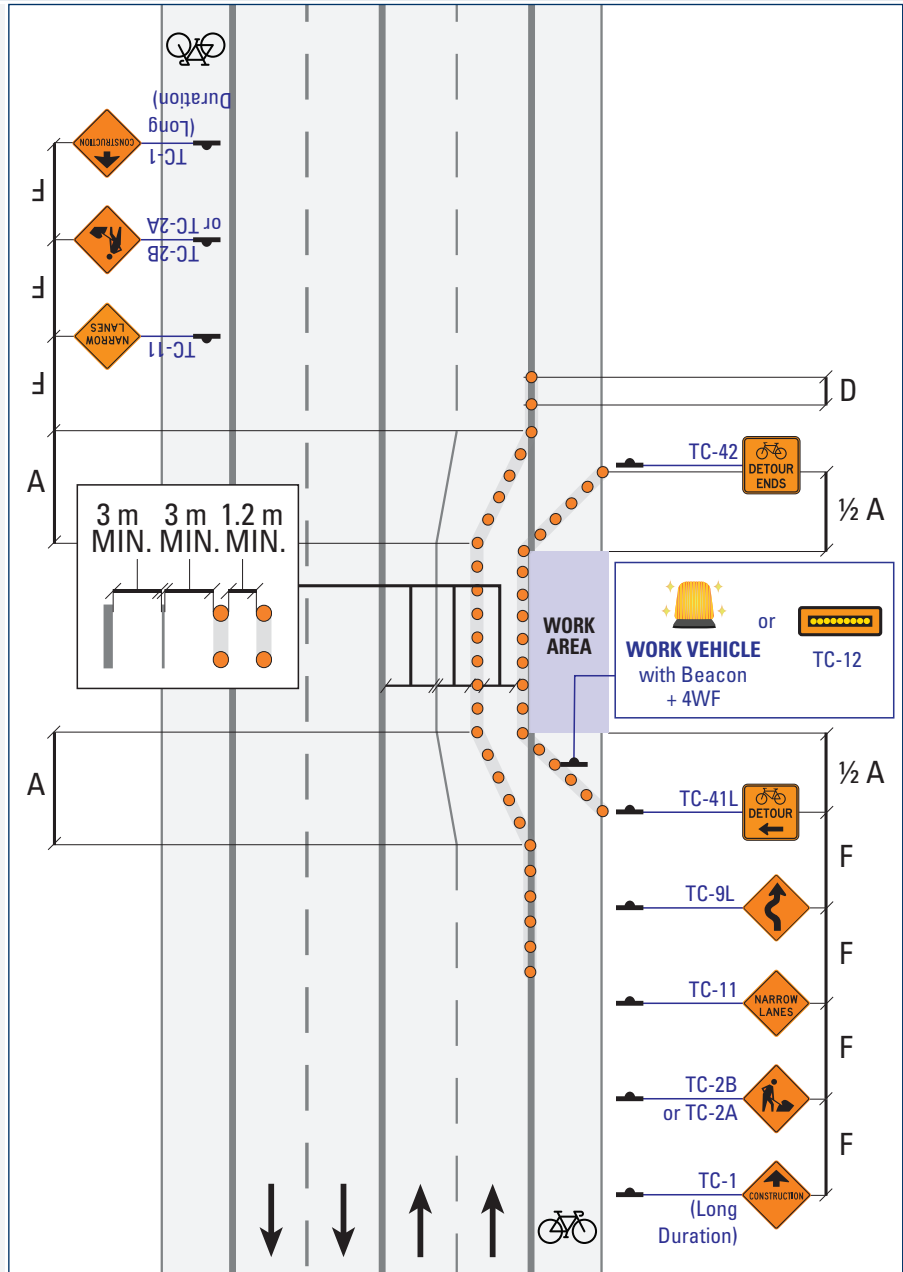

Normal Posted Regulatory Speed (km/h)

Label	Description	50	60	70	80	90
<b>A</b>	Taper Length for Full Lane Closure (m)	60	85	155	180	200
<b>D</b>	Maximum Distance between Markers (m)	6	9	9	12	12
	Minimum Number of Markers for Taper	5	7	9	11	13
<b>F</b>	Distance between Construction Signs (m)	50	90	120	140	150

**US-33**

**Bicycle Lane Diversion: Temporary Path**

**Multi-Lane Undivided**

Mobile Operations

Intermittent

Very Short Duration

**Short Duration**

Long Duration

**NOTES**

For further detail on Work Zone components, see [Table B \(Short/Long, pg. 241\)](#).

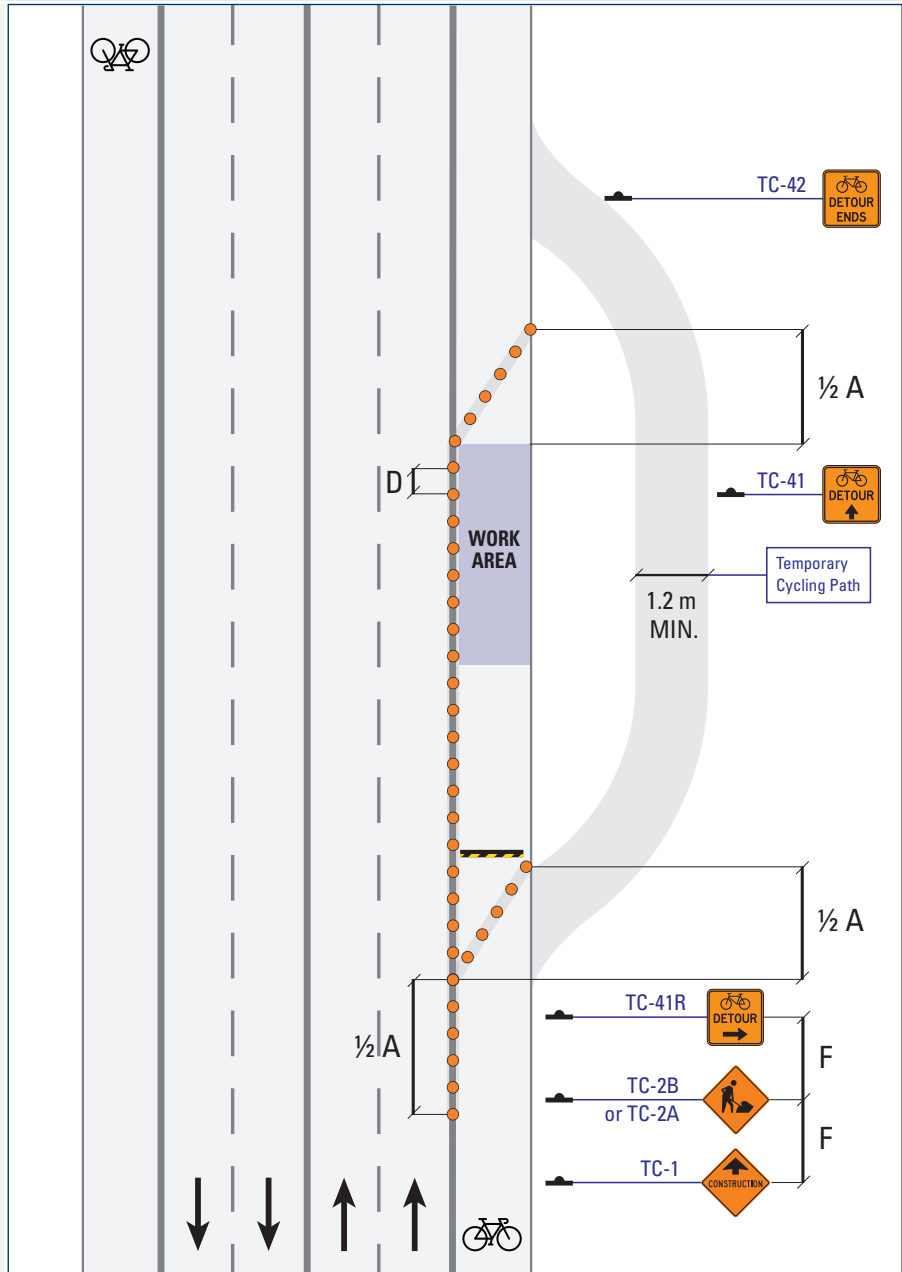

Label	Description	Normal Posted Regulatory Speed (km/h)				
		50	60	70	80	90
<b>A</b>	Taper Length for Full Lane Closure (m)	60	85	155	180	200
<b>D</b>	Maximum Distance between Markers (m)	6	9	9	12	12
	Minimum Number of Markers for Taper	5	7	9	11	13
<b>F</b>	Distance between Construction Signs (m)	50	90	120	140	150

**US-34 Bicycle Lane Diversion: Single File**

**Multi-Lane Undivided** Mobile Operations Intermittent Very Short Duration **Short Duration** Long Duration

**NOTES**

i) AODA-compliant ramps are required if the curb is raised.

ii) Ensure signage is visible for drivers to be aware of merging cyclists.

**Shared lane only to be used if considered by OTM Book 18 or MTO Bikeways Manual, Desirable Cycling Facility Nomograph. Otherwise, cycling Detour should be provided.**

For further detail on Work Zone components, see [Table B \(Short/Long, pg. 241\)](#).

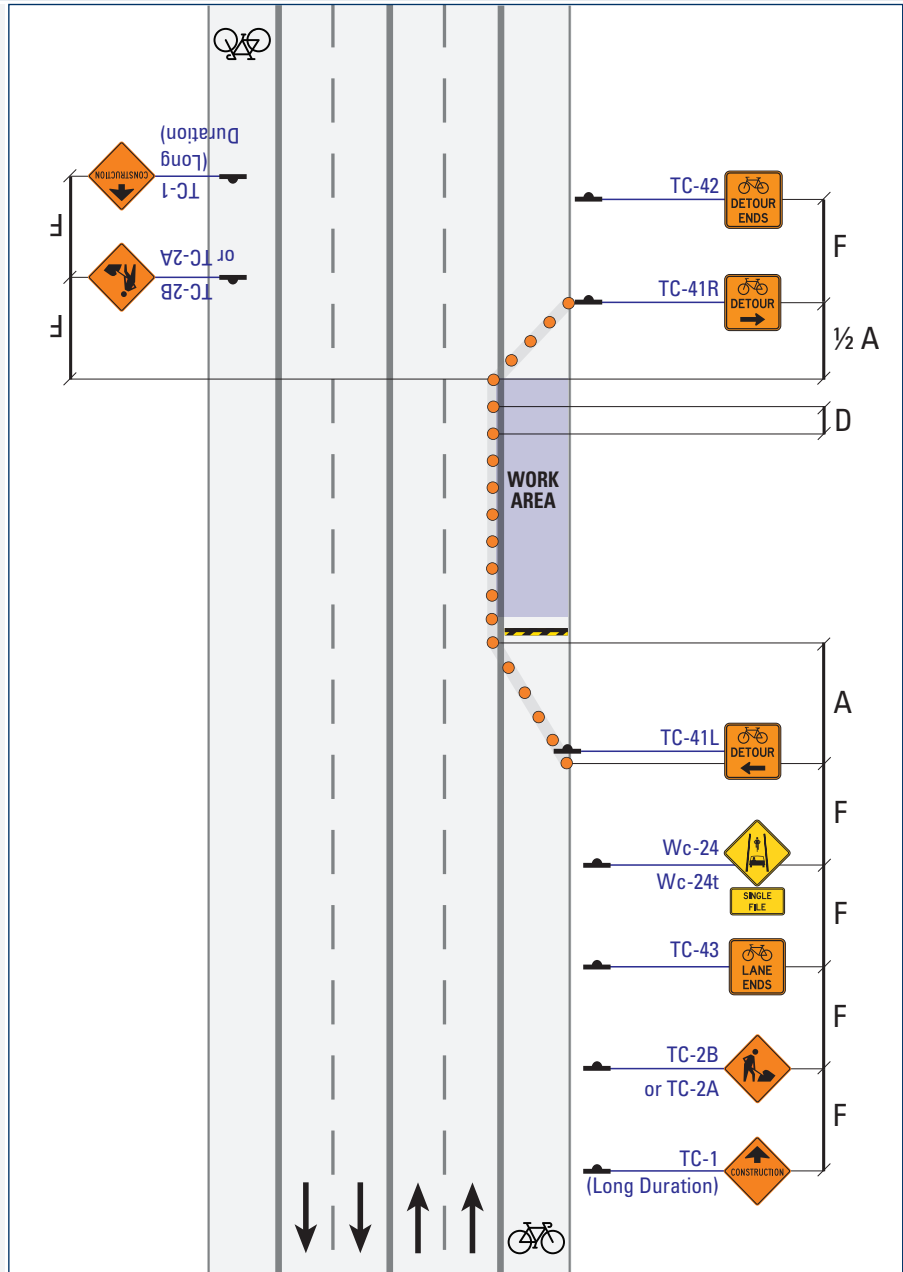

Normal Posted Regulatory Speed (km/h)

Label	Description	50	60	70	80	90
<b>A</b>	Taper Length for Full Lane Closure (m)	60	85	155	180	200
<b>D</b>	Maximum Distance between Markers (m)	6	9	9	12	12
	Minimum Number of Markers for Taper	5	7	9	11	13
<b>F</b>	Distance between Construction Signs (m)	50	90	120	140	150



**UI-1 Zone Painting: Intersection Turn Arrows**

**Multi-Lane Undivided** Mobile Operations Intermittent **Very Short Duration** Short Duration Long Duration

**NOTES**

- i) Centreline Delineation required if workers present.
- ii) It may be necessary to prohibit left turns.

For further detail on Work Zone components, see [Table A \(Mobile/Intermittent/Very Short, pg. 240\)](#).

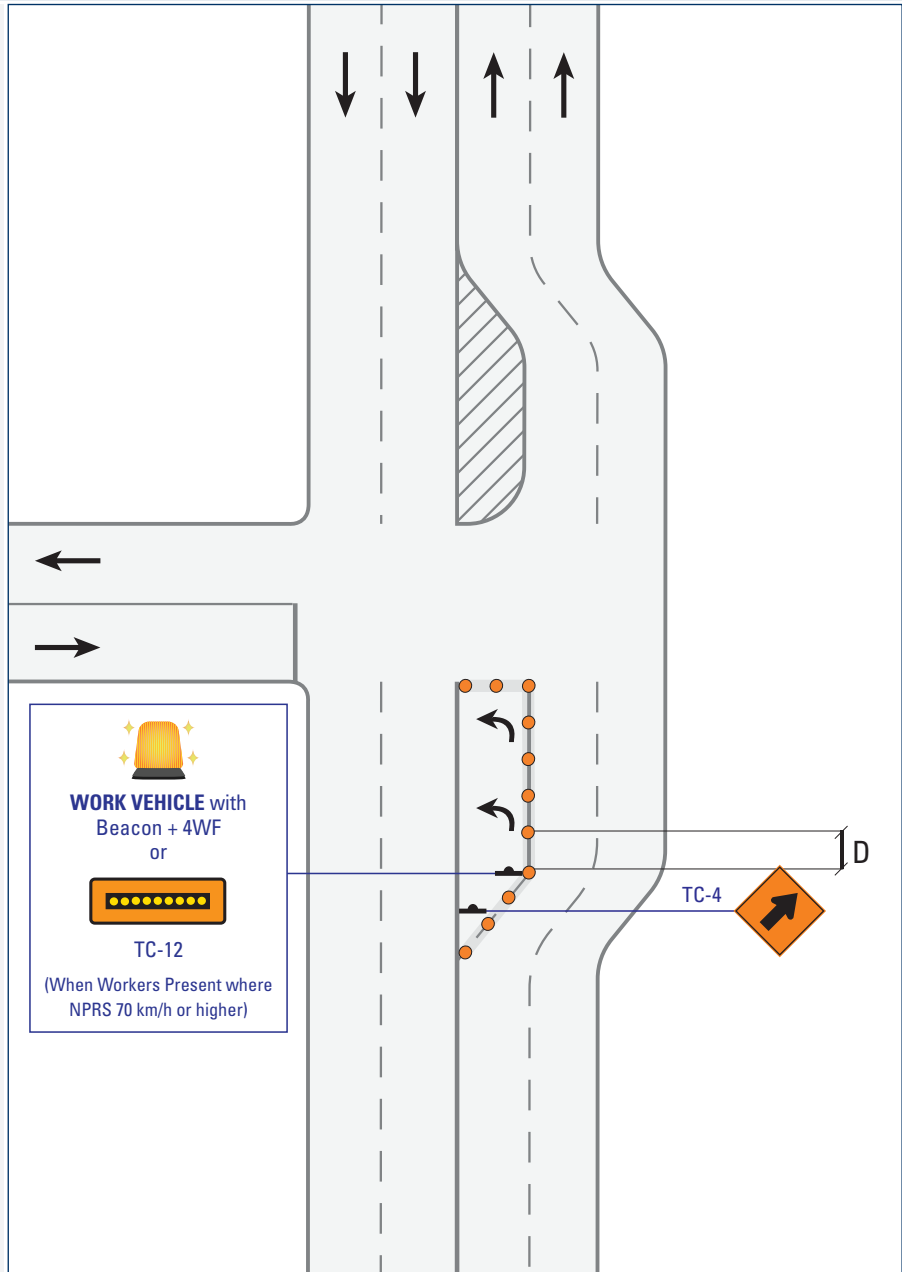

Label	Description	Normal Posted Regulatory Speed (km/h)				
		50	60	70	80	90
<b>D</b>	Maximum Distance between Markers (m)	6	6	9	9	12
	Minimum Number of Markers for Taper	4	5	5	7	8

**UI-2 Zone Painting: Intersection Turn Arrows**

**Multi-Lane Undivided** Mobile Operations Intermittent Very Short Duration **Short Duration** Long Duration

**NOTES**

- i) Centreline Delineation required if workers present.
- ii) It may be necessary to prohibit left turns.

For further detail on Work Zone components, see [Table B \(Short/Long, pg. 241\)](#).

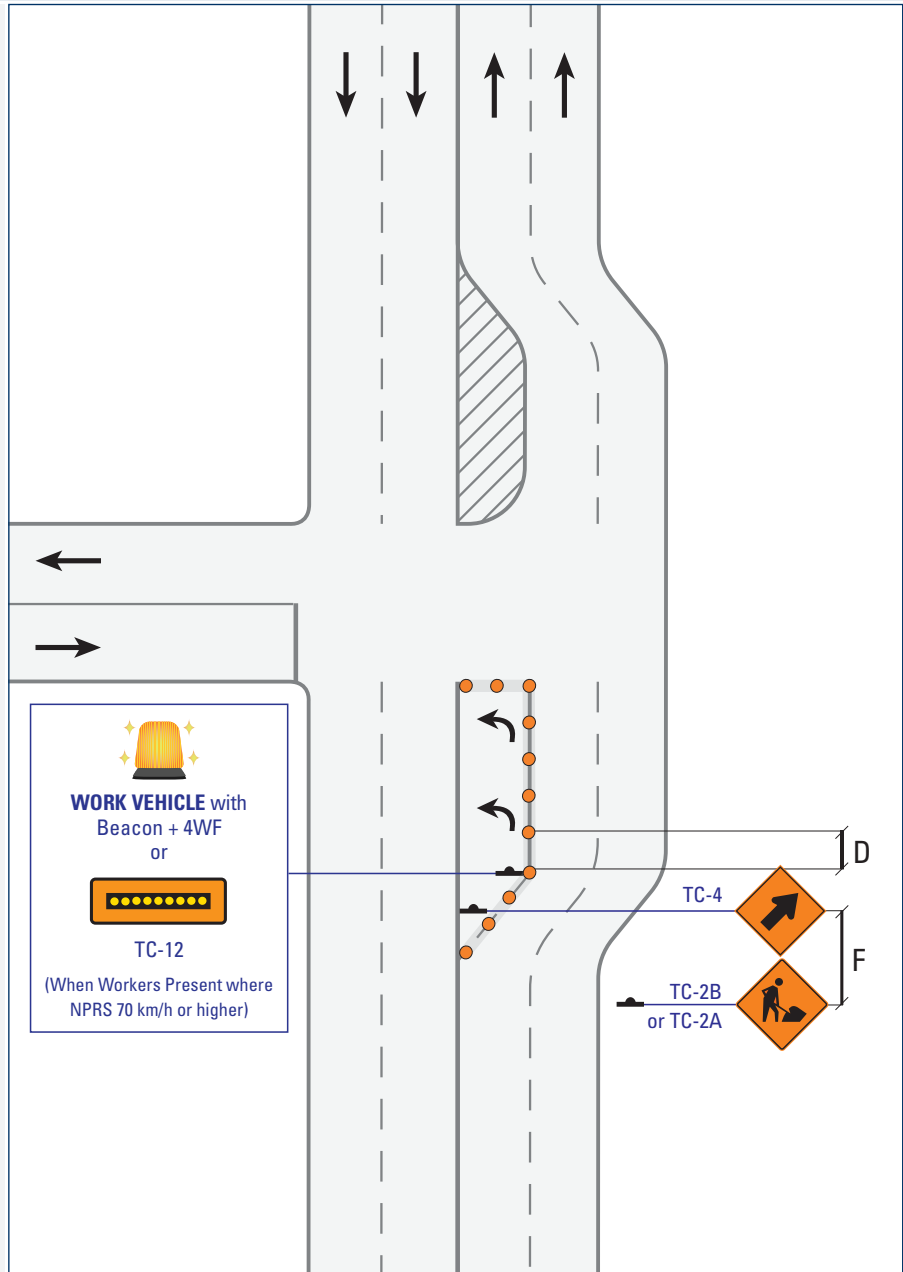

Label	Description	Normal Posted Regulatory Speed (km/h)				
		50	60	70	80	90
<b>D</b>	Maximum Distance between Markers (m)	6	9	9	12	12
	Minimum Number of Markers for Taper	5	7	9	11	13
<b>F</b>	Distance between Construction Signs (m)	50	90	120	140	150

**UI-3 Zone Painting: Intersection Left Lane Closed**

**Multi-Lane Undivided**

Mobile Operations

Intermittent

**Very Short Duration**

Short Duration

Long Duration

**NOTES**

For further detail on Work Zone components, see [Table A \(Mobile/Intermittent/Very Short, pg. 240\)](#).

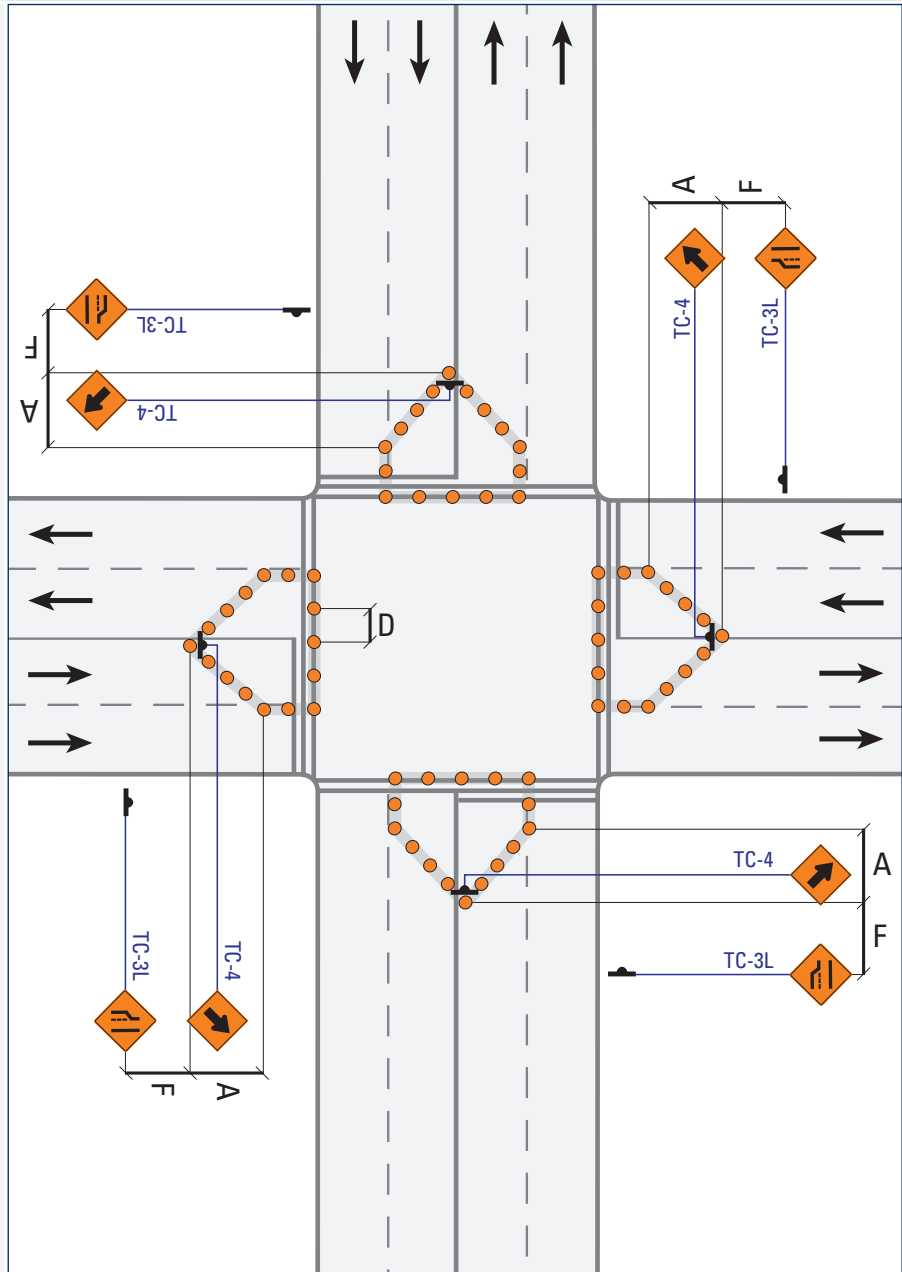

Label	Description	Normal Posted Regulatory Speed (km/h)				
		50	60	70	80	90
<b>A</b>	Taper Length for Full Lane Closure (m)	60	85	100	100	110
<b>D</b>	Maximum Distance between Markers (m)	6	6	9	9	12
	Minimum Number of Markers for Taper	4	5	5	7	8
<b>F</b>	Distance between Construction Signs (m)	30	30	60	60	80

**UI-4 Zone Painting: Intersection Left Lane Closed**

**Multi-Lane Undivided** Mobile Operations Intermittent Very Short Duration **Short Duration** Long Duration

**NOTES**

For further detail on Work Zone components, see [Table B \(Short/Long, pg. 241\)](#).

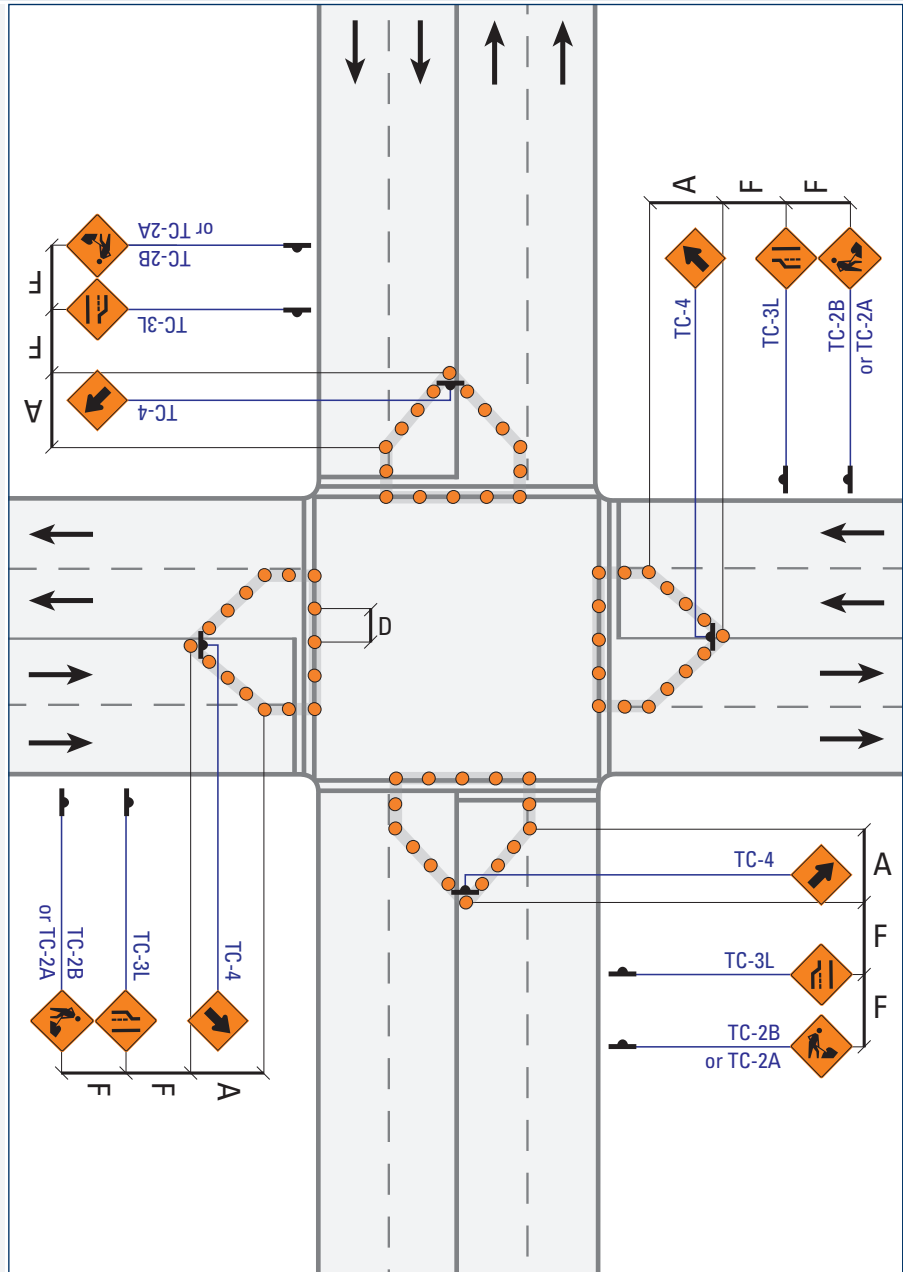

Normal Posted Regulatory Speed (km/h)

Label	Description	50	60	70	80	90
<b>A</b>	Taper Length for Full Lane Closure (m)	60	85	155	180	200
<b>D</b>	Maximum Distance between Markers (m)	6	9	9	12	12
	Minimum Number of Markers for Taper	5	7	9	11	13
<b>F</b>	Distance between Construction Signs (m)	50	90	120	140	150

**UI-5 Zone Painting: Intersection Right Lane Closed**

**Multi-Lane Undivided** Mobile Operations Intermittent **Very Short Duration** Short Duration Long Duration

**NOTES**

For further detail on Work Zone components, see [Table A \(Mobile/ Intermittent/Very Short, pg. 240\)](#).

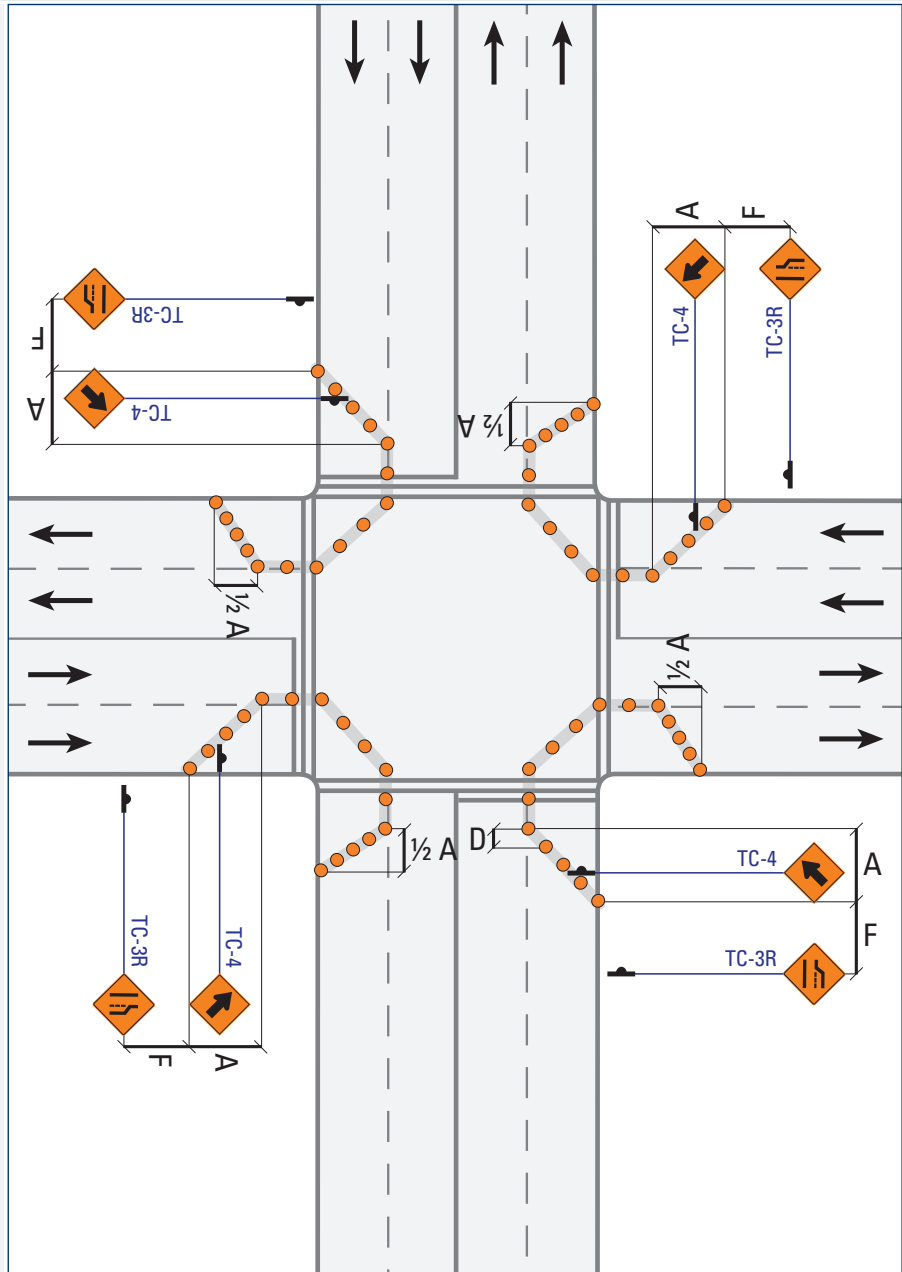

Normal Posted Regulatory Speed (km/h)

Label	Description	50	60	70	80	90
<b>A</b>	Taper Length for Full Lane Closure (m)	60	85	100	100	110
<b>D</b>	Maximum Distance between Markers (m)	6	6	9	9	12
	Minimum Number of Markers for Taper	4	5	5	7	8
<b>F</b>	Distance between Construction Signs (m)	30	30	60	60	80

**UI-6 Zone Painting: Intersection Right Lane Closed**

**Multi-Lane Undivided** Mobile Operations Intermittent Very Short Duration **Short Duration** Long Duration

**NOTES**

For further detail on Work Zone components, see [Table B \(Short/Long, pg. 241\)](#).

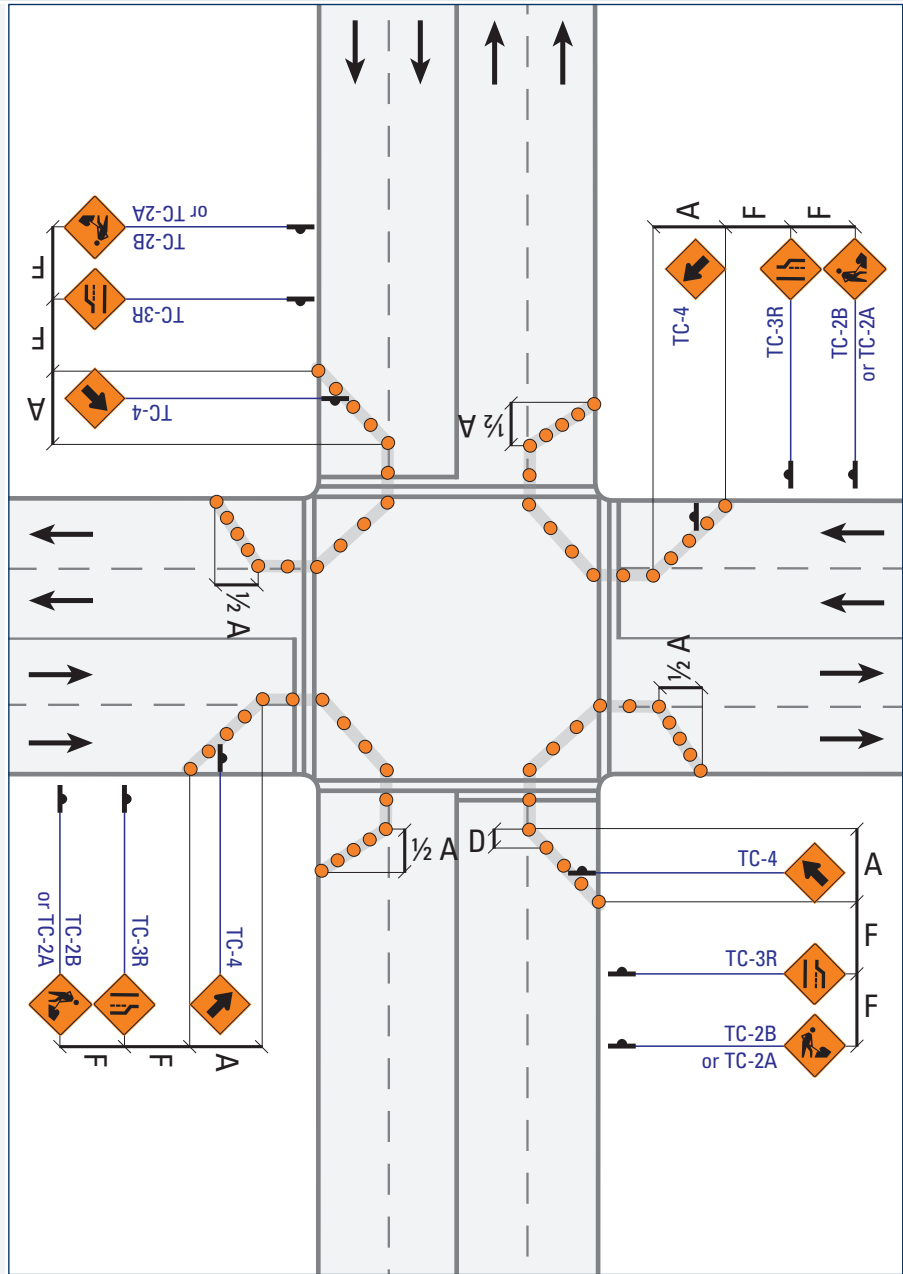

Normal Posted Regulatory Speed (km/h)

Label	Description	50	60	70	80	90
<b>A</b>	Taper Length for Full Lane Closure (m)	60	85	155	180	200
<b>D</b>	Maximum Distance between Markers (m)	6	9	9	12	12
	Minimum Number of Markers for Taper	5	7	9	11	13
<b>F</b>	Distance between Construction Signs (m)	50	90	120	140	150

**UI-7 Intersection: Near-Side Right or Left Through Lane Closed**

**Multi-Lane Undivided**

Mobile Operations

Intermittent

**Very Short Duration**

Short Duration

Long Duration

**NOTES**

i) Right Through Lane Closed: mirror image (for Markers, TC-12, TC-4).

For further detail on Work Zone components, see [Table A \(Mobile/Intermittent/Very Short, pg. 240\)](#).

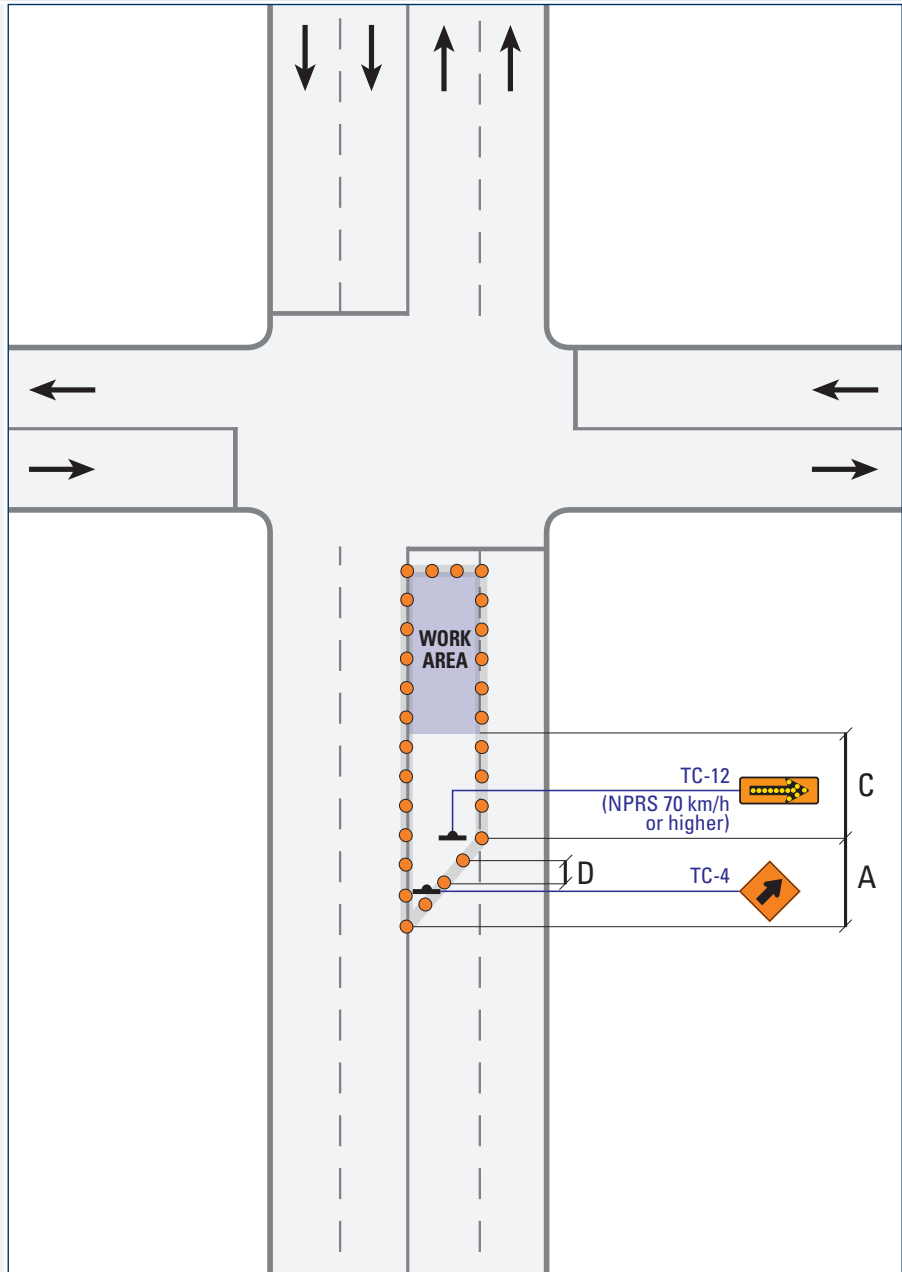

Label	Description	Normal Posted Regulatory Speed (km/h)				
		50	60	70	80	90
<b>A</b>	Taper Length for Full Lane Closure (m)	60	85	100	100	100
<b>C</b>	Longitudinal Buffer Area (LBA) (m)	(30)	(40)	50	60	75
<b>D</b>	Maximum Distance between Markers (m)	6	6	9	9	12
	Minimum Number of Markers for Taper	4	5	5	7	8

**UI-8**

**Intersection: Near-Side Right or Left Through Lane Closed**

**Multi-Lane Undivided**

Mobile Operations

Intermittent

Very Short Duration

Short Duration

Long Duration

**NOTES**

i) Right Through Lane Closed: mirror image (for Markers, TC-12, TC-4).

For further detail on Work Zone components, see [Table B \(Short/Long, pg. 241\)](#).

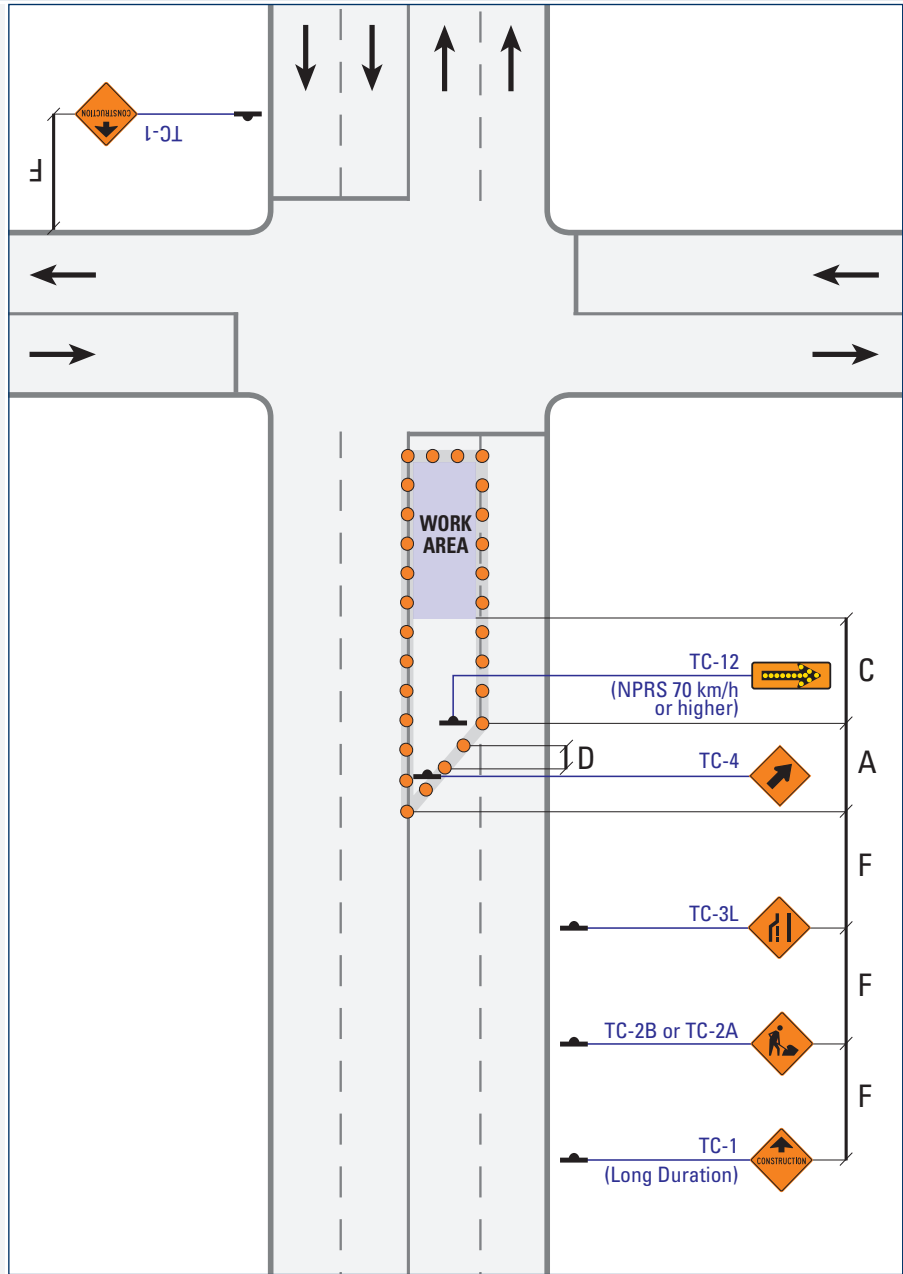

Normal Posted Regulatory Speed (km/h)

Label	Description	50	60	70	80	90
<b>A</b>	Taper Length for Full Lane Closure (m)	60	85	155	180	200
<b>C</b>	Longitudinal Buffer Area (LBA) (m)	(30)	(40)	50	60	75
<b>D</b>	Maximum Distance between Markers (m)	6	9	9	12	12
	Minimum Number of Markers for Taper	5	7	9	11	13
<b>F</b>	Distance between Construction Signs (m)	50	90	120	140	150



**UI-9 Intersection: Right Turn Lane Closed**

**Multi-Lane Undivided**

Mobile Operations

Intermittent

**Very Short Duration**

Short Duration

Long Duration

**NOTES**

For further detail on Work Zone components, see [Table A \(Mobile/Intermittent/Very Short, pg. 240\)](#).

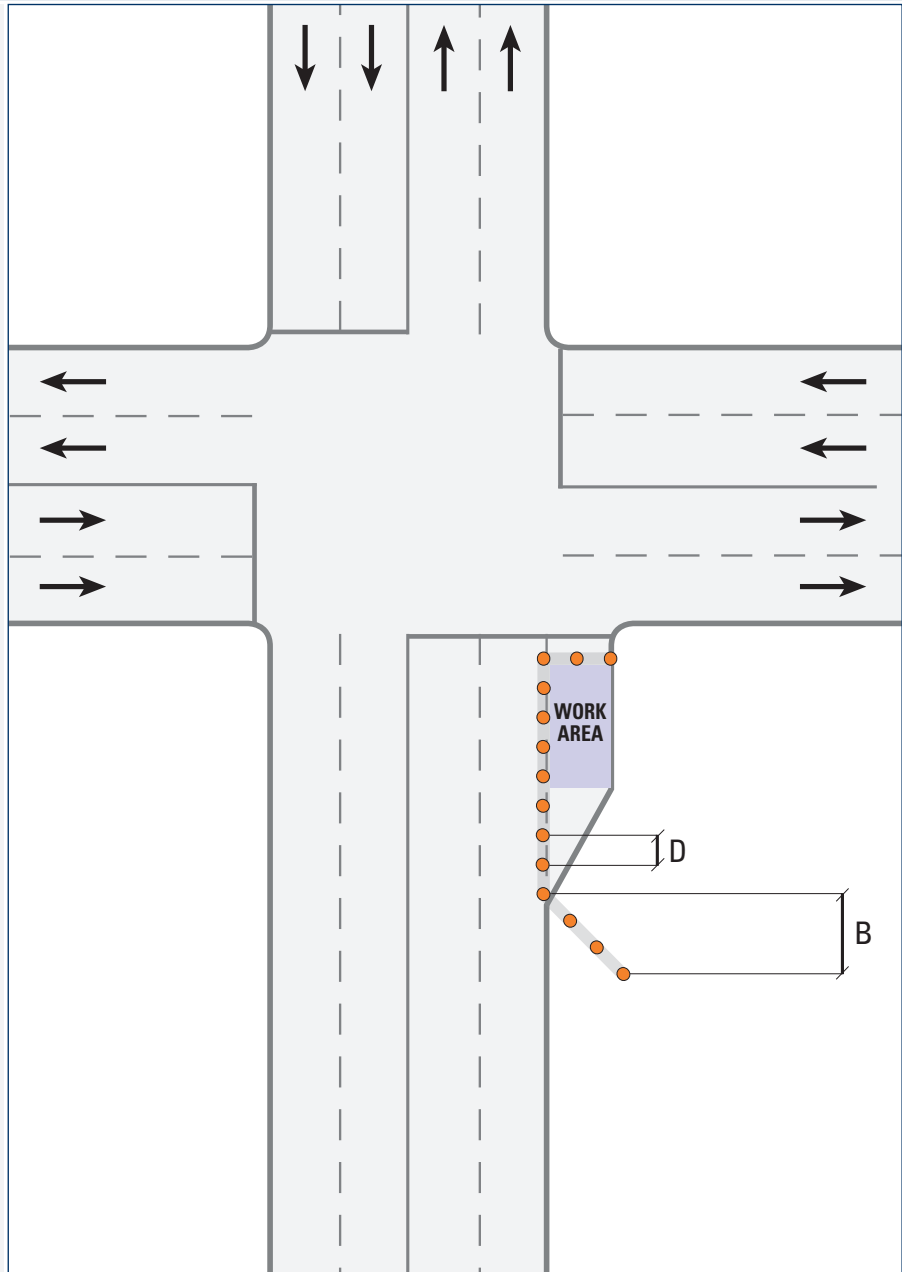

Label	Description	Normal Posted Regulatory Speed (km/h)				
		50	60	70	80	90
<b>B</b>	Shoulder Taper (m)	20	30	35	35	40
<b>D</b>	Maximum Distance between Markers (m)	6	6	9	9	12
	Minimum Number of Markers for Taper	4	5	5	7	8

**UI-10 Intersection: Right Turn Lane Closed**

**Multi-Lane Undivided** Mobile Operations Intermittent Very Short Duration **Short Duration** Long Duration

**NOTES**

For further detail on Work Zone components, see [Table B \(Short/Long, pg. 241\)](#).

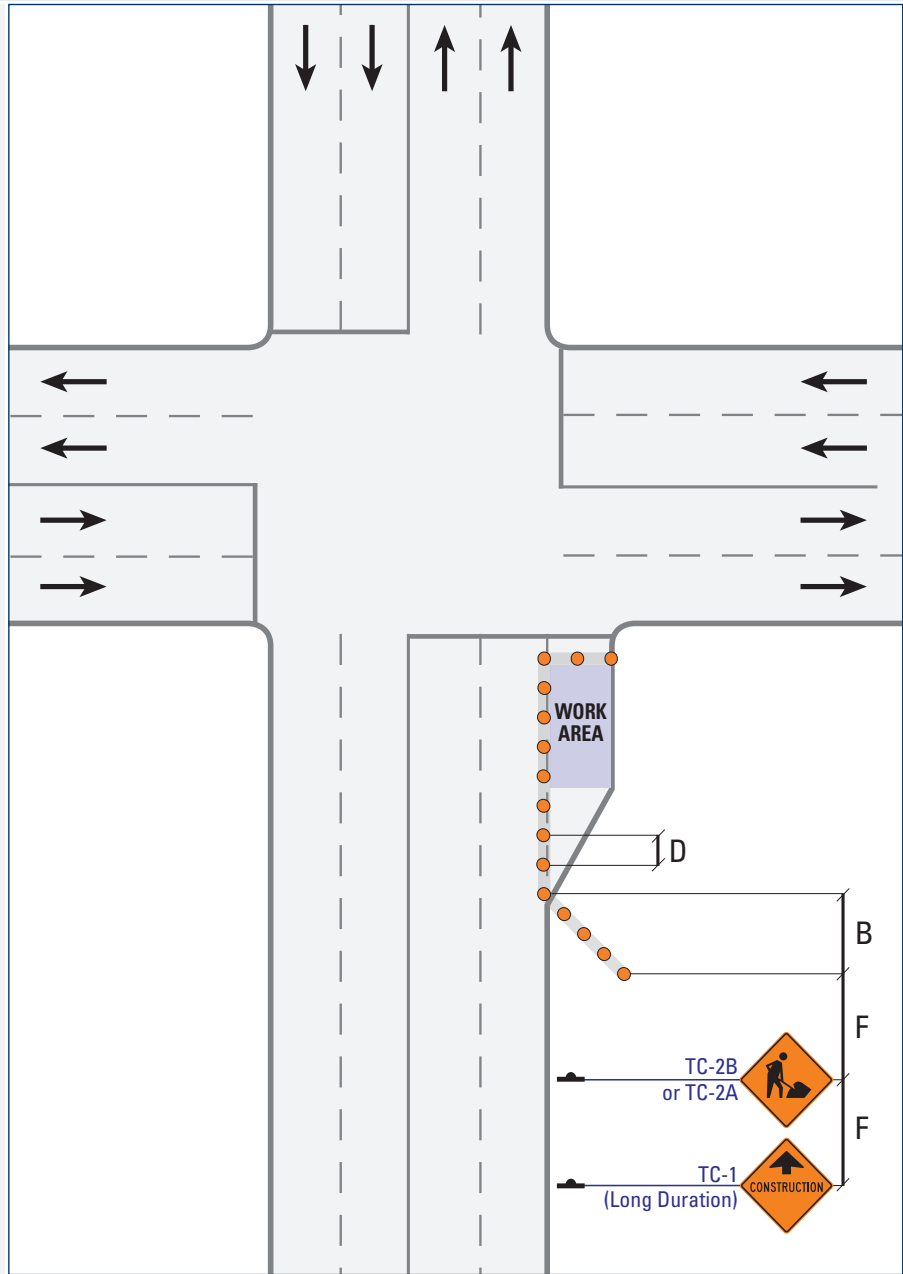

Normal Posted Regulatory Speed (km/h)

Label	Description	50	60	70	80	90
<b>B</b>	Shoulder Taper (m)	20	30	55	60	70
<b>D</b>	Maximum Distance between Markers (m)	6	9	9	12	12
	Minimum Number of Markers for Taper	5	7	9	11	13
<b>F</b>	Distance between Construction Signs (m)	50	90	120	140	150

**UI-11 Intersection: Left Turn Lane Closed**

**Multi-Lane Undivided**

Mobile Operations

Intermittent

**Very Short Duration**

Short Duration

Long Duration

**NOTES**

i) It may be necessary to prohibit left turns.

For further detail on Work Zone components, see [Table A \(Mobile/Intermittent/Very Short, pg. 240\)](#).

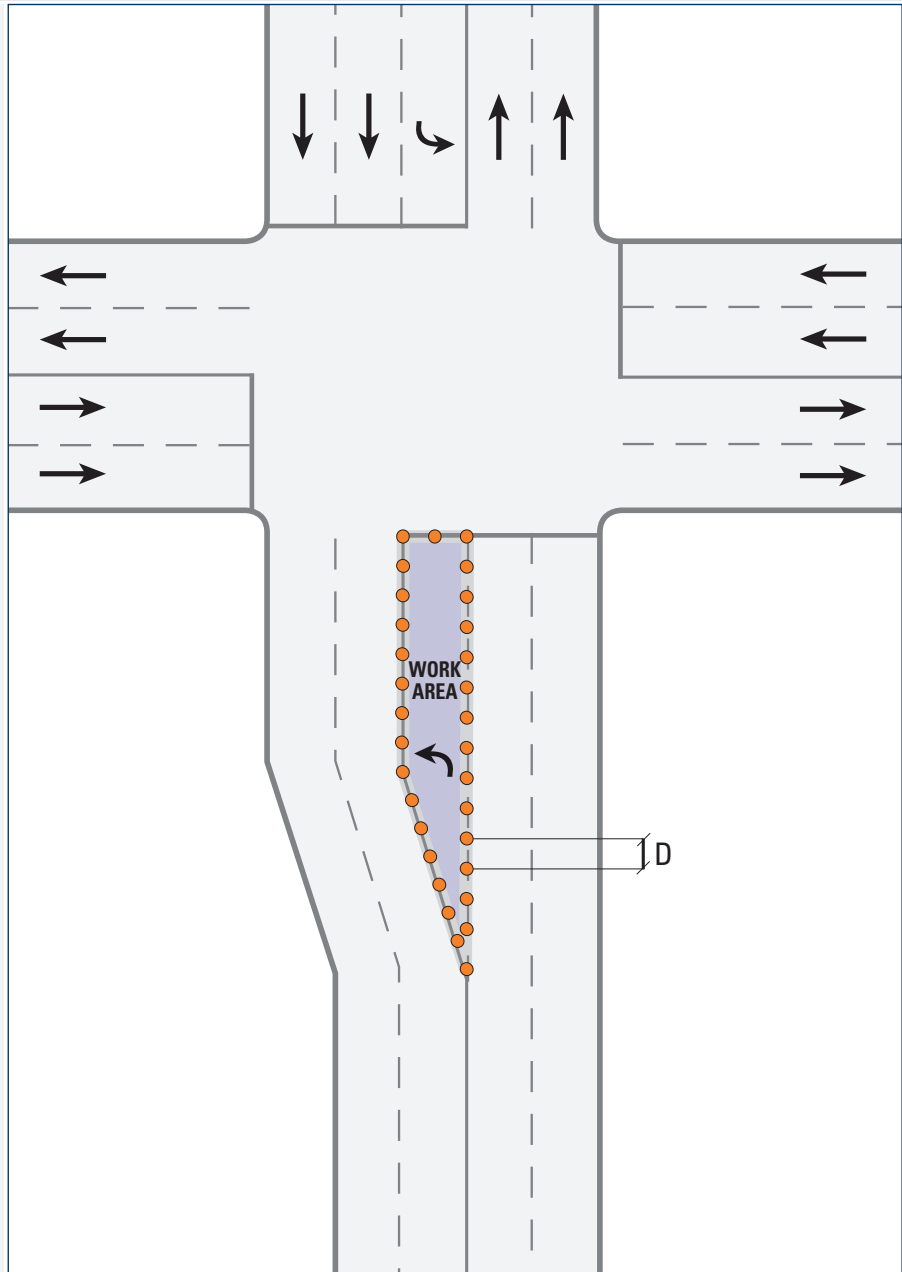

Label	Description	Normal Posted Regulatory Speed (km/h)				
		50	60	70	80	90
<b>D</b>	Maximum Distance between Markers (m)	6	6	9	9	12
	Minimum Number of Markers for Taper	4	5	5	7	8

**UI-12 Intersection: Left Turn Lane Closed**

**Multi-Lane Undivided** Mobile Operations Intermittent Very Short Duration Short Duration Long Duration

**NOTES**

i) It may be necessary to prohibit left turns.

For further detail on Work Zone components, see [Table B \(Short/Long, pg. 241\)](#).

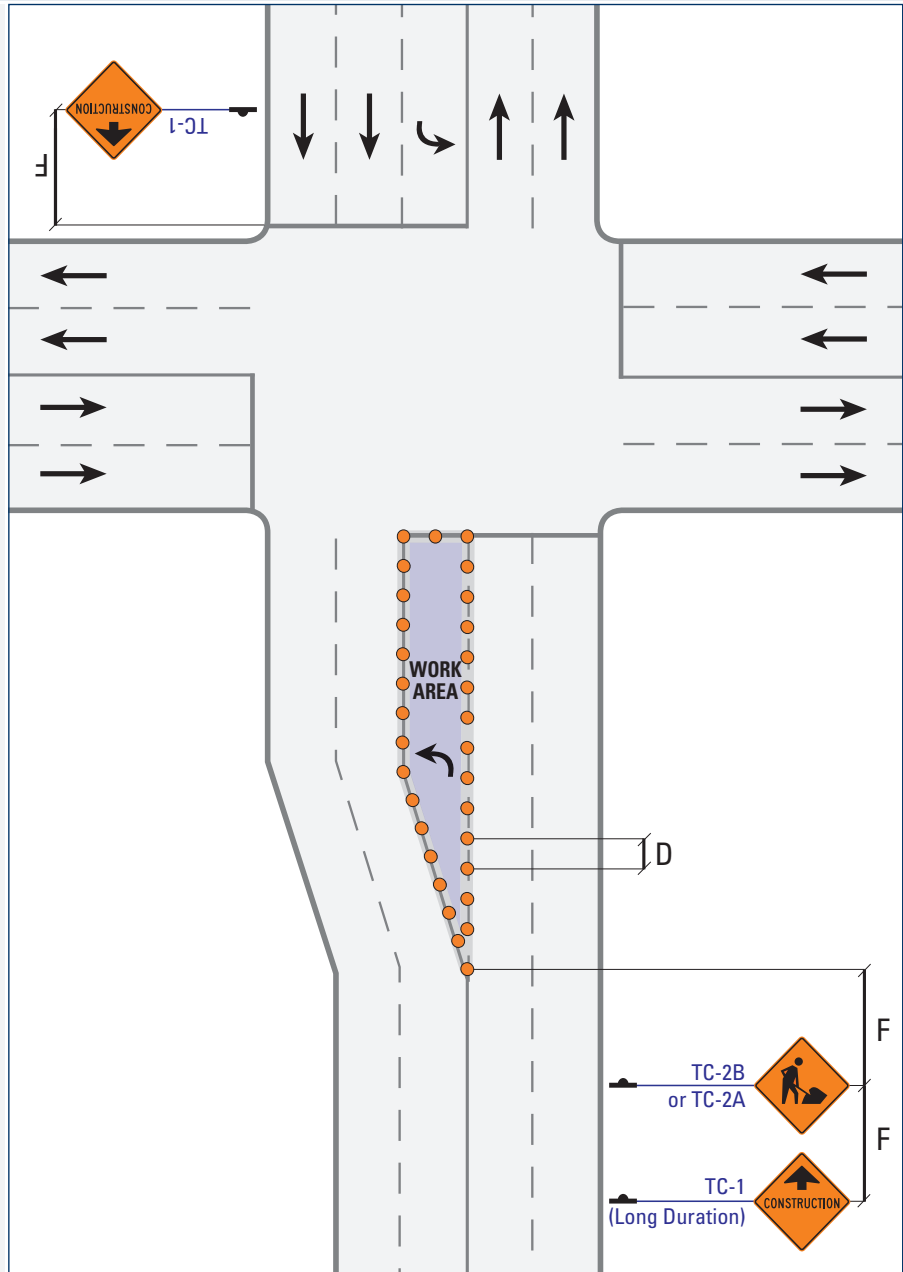

Normal Posted Regulatory Speed (km/h)

Label	Description	Normal Posted Regulatory Speed (km/h)				
		50	60	70	80	90
<b>D</b>	Maximum Distance between Markers (m)	6	9	9	12	12
	Minimum Number of Markers for Taper	5	7	9	11	13
<b>F</b>	Distance between Construction Signs (m)	50	90	120	140	150

**UI-13 Intersection: Far-Side Lane Closed**

**Multi-Lane Undivided**

Mobile Operations

Intermittent

**Very Short Duration**

Short Duration

Long Duration

**NOTES**

- i) Right Lane Closed: mirror image.
- ii) Measures should be taken to make sure on-street parking is not allowed next to the Work Area or Taper.
- iii) It may be necessary to prohibit left turns.

For further detail on Work Zone components, see [Table A \(Mobile/Intermittent/Very Short, pg. 240\)](#).

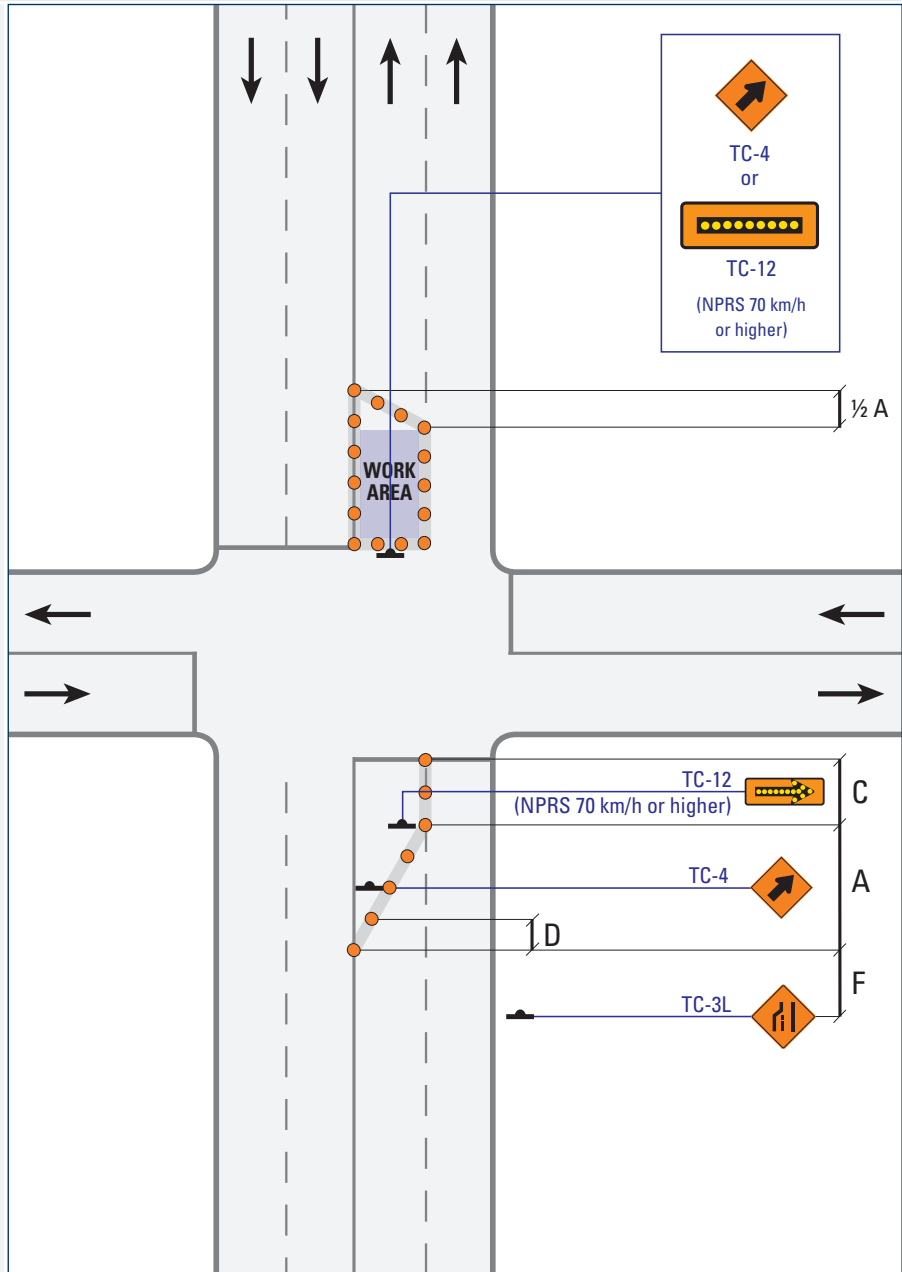

Label	Description	Normal Posted Regulatory Speed (km/h)				
		50	60	70	80	90
<b>A</b>	Taper Length for Full Lane Closure (m)	60	85	100	100	110
<b>C</b>	Longitudinal Buffer Area (LBA) (m)	(30)	(40)	50	60	75
<b>D</b>	Maximum Distance between Markers (m)	6	6	9	9	12
	Minimum Number of Markers for Taper	4	5	5	7	8
<b>F</b>	Distance between Construction Signs (m)	30	30	60	60	80

**UI-14 Intersection: Far-Side Lane Closed**

**Multi-Lane Undivided** Mobile Operations Intermittent Very Short Duration **Short Duration** Long Duration

**NOTES**

- i) Right Lane Closed: mirror image (Advance signs (TC-1 & TC-2) not required in opposing direction).
- ii) Measures should be taken to make sure on-street parking is not allowed next to the Work Area or Taper.
- iii) It may be necessary to prohibit left turns.

For further detail on Work Zone components, see [Table B \(Short/Long, pg. 241\)](#).

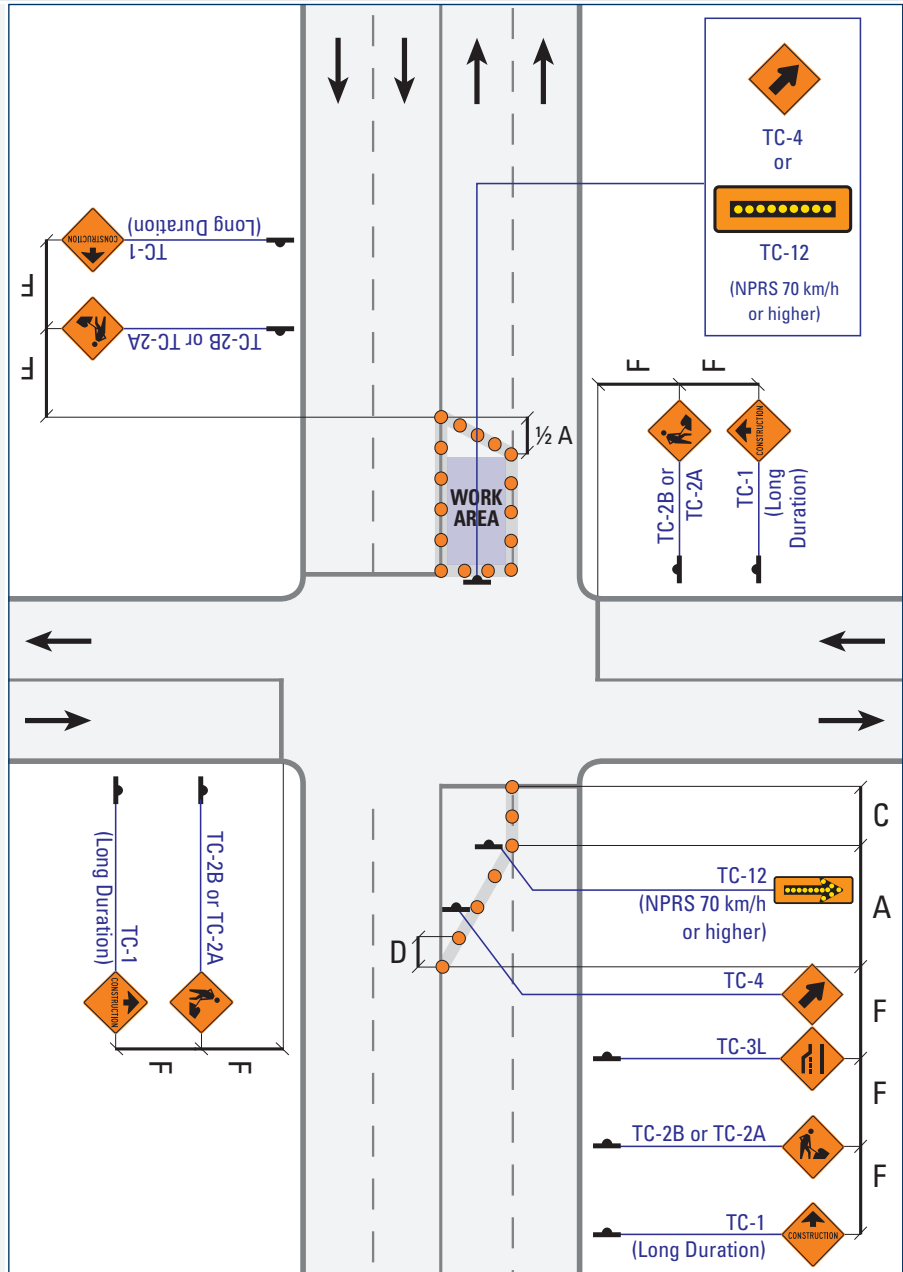

Normal Posted Regulatory Speed (km/h)

Label	Description	50	60	70	80	90
<b>A</b>	Taper Length for Full Lane Closure (m)	60	85	155	180	200
<b>C</b>	Longitudinal Buffer Area (LBA) (m)	(30)	(40)	50	60	75
<b>D</b>	Maximum Distance between Markers (m)	6	9	9	12	12
	Minimum Number of Markers for Taper	5	7	9	11	13
<b>F</b>	Distance between Construction Signs (m)	30	90	120	140	150

**UI-15 Intersection: Lane Adjacent to Right Turn Lane Closed**

**Multi-Lane Undivided** Mobile Operations Intermittent Very Short Duration **Short Duration** Long Duration

**NOTES**

i) If space permits, use TC-53A or TC-53B to surround the Work Area, otherwise reduce spacing between TC-54.

For further detail on Work Zone components, see [Table B \(Short/Long, pg. 241\)](#).

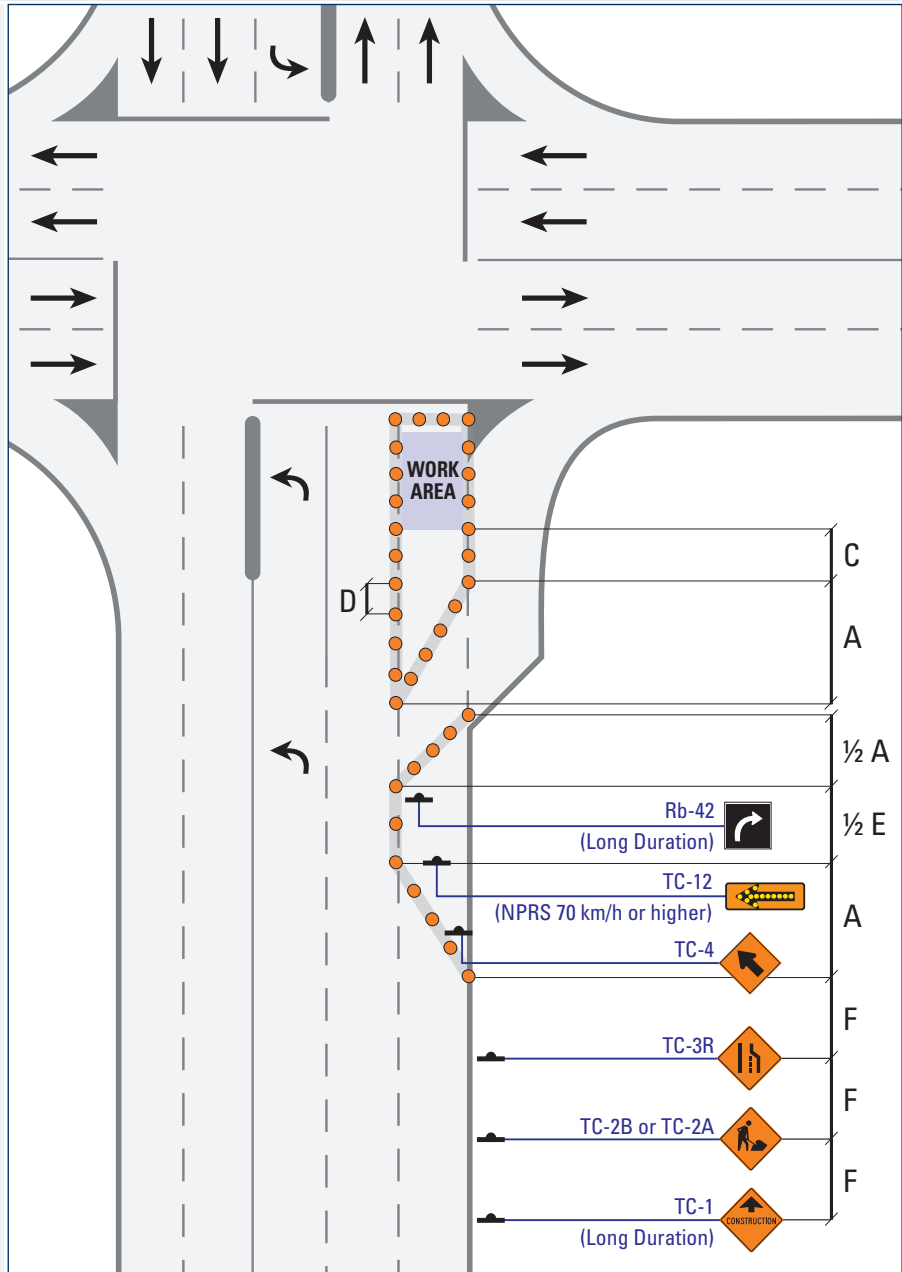

Normal Posted Regulatory Speed (km/h)

Label	Description	50	60	70	80	90
<b>A</b>	Taper Length for Full Lane Closure (m)	60	85	155	180	200
<b>C</b>	Longitudinal Buffer Area (LBA) (m)	(30)	(40)	50	60	75
<b>D</b>	Maximum Distance between Markers (m)	6	9	9	12	12
	Minimum Number of Markers for Taper	5	7	9	11	13
<b>E</b>	Minimum Tangent between Tapers (m)	60	85	155	180	200
<b>F</b>	Distance between Construction Signs (m)	50	90	120	140	150

**UI-16**

**Intersection: Lane Adjacent to Left Turn Lane Closed**

**Multi-Lane Undivided**

Mobile Operations

Intermittent

Very Short Duration

Short Duration

Long Duration

**NOTES**

i) If space permits, use TC-53A or TC-53B to surround the Work Area, otherwise reduce spacing between TC-54.

For further detail on Work Zone components, see [Table B \(Short/Long, pg. 241\)](#).

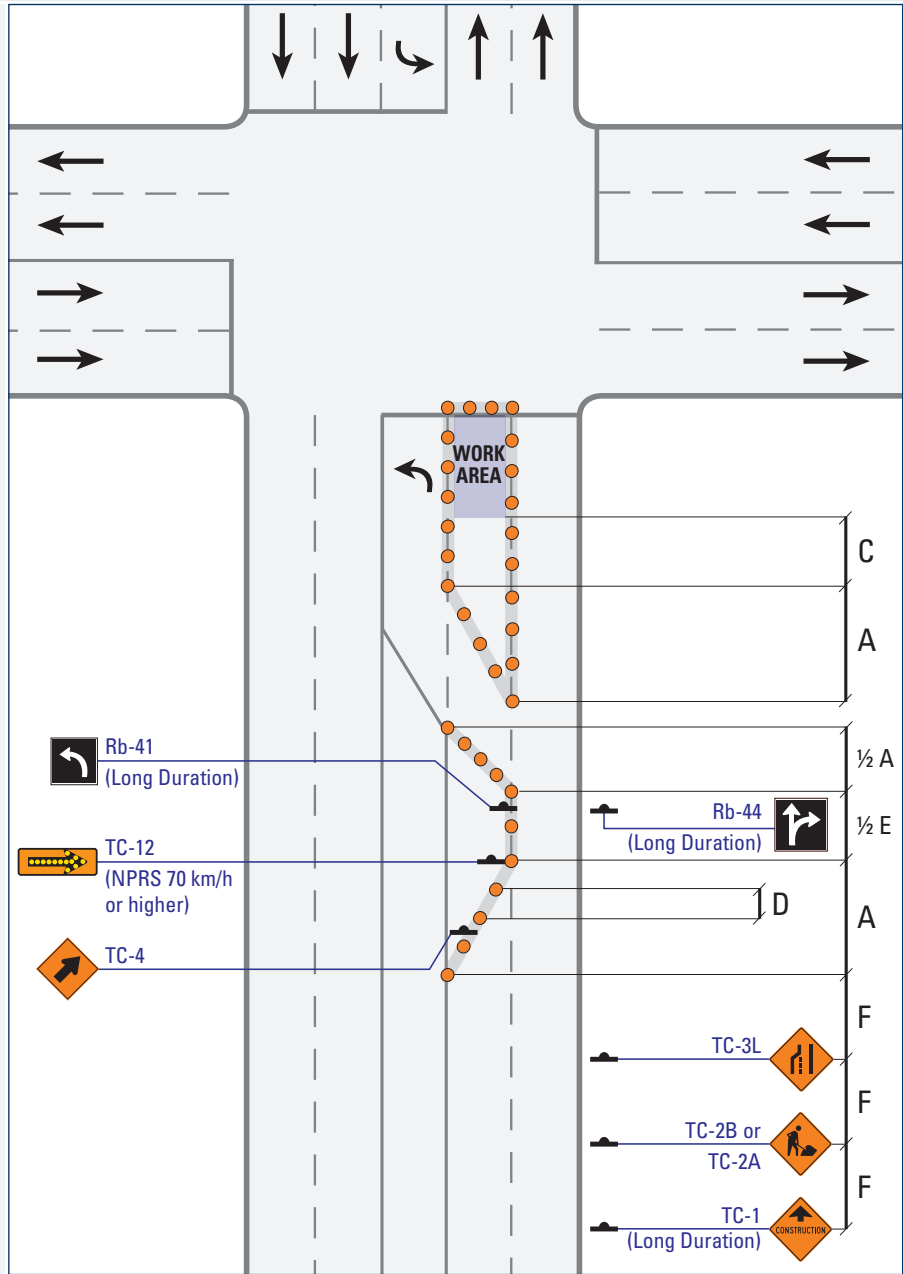

Normal Posted Regulatory Speed (km/h)

Label	Description	50	60	70	80	90
<b>A</b>	Taper Length for Full Lane Closure (m)	60	85	155	180	200
<b>C</b>	Longitudinal Buffer Area (LBA) (m)	(30)	(40)	50	60	75
<b>D</b>	Maximum Distance between Markers (m)	6	9	9	12	12
	Minimum Number of Markers for Taper	5	7	9	11	13
<b>E</b>	Minimum Tangent between Tapers (m)	60	85	155	180	200
<b>F</b>	Distance between Construction Signs (m)	50	90	120	140	150



UI-17

Intersection: Right Turn Lane (Far-Side Right Lane Closed)

Multi-Lane Undivided

Mobile Operations

Intermittent

Very Short Duration

Short Duration

Long Duration

NOTES

i) If space permits, use TC-53A or TC-53B to surround the Work Area, otherwise reduce spacing between TC-54.

ii) It may be necessary to prohibit certain turning movements.

iii) It may be necessary to prohibit right turn truck movements.

For further detail on Work Zone components, see [Table B \(Short/Long, pg. 241\)](#).

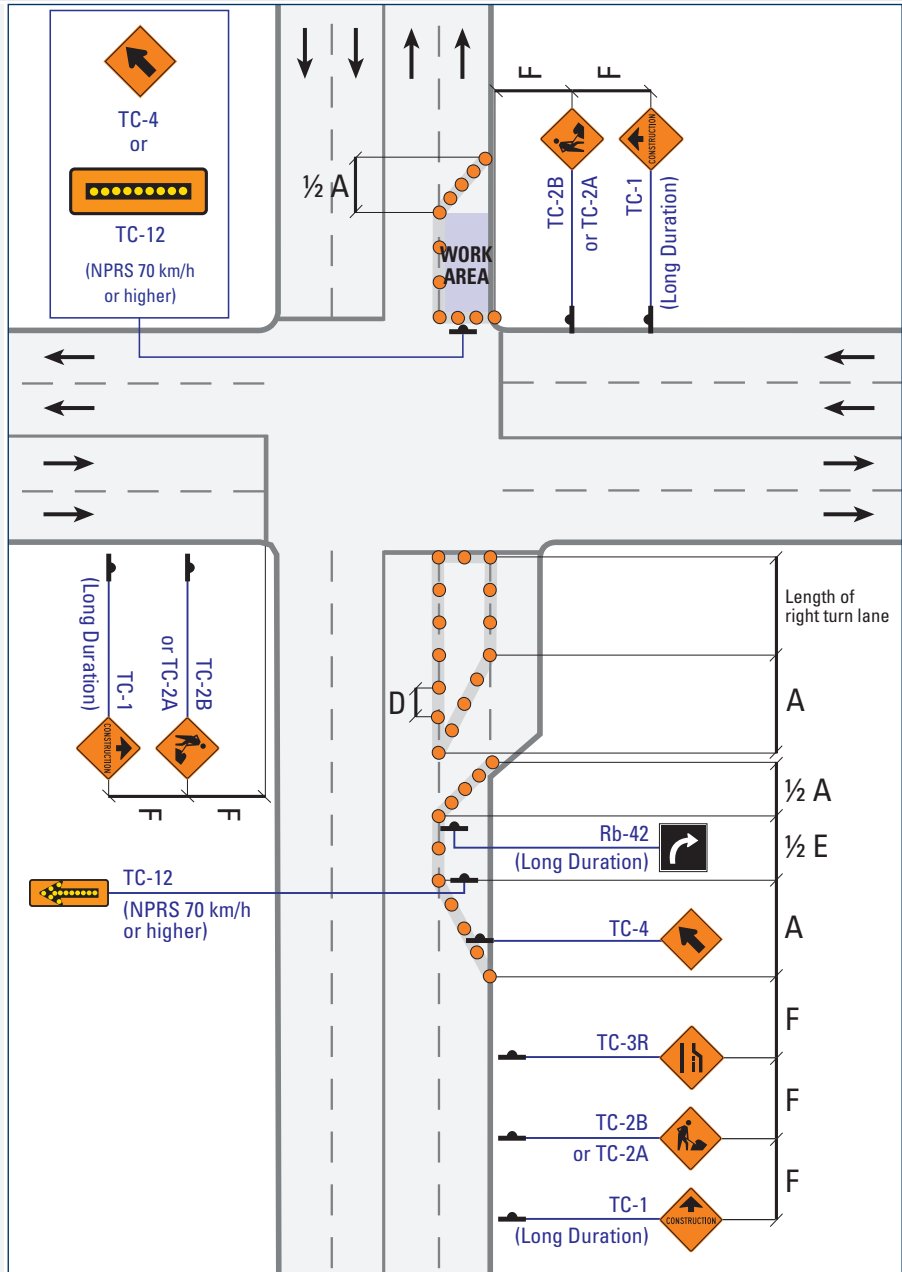

Normal Posted Regulatory Speed (km/h)

Label	Description	50	60	70	80	90
A	Taper Length for Full Lane Closure (m)	60	85	155	180	200
D	Maximum Distance between Markers (m)	6	9	9	12	12
	Minimum Number of Markers for Taper	5	7	9	11	13
E	Minimum Tangent between Tapers (m)	60	85	155	180	200
F	Distance between Construction Signs (m)	50	90	120	140	150

**UI-18**

**Intersection: (Left Turn Lane Open) Far-Side Left Lane Closed**

**Multi-Lane Undivided**

Mobile Operations

Intermittent

Very Short Duration

Short Duration

Long Duration

**NOTES**

i) If space permits, use TC-53A or TC-53B to surround the Work Area, otherwise reduce spacing between TC-54.

ii) It may be necessary to prohibit right turn truck movements.

For further detail on Work Zone components, see [Table B \(Short/Long, pg. 241\)](#).

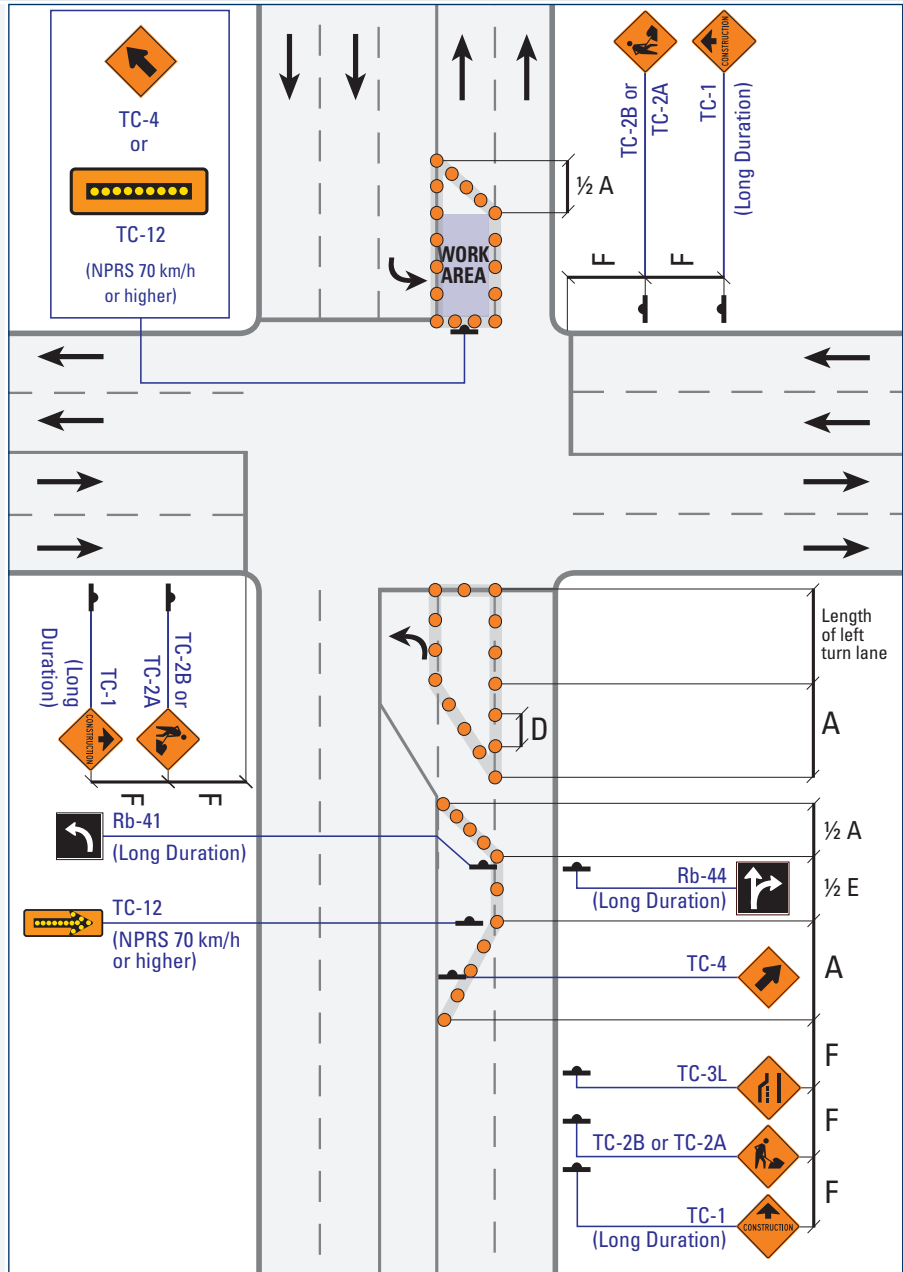

Normal Posted Regulatory Speed (km/h)

Label	Description	50	60	70	80	90
<b>A</b>	Taper Length for Full Lane Closure (m)	60	85	155	180	200
<b>D</b>	Maximum Distance between Markers (m)	6	9	9	12	12
	Minimum Number of Markers for Taper	5	7	9	11	13
<b>E</b>	Minimum Tangent between Tapers (m)	60	85	155	180	200
<b>F</b>	Distance between Construction Signs (m)	50	90	120	140	150

**UI-19 Intersection: Right Turn Lane and Adjacent Through Lanes Closed**

**Multi-Lane Undivided** Mobile Operations Intermittent **Very Short Duration** Short Duration Long Duration

**NOTES**

i) If space permits, use TC-53A or TC-53B to surround the Work Area, otherwise reduce spacing between TC-54.

For further detail on Work Zone components, see [Table A \(Mobile/Intermittent/Very Short, pg. 240\)](#).

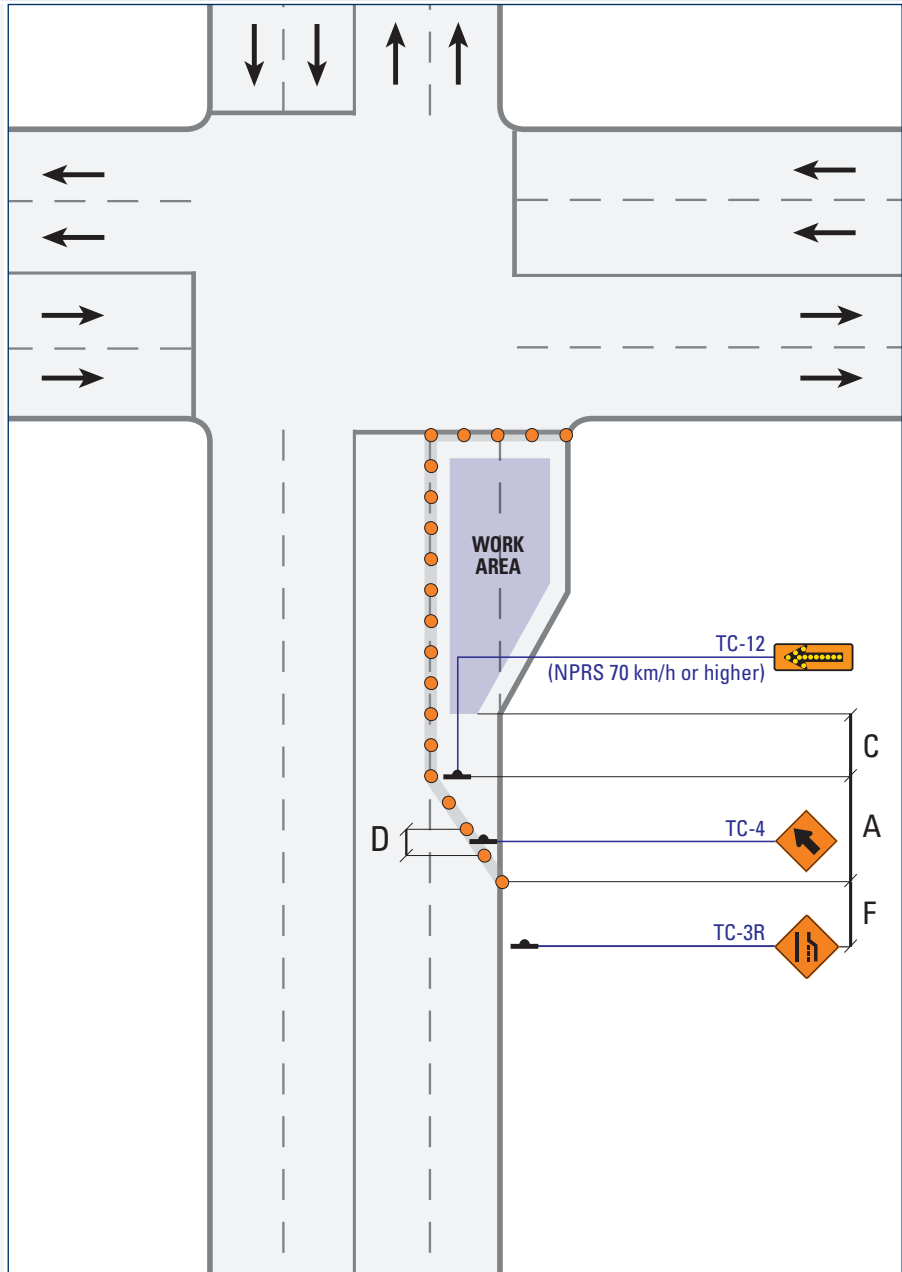

Label	Description	Normal Posted Regulatory Speed (km/h)				
		50	60	70	80	90
<b>A</b>	Taper Length for Full Lane Closure (m)	60	85	100	100	110
<b>C</b>	Longitudinal Buffer Area (LBA) (m)	(30)	(40)	50	60	75
<b>D</b>	Maximum Distance between Markers (m)	6	6	9	9	12
	Minimum Number of Markers for Taper	4	5	5	7	8
<b>F</b>	Distance between Construction Signs (m)	30	30	60	60	80

**UI-20**

**Intersection: Right Turn Lane and Adjacent Through Lanes Closed**

**Multi-Lane Undivided**

Mobile Operations

Intermittent

Very Short Duration

Short Duration

Long Duration

**NOTES**

i) If space permits, use TC-53A or TC-53B to surround the Work Area, otherwise reduce spacing between TC-54.

For further detail on Work Zone components, see [Table B \(Short/Long, pg. 241\)](#).

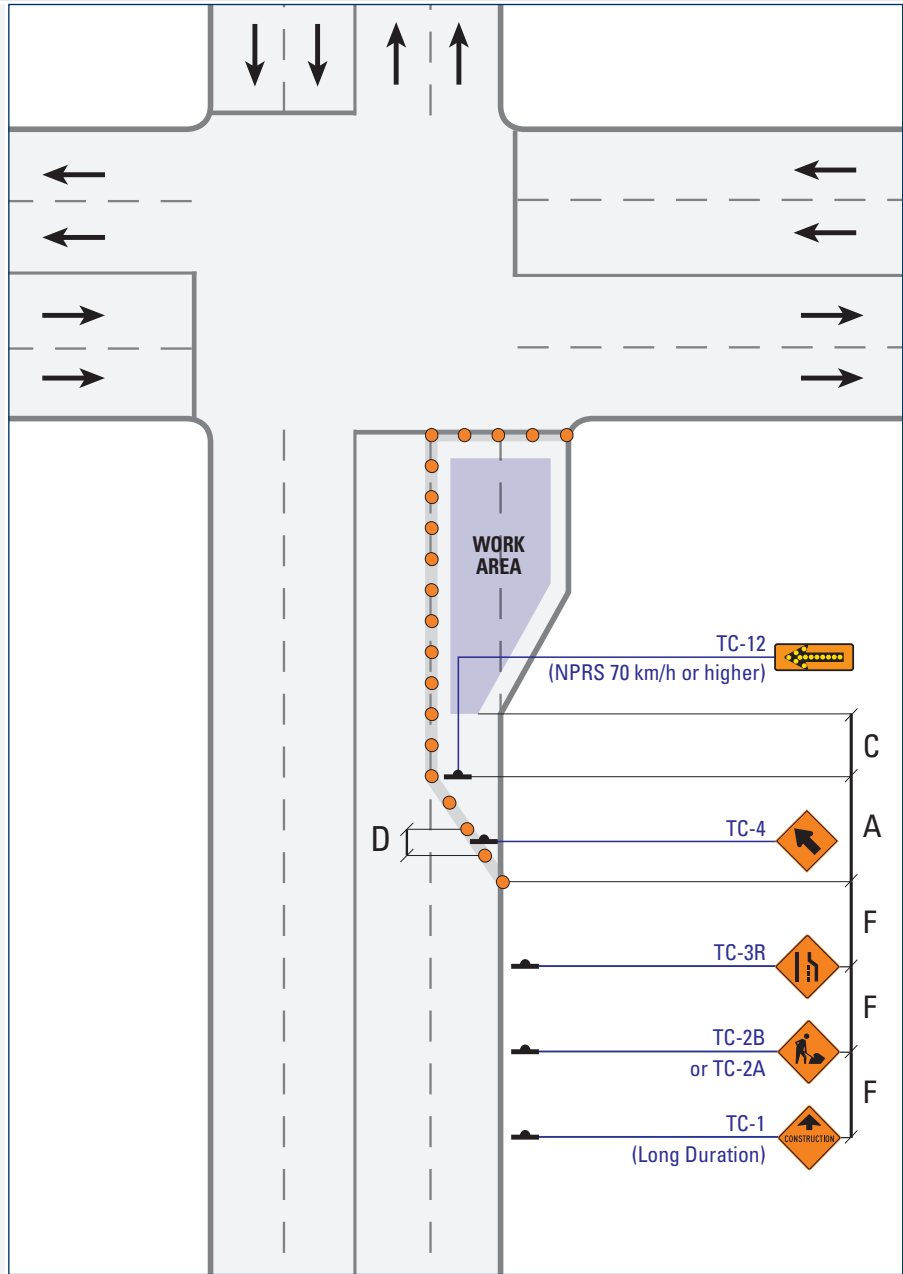

Normal Posted Regulatory Speed (km/h)

Label	Description	50	60	70	80	90
<b>A</b>	Taper Length for Full Lane Closure (m)	60	85	155	180	200
<b>C</b>	Longitudinal Buffer Area (LBA) (m)	(30)	(40)	50	60	75
<b>D</b>	Maximum Distance between Markers (m)	6	9	9	12	12
	Minimum Number of Markers for Taper	5	7	9	11	13
<b>F</b>	Distance between Construction Signs (m)	50	90	120	140	150

**UI-21 Intersection: Left Turn Lane and Adjacent Through Lanes Closed**

**Multi-Lane Undivided**

Mobile Operations

Intermittent

**Very Short Duration**

Short Duration

Long Duration

**NOTES**

i) If space permits, use TC-53A or TC-53B to surround the Work Area, otherwise reduce spacing between TC-54.

ii) It may be necessary to prohibit left turns in the direction reduced to one lane.

For further detail on Work Zone components, see [Table A \(Mobile/Intermittent/Very Short, pg. 240\)](#).

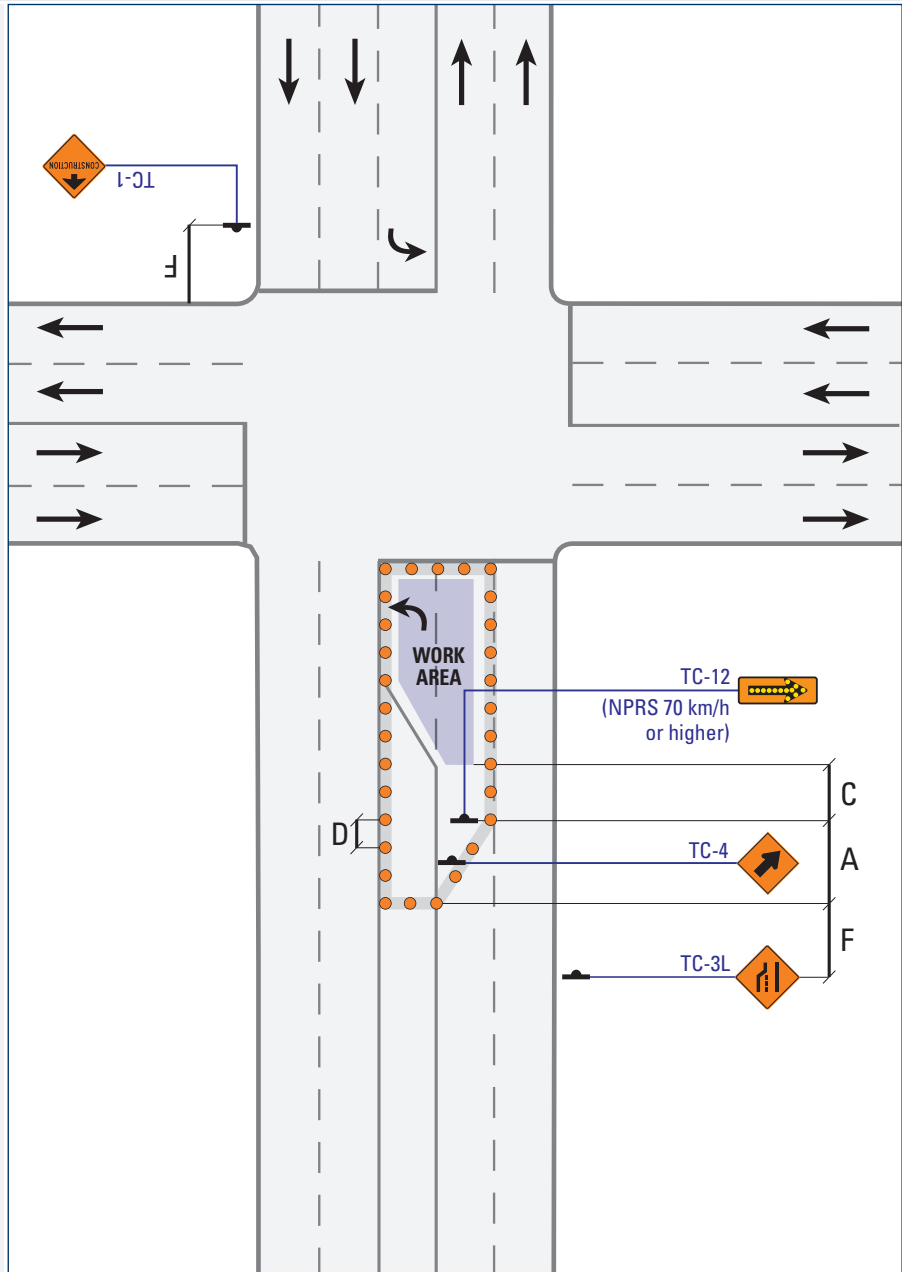

Label	Description	Normal Posted Regulatory Speed (km/h)				
		50	60	70	80	90
<b>A</b>	Taper Length for Full Lane Closure (m)	60	85	100	100	110
<b>C</b>	Longitudinal Buffer Area (LBA) (m)	(30)	(40)	50	60	75
<b>D</b>	Maximum Distance between Markers (m)	6	6	9	9	12
	Minimum Number of Markers for Taper	4	5	5	7	8
<b>F</b>	Distance between Construction Signs (m)	30	30	60	60	80

**UI-22**

**Intersection: Left Turn Lane and Adjacent Through Lanes Closed**

**Multi-Lane Undivided**

Mobile Operations

Intermittent

Very Short Duration

Short Duration

Long Duration

**NOTES**

- i) If space permits, use TC-53A or TC-53B to surround the Work Area, otherwise reduce spacing between TC-54.
- ii) It may be necessary to prohibit left turns in the direction reduced to one lane.

For further detail on Work Zone components, see [Table B \(Short/Long, pg. 241\)](#).

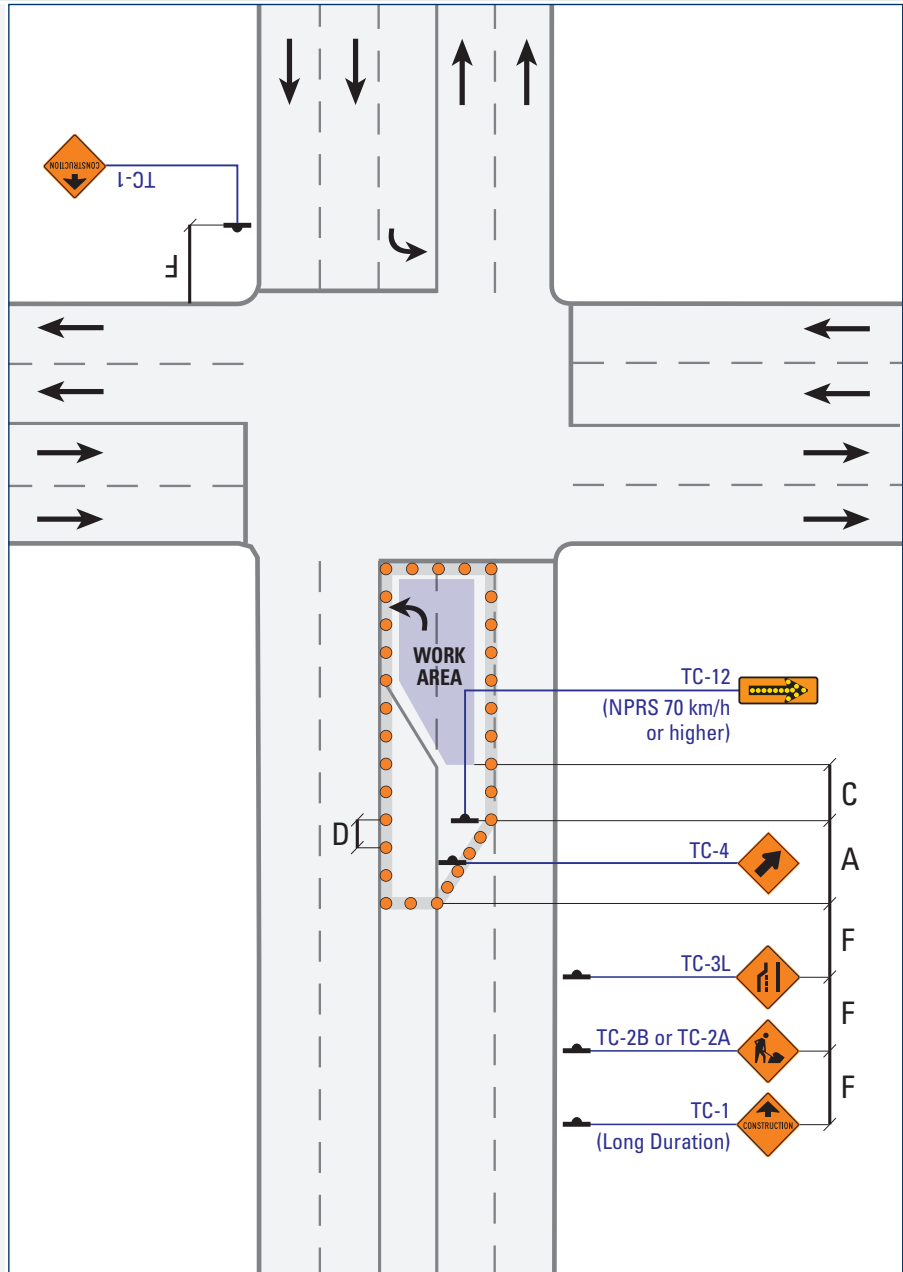

Normal Posted Regulatory Speed (km/h)

Label	Description	50	60	70	80	90
<b>A</b>	Taper Length for Full Lane Closure (m)	60	85	155	180	200
<b>C</b>	Longitudinal Buffer Area (LBA) (m)	(30)	(40)	50	60	75
<b>D</b>	Maximum Distance between Markers (m)	6	9	9	12	12
	Minimum Number of Markers for Taper	5	7	9	11	13
<b>F</b>	Distance between Construction Signs (m)	50	90	120	140	150

**UI-23 Work in Intersection: Right Lane Closed**

**Multi-Lane Undivided**

Mobile Operations    Intermittent    Very Short Duration    **Short Duration**    Long Duration

**NOTES**

i) If space permits, use TC-53A or TC-53B to surround the Work Area, otherwise reduce spacing between TC-54.

ii) It may be necessary to prohibit certain turning movements.

iii) Flashing Amber Light above TC-7 must not be used at intersections with active signals.

\*The TC-4 sign must be installed at or just beyond the beginning of a lane closure taper.

For further detail on Work Zone components, see [Table B \(Short/Long, pg. 241\)](#).

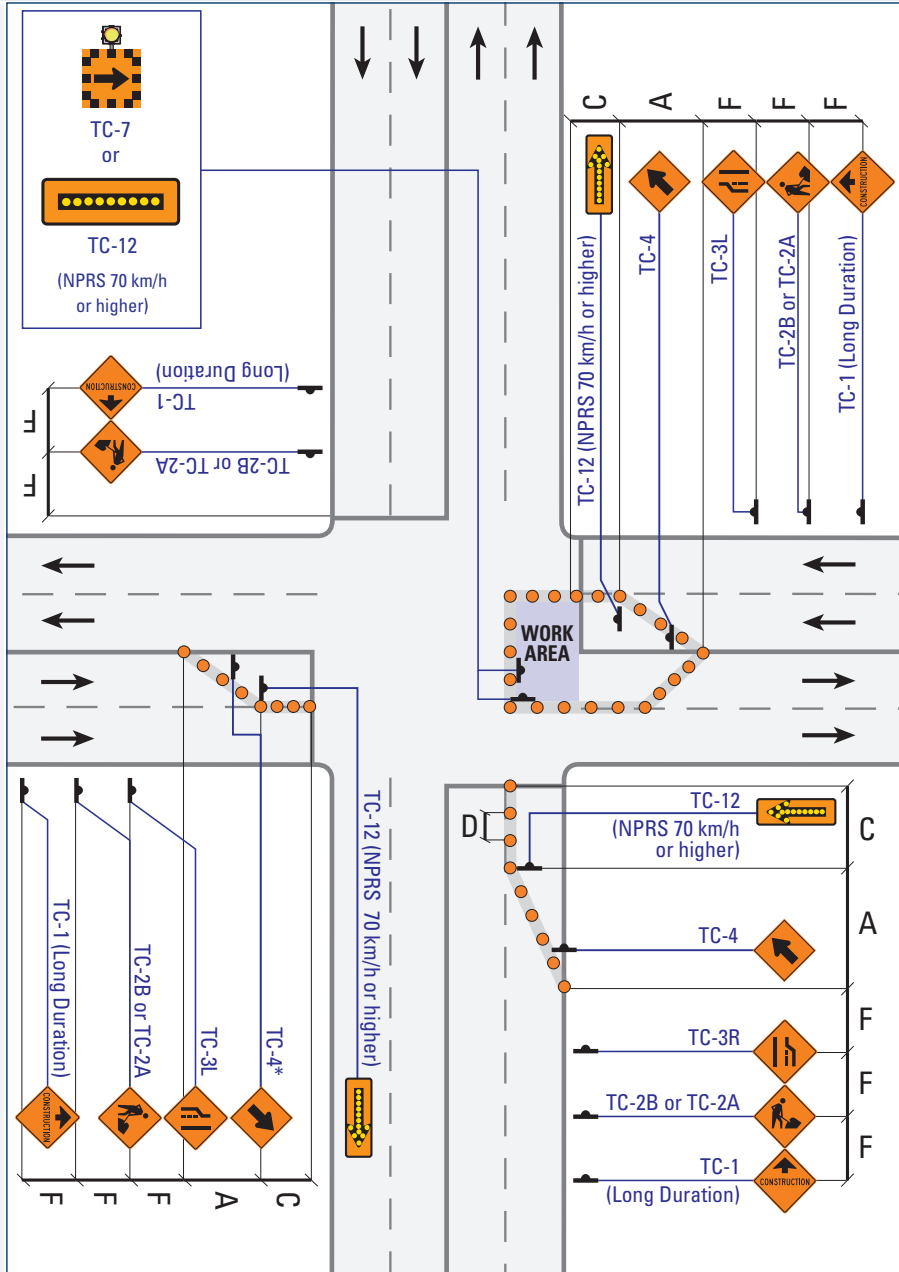

Label	Description	Normal Posted Regulatory Speed (km/h)				
		50	60	70	80	90
<b>A</b>	Taper Length for Full Lane Closure (m)	60	85	155	180	200
<b>C</b>	Longitudinal Buffer Area (LBA) (m)	(30)	(40)	50	60	75
<b>D</b>	Maximum Distance between Markers (m)	6	9	9	12	12
	Minimum Number of Markers for Taper	5	7	9	11	13
<b>F</b>	Distance between Construction Signs (m)	50	90	120	140	150

**UI-24 Work in Intersection: Left Lane Closed**

**Multi-Lane Undivided** Mobile Operations Intermittent Very Short Duration **Short Duration** Long Duration

**NOTES**

i) If space permits, use TC-53A or TC-53B to surround the Work Area, otherwise reduce spacing between TC-54.

ii) It may be necessary to prohibit additional turning movements.

iii) Flashing Amber Light above TC-7 must not be used at intersections with active signals.

iv) See US-25 "Route Detour", for applicable layout.

\*The TC-4 sign must be installed at or just beyond the beginning of a lane closure taper.

For further detail on Work Zone components, see [Table B \(Short/Long, pg. 241\)](#).

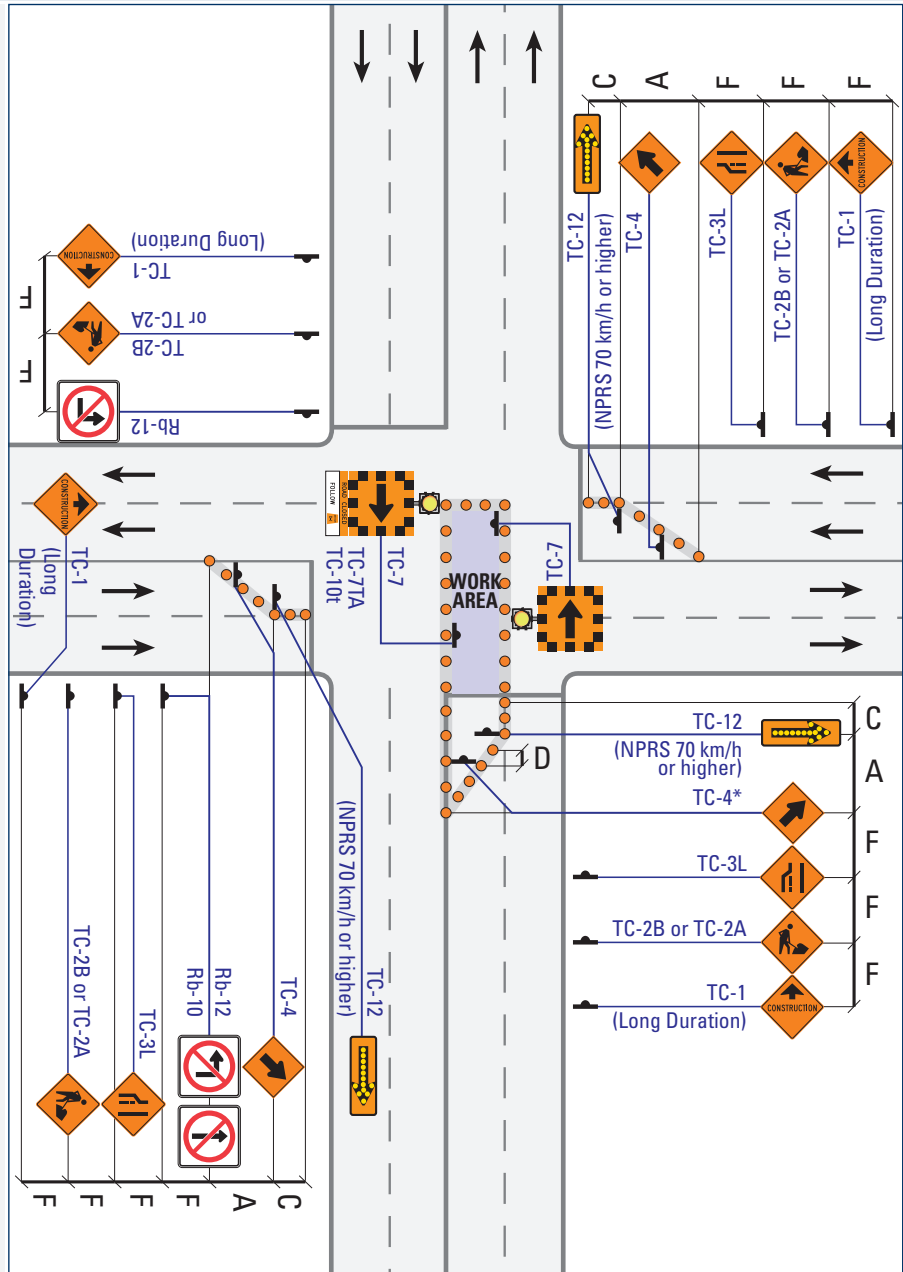

Normal Posted Regulatory Speed (km/h)

Label	Description	50	60	70	80	90
<b>A</b>	Taper Length for Full Lane Closure (m)	60	85	155	180	200
<b>C</b>	Longitudinal Buffer Area (LBA) (m)	(30)	(40)	50	60	75
<b>D</b>	Maximum Distance between Markers (m)	6	9	9	12	12
	Minimum Number of Markers for Taper	5	7	9	11	13
<b>F</b>	Distance between Construction Signs (m)	50	90	120	140	150



**UI-25 Work in Intersection: Road Closed (Detour) – Option 1**

**Multi-Lane Undivided** Mobile Operations Intermittent Very Short Duration Short Duration Long Duration

**NOTES**

i) If space permits, use TC-53A or TC-53B to surround the Work Area, otherwise reduce spacing between TC-54.

ii) Flashing Amber Light above TC-7 must not be used at intersections with active signals.

iii) See US-25 “Route Detour”, for applicable layout.

For further detail on Work Zone components, see [Table B \(Short/Long, pg. 241\)](#).

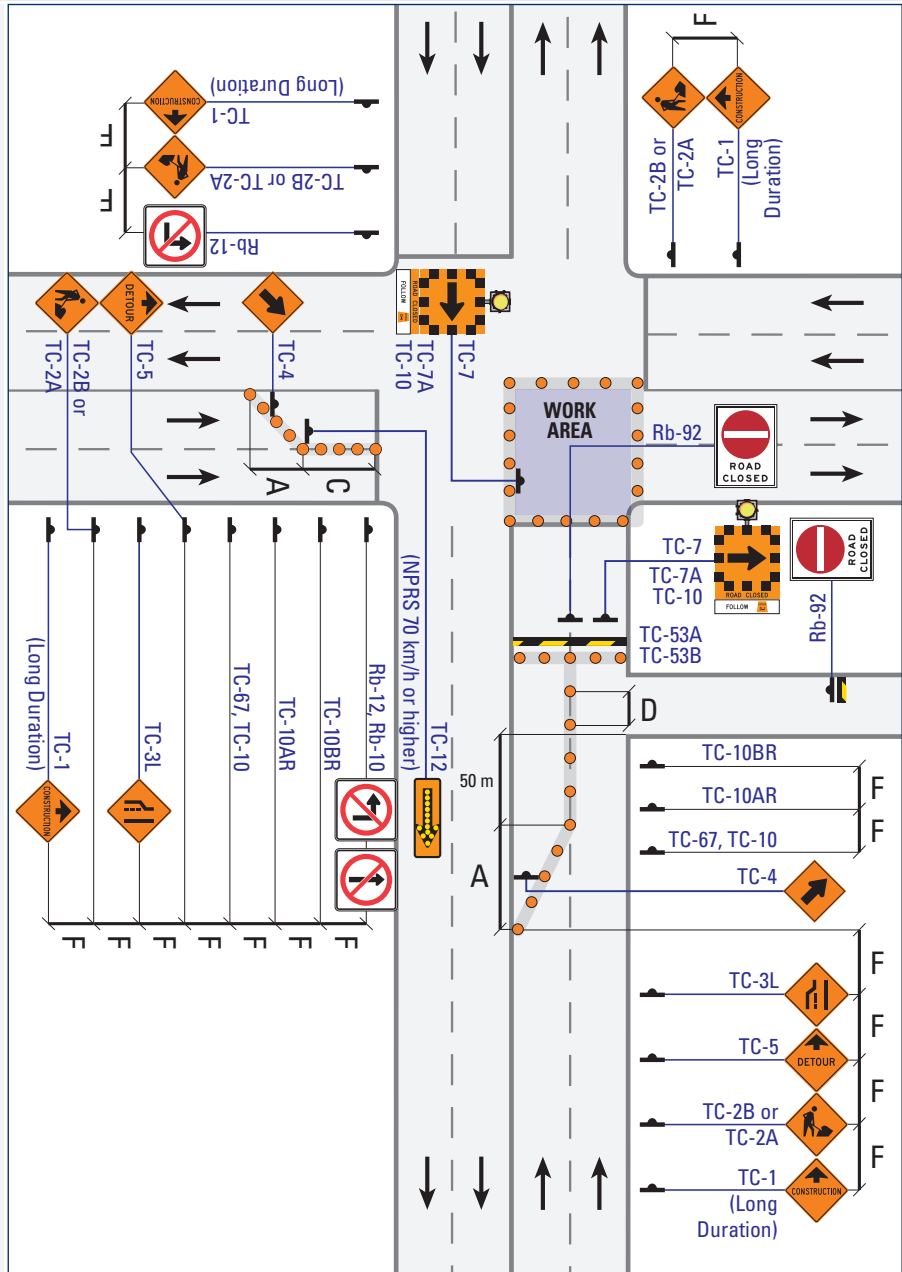

Normal Posted Regulatory Speed (km/h)

Label	Description	50	60	70	80	90
<b>A</b>	Taper Length for Full Lane Closure (m)	60	85	155	180	200
<b>C</b>	Longitudinal Buffer Area (LBA) (m)	(30)	(40)	50	60	75
<b>D</b>	Maximum Distance between Markers (m)	6	9	9	12	12
	Minimum Number of Markers for Taper	5	7	9	11	13
<b>F</b>	Distance between Construction Signs (m)	50	90	120	140	150



**UI-27 Pedestrian Accommodation: Intersection Sidewalk Detour onto Roadway**

**Multi-Lane Undivided** Mobile Operations Intermittent Very Short Duration Short Duration Long Duration

**NOTES**

- i) For Sidewalk Closures of Long Duration, a boardwalk and railing should be provided instead of Pedestrian Barricades.
  - ii) Minimum width of the temporary walkway is 1.2 m.
  - iii) AODA-compliant ramps are required if the curb is raised.
- For further detail on Work Zone components, see [Table B \(Short/Long, pg. 241\)](#).

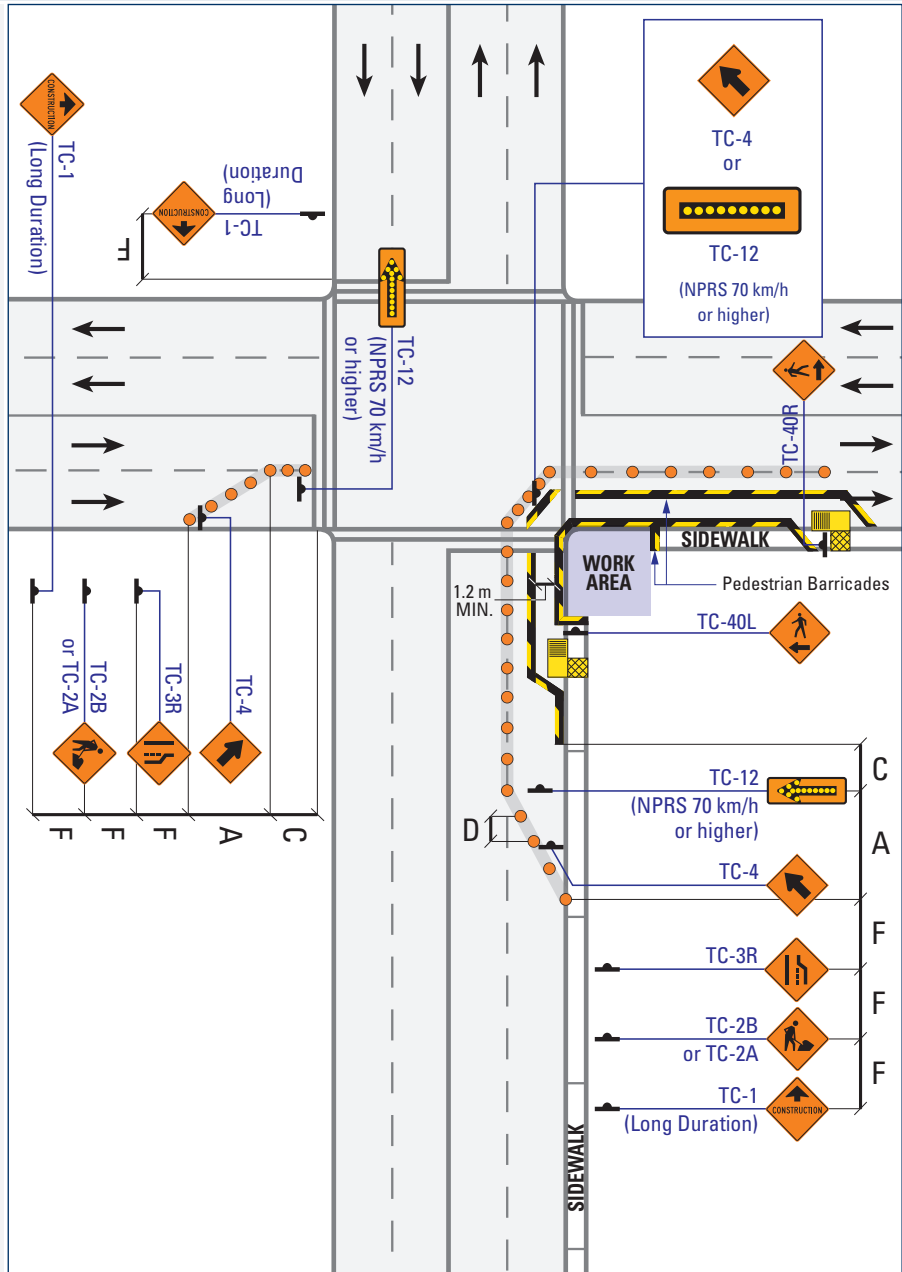

Label	Description	Normal Posted Regulatory Speed (km/h)				
		50	60	70	80	90
<b>A</b>	Taper Length for Full Lane Closure (m)	60	85	155	180	200
<b>C</b>	Longitudinal Buffer Area (LBA) (m)	(30)	(40)	50	60	75
<b>D</b>	Maximum Distance between Markers (m)	6	9	9	12	12
	Minimum Number of Markers for Taper	5	7	9	11	13
<b>F</b>	Distance between Construction Signs (m)	50	90	120	140	150

**UI-28 Pedestrian Detour: Crosswalk Closure**

**Multi-Lane Undivided** Mobile Operations Intermittent Very Short Duration **Short Duration** Long Duration

**NOTES**

i) Supplementary layout. This layout shows pedestrian signage only and shall be used in conjunction with other appropriate layouts.

ii) See US-25 & US-26 for required signage for vehicle Detour.

For further detail on Work Zone components, see [Table B \(Short/Long, pg. 241\)](#).

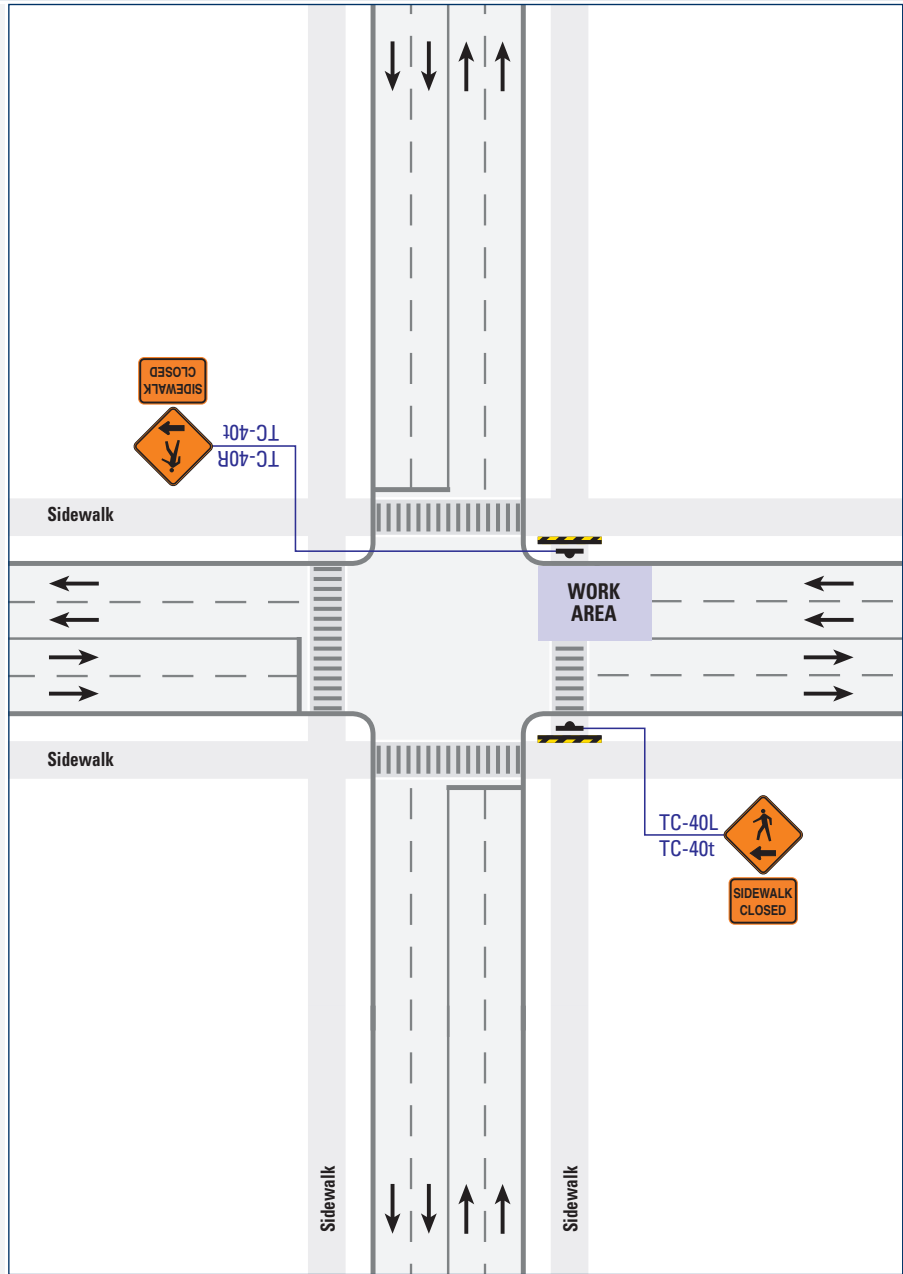

**UI-29 Pedestrian Detour: Crosswalk and Sidewalk Closure**

**Multi-Lane Undivided**

Mobile Operations

Intermittent

Very Short Duration

**Short Duration**

Long Duration

**NOTES**

i) TC-40L/R Pedestrian Direction sign must be placed at the nearest upstream controlled pedestrian crossing (traffic signal of Pedestrian Crossover) in each direction.

For further detail on Work Zone components, see [Table B \(Short/Long, pg. 241\)](#).

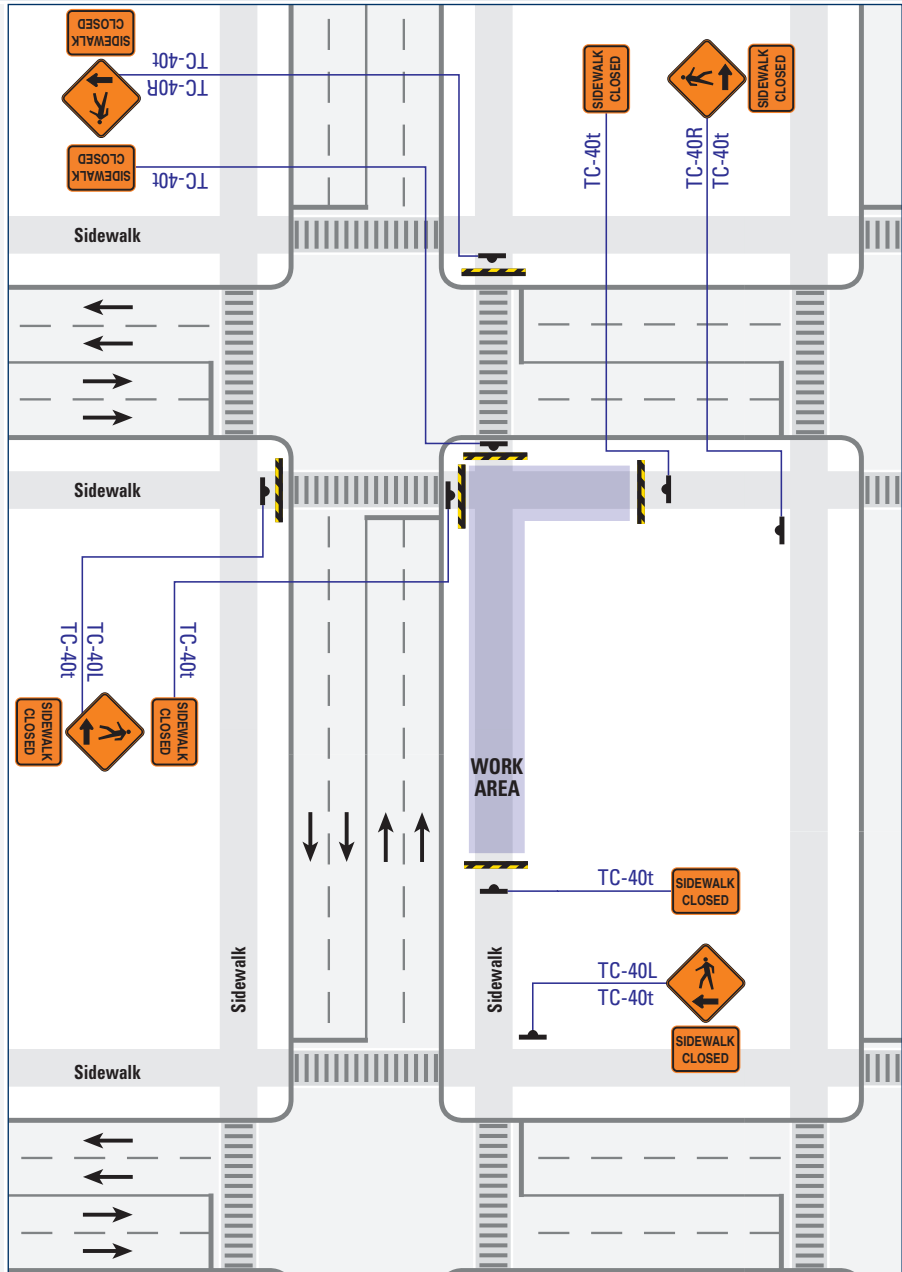

**UI-30**

**Cyclist: Detour**

**Multi-Lane Undivided**

Mobile Operations

Intermittent

Very Short Duration

Short Duration

Long Duration

**NOTES**

Shared lane only to be used if considered by OTM Book 18 or MTO Bikeways Design Manual, Desirable Cycling Facility Nomograph. Otherwise, cycling Detour should be provided.

For further detail on Work Zone components, see Table B (Short/Long, pg. 241).

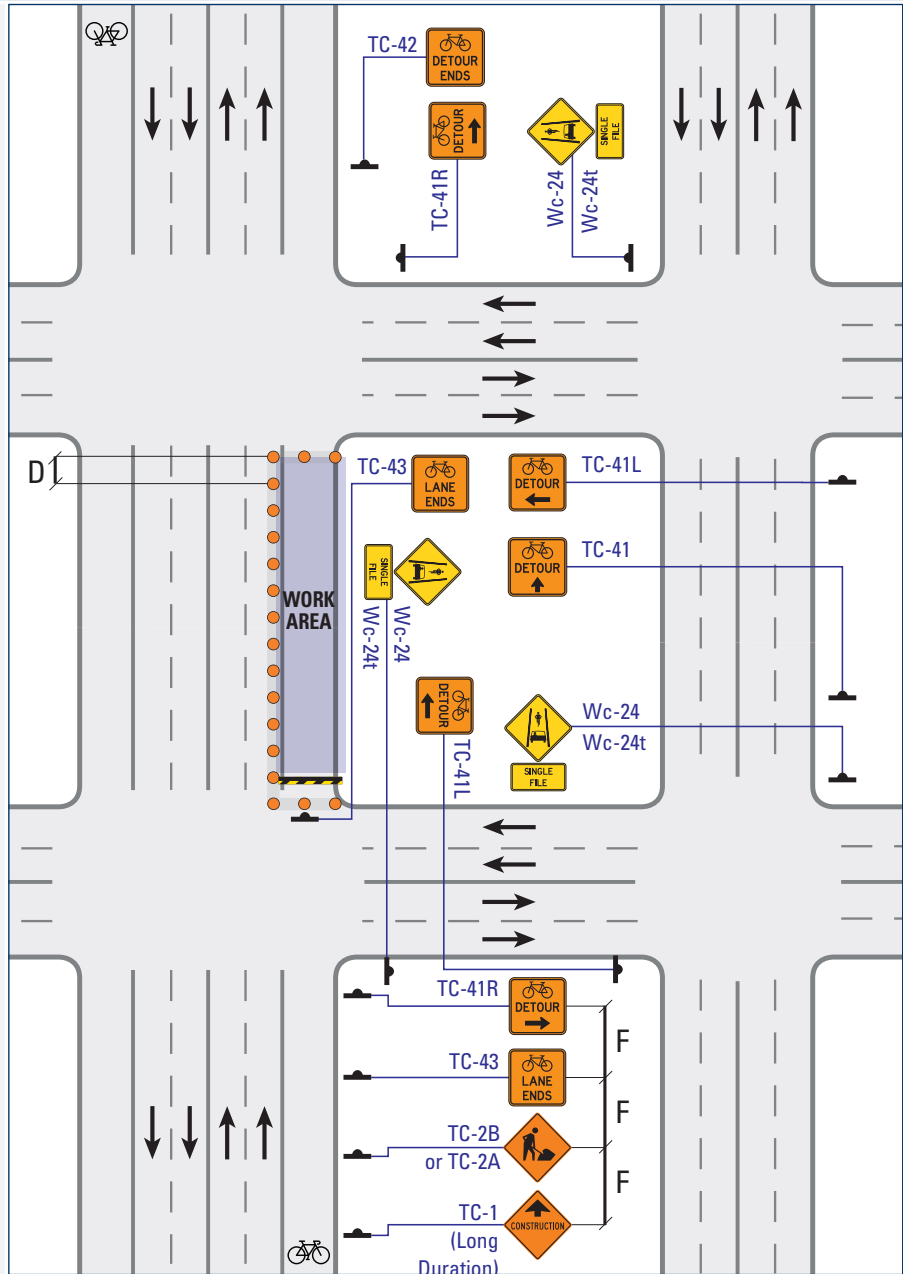

Normal Posted Regulatory Speed (km/h)

Label	Description	50	60	70	80	90
<b>D</b>	Maximum Distance between Markers (m)	6	9	9	12	12
<b>F</b>	Distance between Construction Signs (m)	50	90	120	140	150

**UI-31 Bicycle Lane Closed: Dismount and Walk**

**Multi-Lane Undivided**

Mobile Operations

Intermittent

Very Short Duration

Short Duration

Long Duration

**NOTES**

i) Supplementary layout. This layout shows cyclist signage only and shall be used in conjunction with other appropriate layouts.

ii) See US-25 & US-26 for required signage for vehicle Detour.

iii) Ramps must be AODA-compliant.

For further detail on Work Zone components, see [Table B \(Short/Long, pg. 241\)](#).

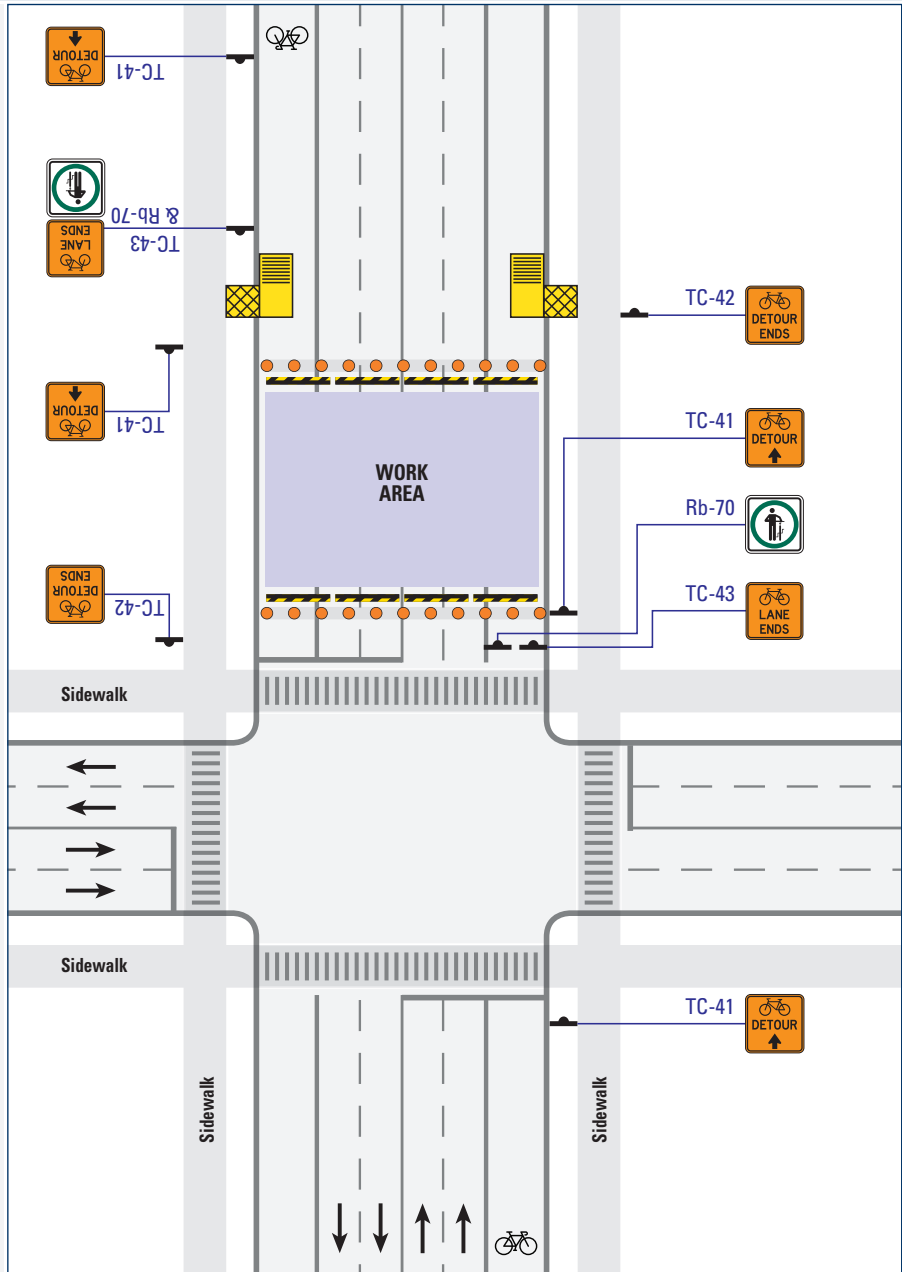

**UO-1 Roundabout: Encroachment**

**Multi-Lane Undivided** Mobile Operations Intermittent **Very Short Duration** Short Duration Long Duration

**NOTES**

- i) It may be necessary to leave a wider lane width if there is a high truck percentage.
- ii) Total lane width of 10 m must be maintained. If minimum lane widths cannot be maintained then see Lane Closure layouts.
- iii) Markers are not required if a Work Vehicle with Beacon + 4WF or TC-12 is present.

For further detail on Work Zone components, see [Table A \(Mobile/Intermittent/Very Short, pg. 240\)](#).

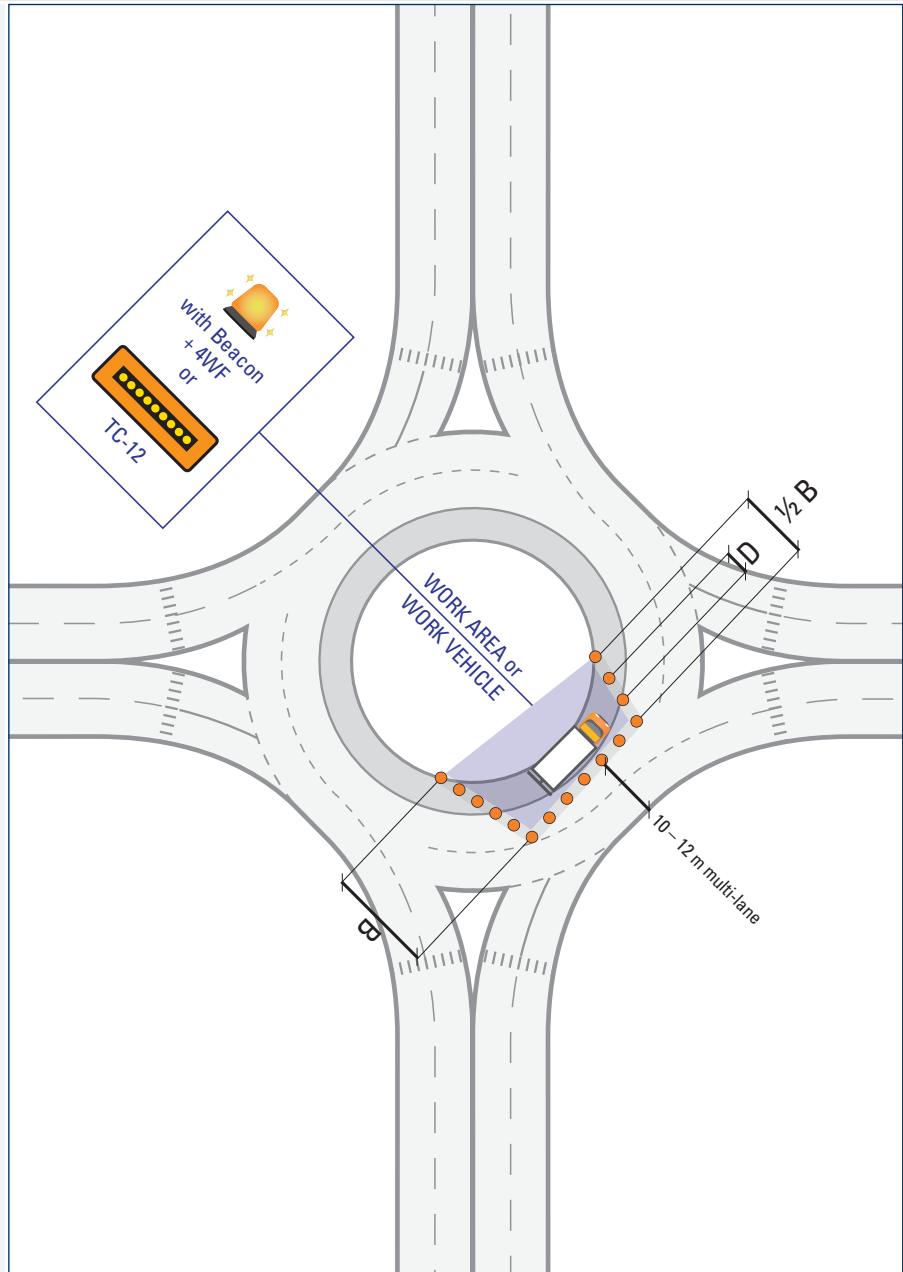

Label	Description	Normal Posted Regulatory Speed (km/h)				
		50	60	70	80	90
<b>B</b>	Shoulder Taper (m)	20	30	35	35	40
<b>D</b>	Maximum Distance between Markers (m)	6	6	9	9	12
	Minimum Number of Markers for Taper	4	5	5	7	8



**UO-2 Roundabout: Encroachment**

**Multi-Lane Undivided** Mobile Operations Intermittent Very Short Duration **Short Duration** Long Duration

**NOTES**

- i) It may be necessary to leave a wider lane width if there is a high truck percentage.
- ii) Total lane width of 10 m must be maintained. If minimum lane widths cannot be maintained then see Lane Closure layouts.

\*The TC-4 sign must be installed at or just beyond the beginning of a lane closure taper.

For further detail on Work Zone components, see [Table B \(Short/Long, pg. 241\)](#).

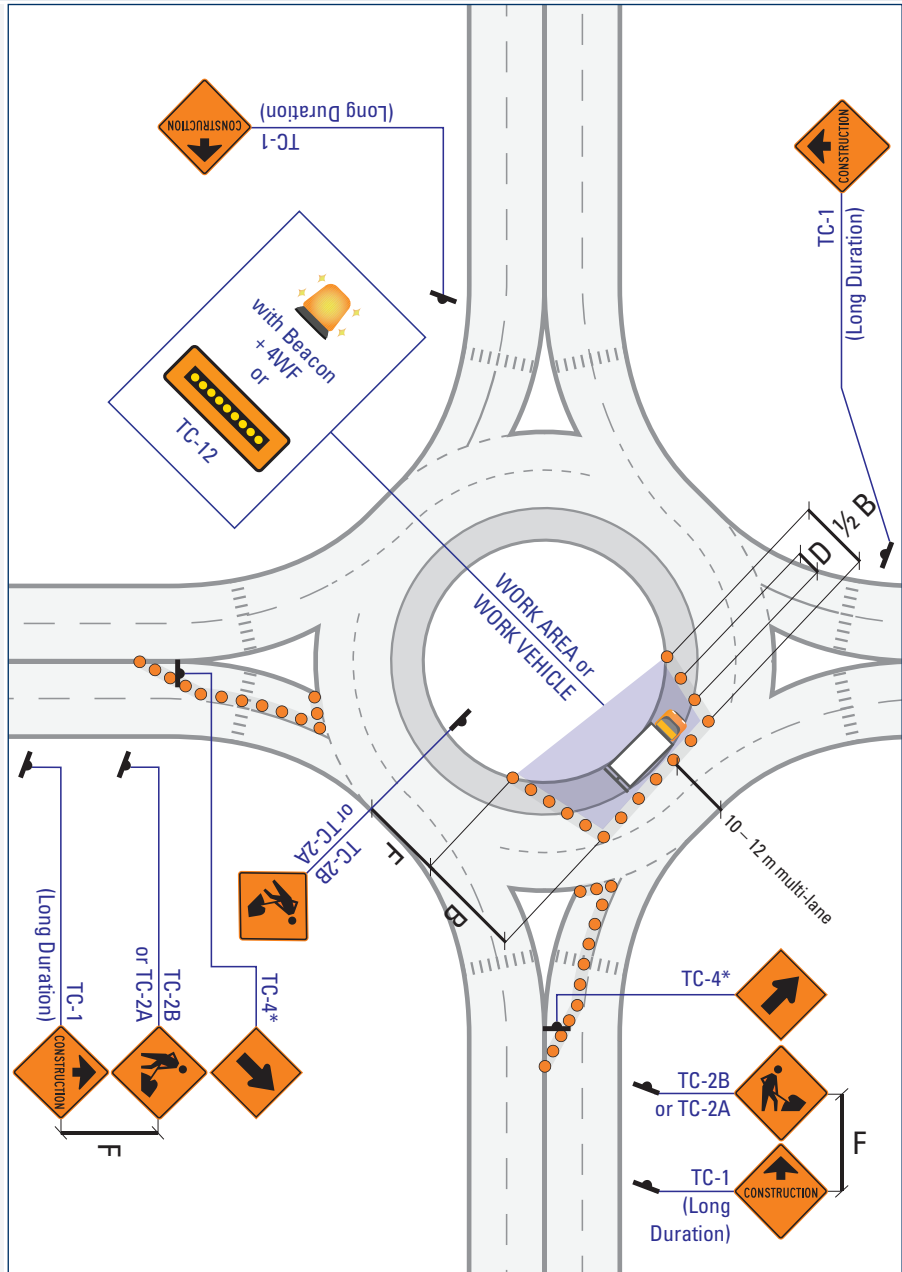

Label	Description	Normal Posted Regulatory Speed (km/h)				
		50	60	70	80	90
<b>B</b>	Shoulder Taper (m)	20	30	55	60	70
<b>D</b>	Maximum Distance between Markers (m)	6	9	9	12	12
	Minimum Number of Markers for Taper	5	7	9	11	13
<b>F</b>	Distance between Construction Signs (m)	50	90	120	140	150

**UO-3 Roundabout: Inside Lane Partially Closed**

**Multi-Lane Undivided** Mobile Operations Intermittent **Very Short Duration** Short Duration Long Duration

**NOTES**

i) It may be necessary to leave a wider lane width if there is a high truck percentage.

For further detail on Work Zone components, see [Table A \(Mobile/Intermittent/Very Short, pg. 240\)](#).

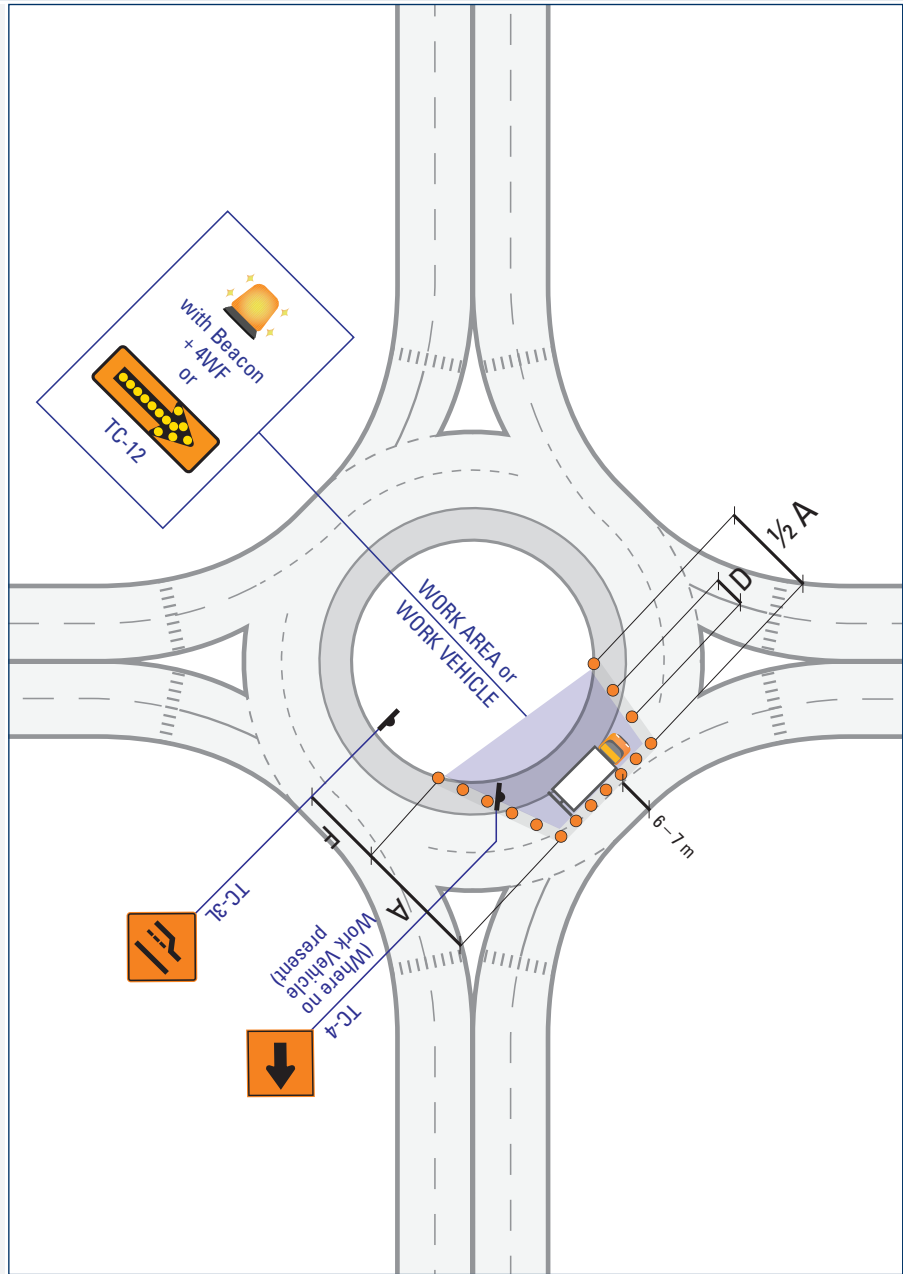

Normal Posted Regulatory Speed (km/h)

Label	Description	Normal Posted Regulatory Speed (km/h)				
		50	60	70	80	90
<b>A</b>	Taper Length for Full Lane Closure (m)	60	85	100	100	110
<b>D</b>	Maximum Distance between Markers (m)	6	6	9	9	12
	Minimum Number of Markers for Taper	4	5	5	7	8
<b>F</b>	Distance between Construction Signs (m)	30	30	60	60	80

**UO-4 Roundabout: Outside Lane Partially Closed**

**Multi-Lane Undivided** Mobile Operations Intermittent **Very Short Duration** Short Duration Long Duration

**NOTES**

i) It may be necessary to leave a wider lane width if there is a high truck percentage.

For further detail on Work Zone components, see [Table A \(Mobile/Intermittent/Very Short, pg. 240\)](#).

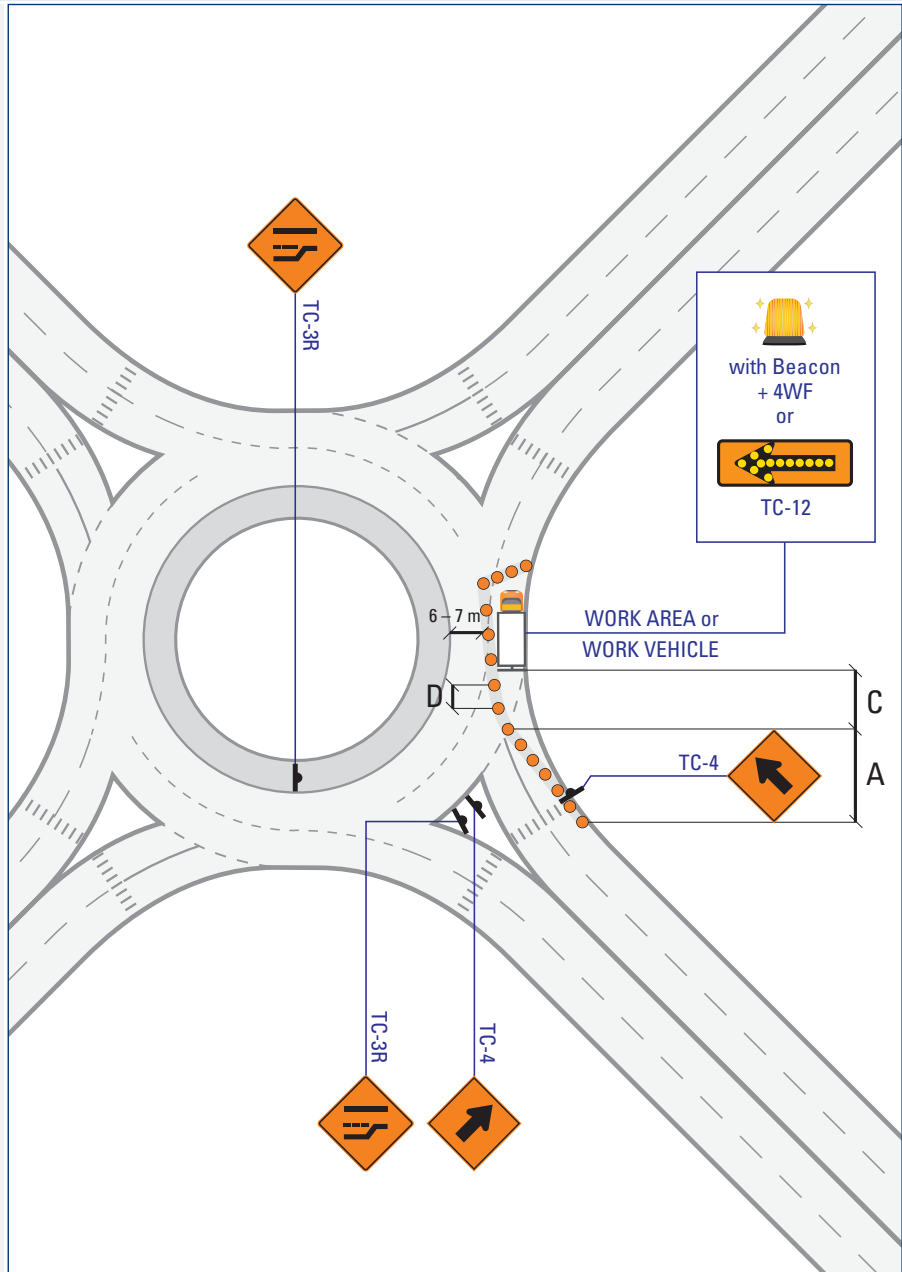

Label	Description	Normal Posted Regulatory Speed (km/h)				
		50	60	70	80	90
<b>A</b>	Taper Length for Full Lane Closure (m)	60	85	100	100	110
<b>C</b>	Longitudinal Buffer Area (LBA) (m)	(30)	(40)	50	60	75
<b>D</b>	Maximum Distance between Markers (m)	6	6	9	9	12
	Minimum Number of Markers for Taper	4	5	5	7	8

**UO-5 Roundabout: Left Exit or Partial Outside Lane Closed**

**Multi-Lane Undivided** Mobile Operations Intermittent **Very Short Duration** Short Duration Long Duration

**NOTES**

i) It may be necessary to leave a wider lane width if there is a high truck percentage.

\*The TC-4 sign must be installed at or just beyond the beginning of a lane closure taper.

For further detail on Work Zone components, see [Table A \(Mobile/ Intermittent/Very Short, pg. 240\)](#).

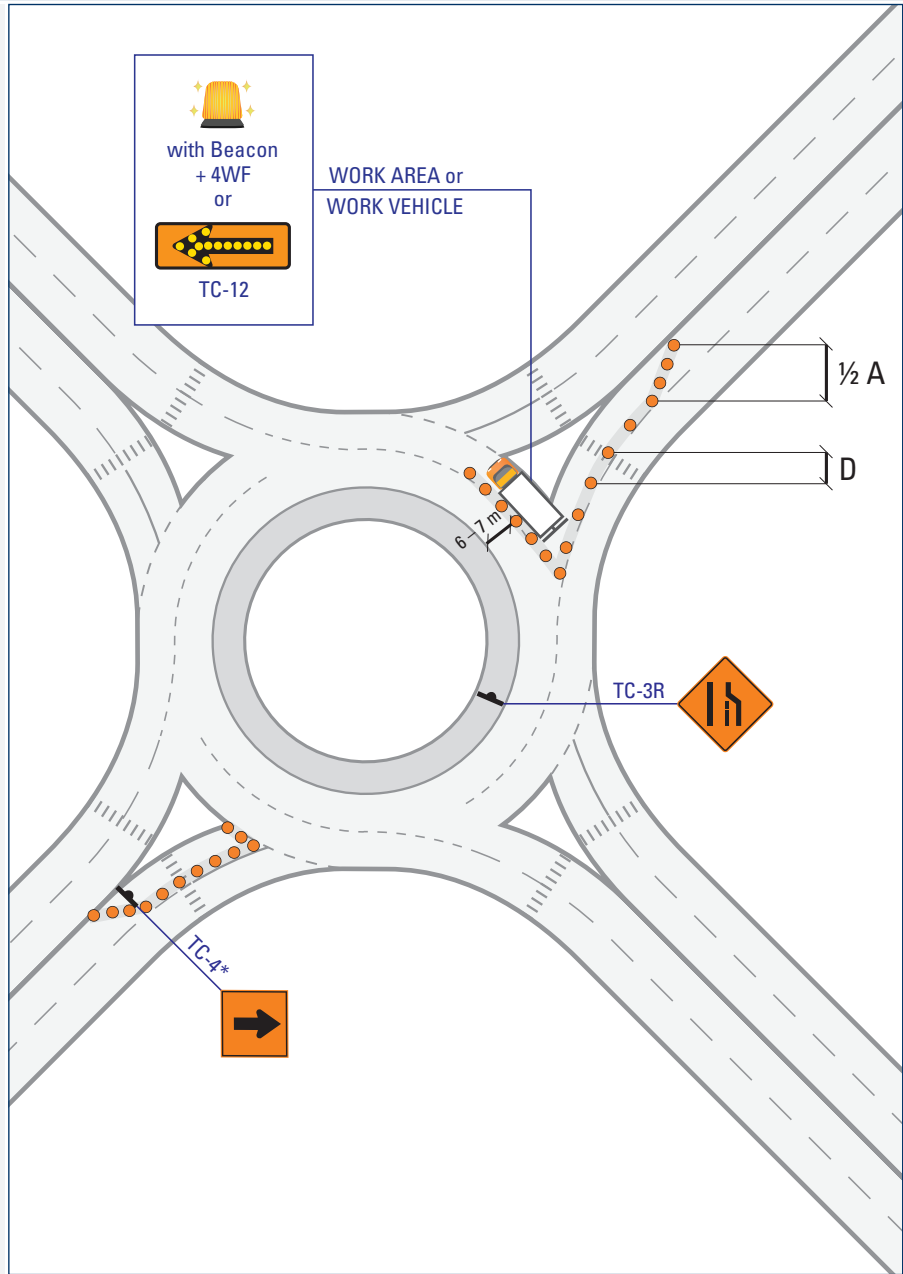

Label	Description	Normal Posted Regulatory Speed (km/h)				
		50	60	70	80	90
<b>A</b>	Taper Length for Full Lane Closure (m)	60	85	100	100	110
<b>D</b>	Maximum Distance between Markers (m)	6	6	9	12	12
	Minimum Number of Markers for Taper	4	5	5	7	8

**UO-6 Roundabout: Inside Lane Closed**

**Multi-Lane Undivided**

Mobile Operations

Intermittent

Very Short Duration

Short Duration

Long Duration

**NOTES**

i) It may be necessary to leave a wider lane width if there is a high truck percentage.

ii) Work Area may be anywhere in the inside lane. All entrances must be reduced to one lane.

\*The TC-4 sign must be installed at or just beyond the beginning of a lane closure taper.

For further detail on Work Zone components, see [Table B \(Short/Long, pg. 241\)](#).

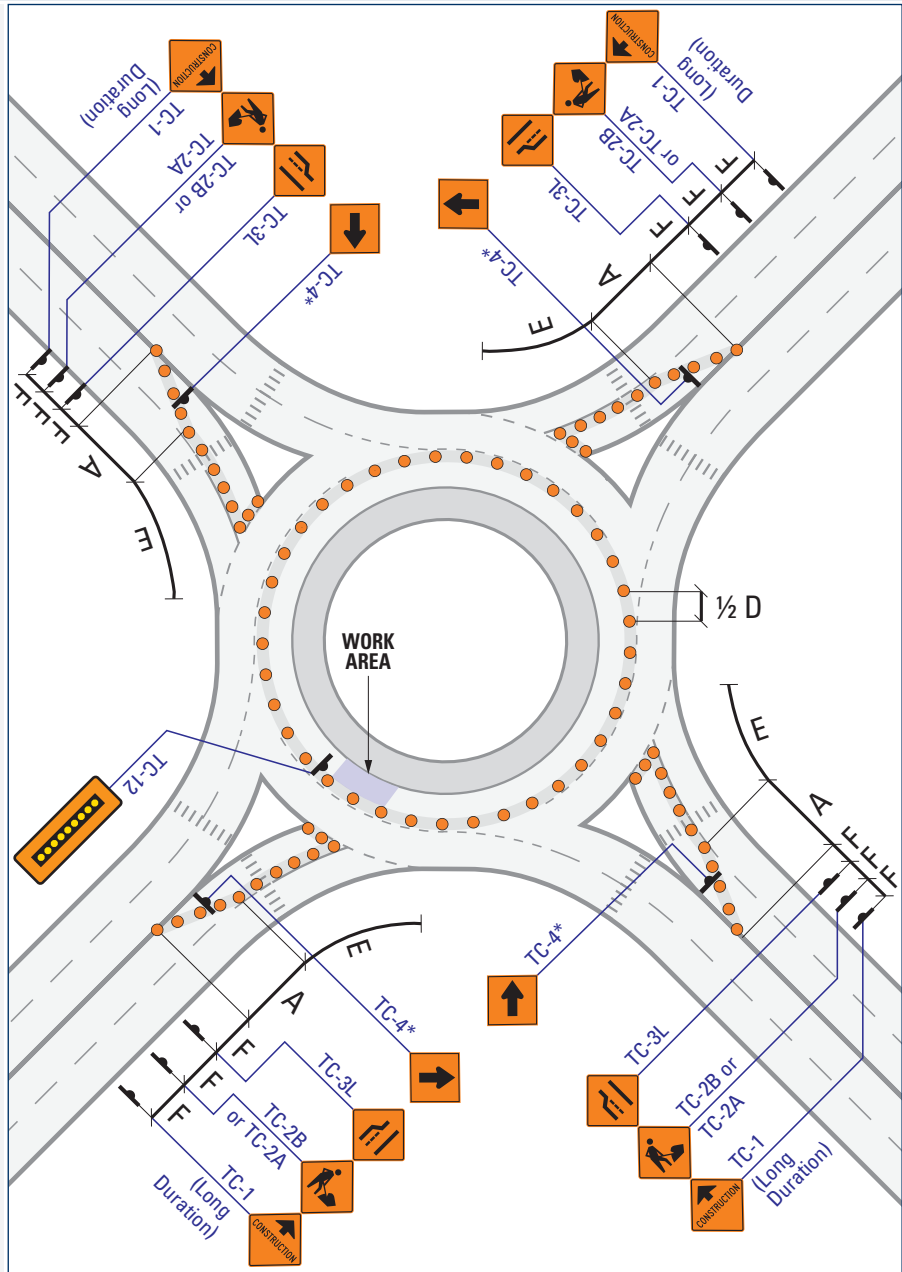

Label	Description	Normal Posted Regulatory Speed (km/h)				
		50	60	70	80	90
<b>A</b>	Taper Length for Full Lane Closure (m)	60	85	155	180	200
<b>D</b>	Maximum Distance between Markers (m)	6	9	9	12	12
	Minimum Number of Markers for Taper	5	7	9	11	13
<b>E</b>	Minimum Tangent between Tapers (m)	60	85	155	180	200
<b>F</b>	Distance between Construction Signs (m)	50	90	120	140	150

**UO-7 Roundabout: Outside Lane Closed**

**Multi-Lane Undivided** Mobile Operations Intermittent Very Short Duration **Short Duration** Long Duration

**NOTES**

i) It may be necessary to leave a wider lane width if there is a high truck percentage.

ii) Work Area may be in any of the closed quadrants. All entrances and exits must be reduced to one lane.

\*The TC-4 sign must be installed at or just beyond the beginning of a lane closure taper.

For further detail on Work Zone components, see [Table B \(Short/Long, pg. 241\)](#).

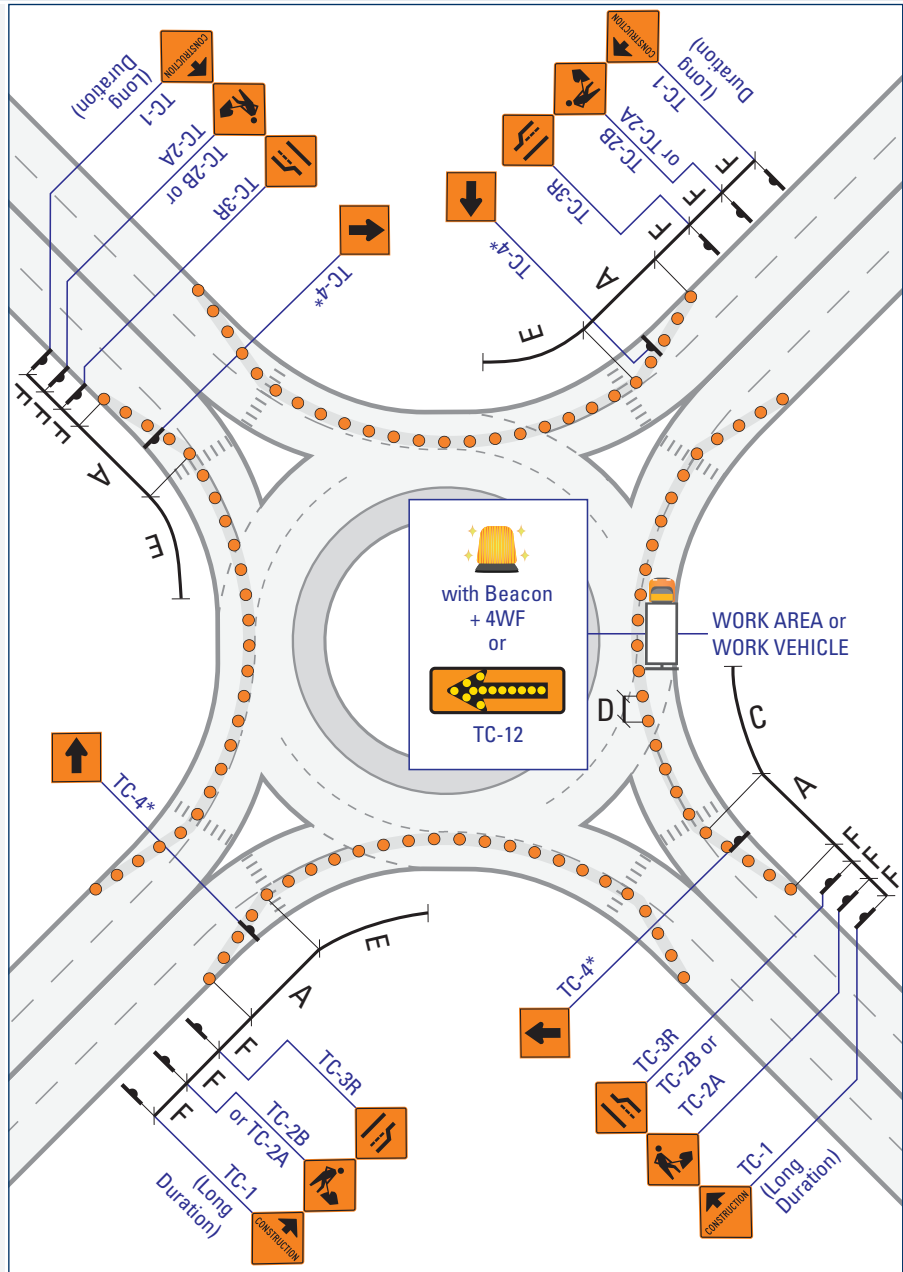

Normal Posted Regulatory Speed (km/h)

Label	Description	50	60	70	80	90
A	Taper Length for Full Lane Closure (m)	60	85	155	180	200
C	Longitudinal Buffer Area (LBA) (m)	(30)	(40)	50	60	75
D	Maximum Distance between Markers (m)	6	9	9	12	12
	Minimum Number of Markers for Taper	5	7	9	11	13
E	Minimum Tangent between Tapers (m)	60	85	155	180	200
F	Distance between Construction Signs (m)	50	90	120	140	150

**UO-8 Roundabout: Left Exit or Partial Outside Lane Closed**

**Multi-Lane Undivided** Mobile Operations Intermittent Very Short Duration **Short Duration** Long Duration

**NOTES**

- i) It may be necessary to leave a wider lane width if there is a high truck percentage.
- ii) All entrances must be reduced to one lane.

\*The TC-4 sign must be installed at or just beyond the beginning of a lane closure taper.

For further detail on Work Zone components, see [Table B \(Short/Long, pg. 241\)](#).

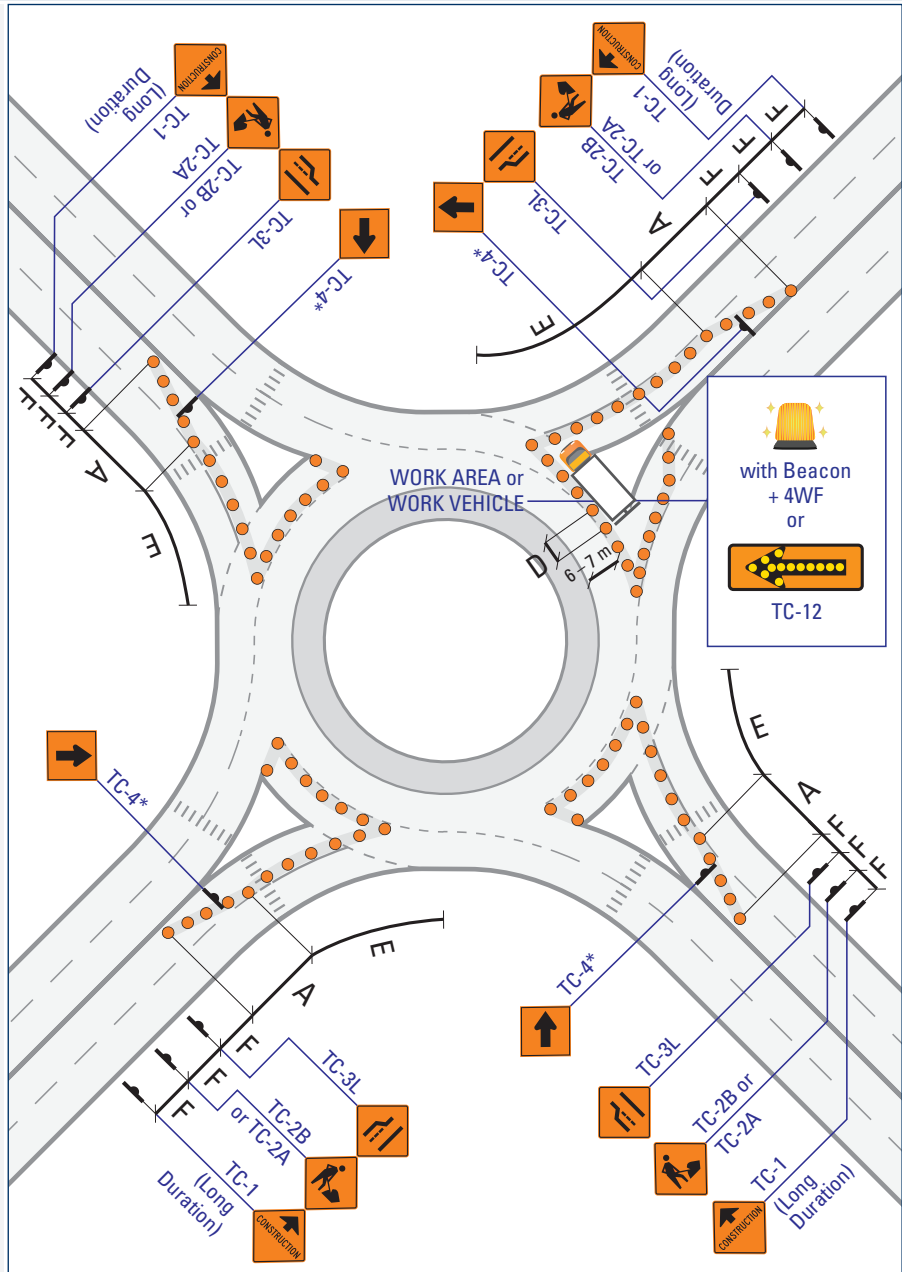

Label	Description	Normal Posted Regulatory Speed (km/h)				
		50	60	70	80	90
<b>A</b>	Taper Length for Full Lane Closure (m)	60	85	155	180	200
<b>D</b>	Maximum Distance between Markers (m)	6	9	9	12	12
	Minimum Number of Markers for Taper	5	7	9	11	13
<b>E</b>	Minimum Tangent between Tapers (m)	60	85	155	180	200
<b>F</b>	Distance between Construction Signs (m)	50	90	120	140	150

**UO-9 Roundabout: One Exit Closed (Detour)**

**Multi-Lane Undivided** Mobile Operations Intermittent Very Short Duration **Short Duration** Long Duration

**NOTES**

- i) See US-25 and US-26 for Detour signing in advance and beyond the Roundabout.
- ii) Any existing signs that contradict or that are duplicated should be covered.

For further detail on Work Zone components, see [Table B \(Short/Long, pg. 241\)](#).

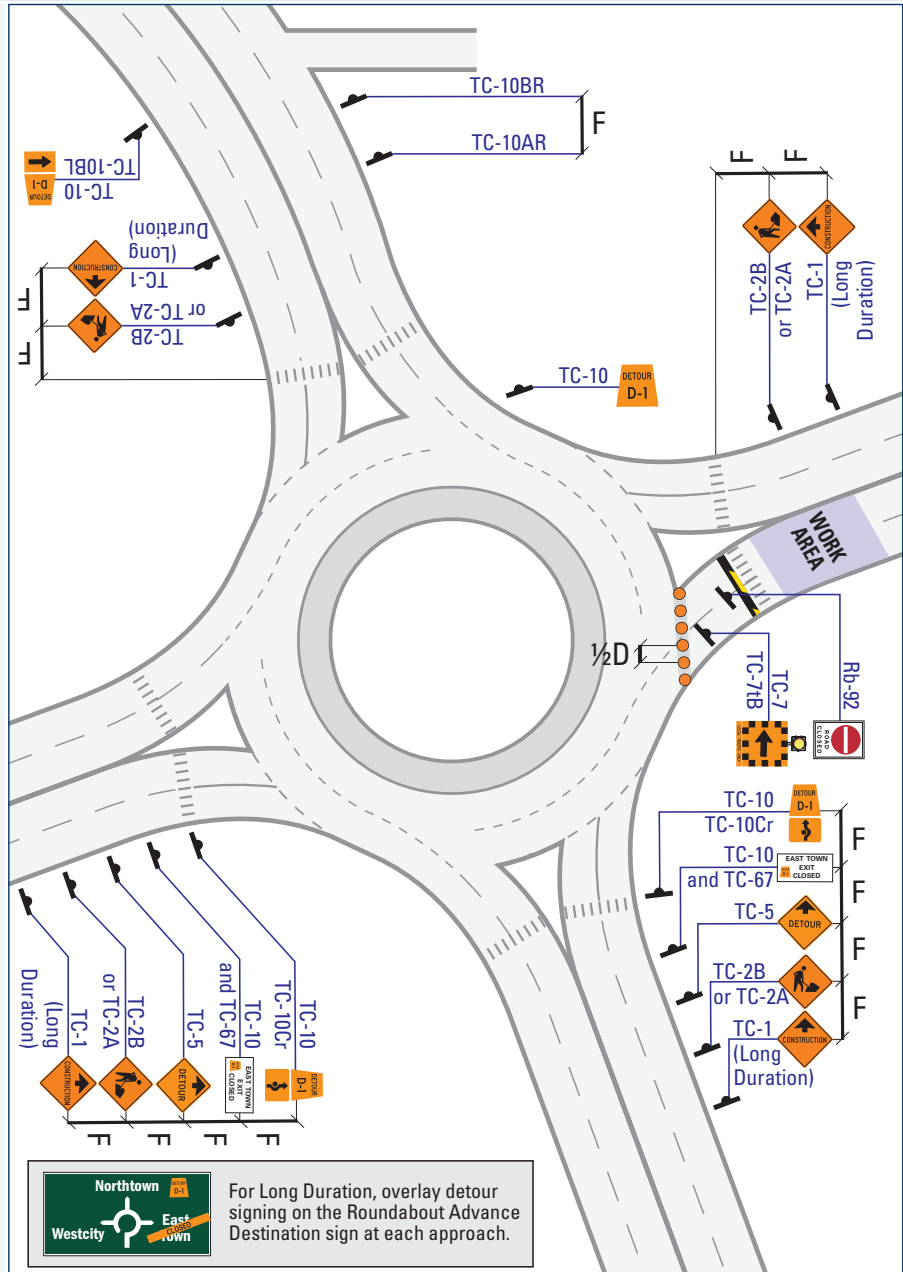

MULTI-LANE UNDIVIDED

Label	Description	Normal Posted Regulatory Speed (km/h)				
		50	60	70	80	90
<b>D</b>	Maximum Distance between Markers (m)	6	9	9	12	12
	Minimum Number of Markers for Taper	5	7	9	11	13
<b>F</b>	Distance between Construction Signs (m)	50	90	120	140	150



**UR-1 Lane Closed at Exit Ramp**

**Multi-Lane Undivided** Mobile Operations Intermittent Very Short Duration Short Duration Long Duration

**NOTES**

i) For Right Lane Closed, see US-17.

ii) In the immediate area of the exit, Marker spacings of half of those shown on Table B should be used.

For further detail on Work Zone components, see [Table B \(Short/Long, pg. 241\)](#).

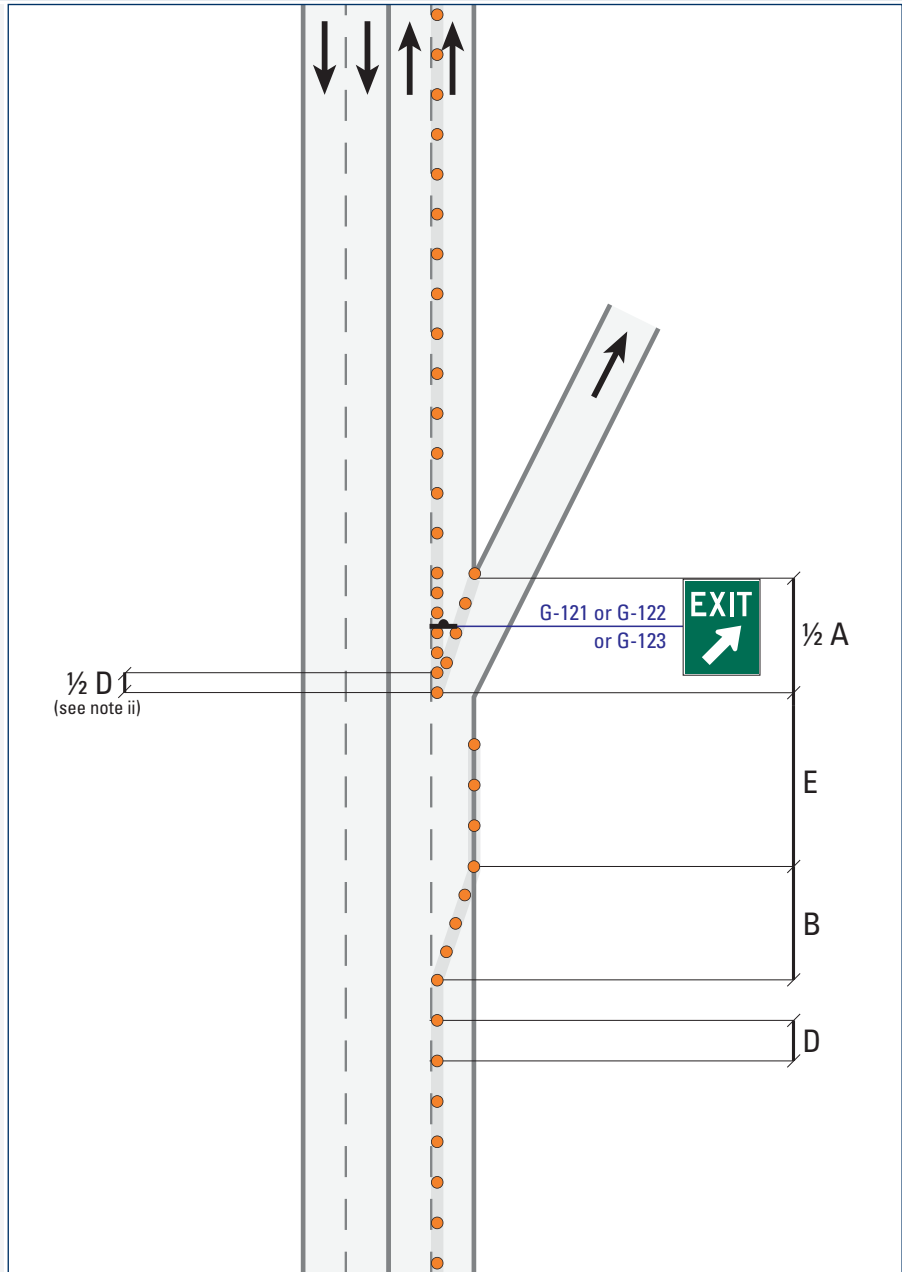

Label	Description	Normal Posted Regulatory Speed (km/h)				
		50	60	70	80	90
<b>A</b>	Taper Length for Full Lane Closure (m)	60	85	155	180	200
<b>B</b>	Shoulder Taper (m)	20	30	55	60	70
<b>D</b>	Maximum Distance between Markers (m)	6	9	9	12	12
	Minimum Number of Markers for Taper	5	7	9	11	13
<b>E</b>	Minimum Tangent between Tapers (m)	60	85	155	180	200

**UR-2 Lane Closed at Exit Ramp with a Deceleration Lane**

**Multi-Lane Undivided** Mobile Operations Intermittent Very Short Duration Short Duration Long Duration

**NOTES**

i) For Right Lane Closed, see US-17.

ii) In the immediate area of the exit, Marker spacings of half of those shown on Table B should be used.

For further detail on Work Zone components, see [Table B \(Short/Long, pg. 241\)](#).

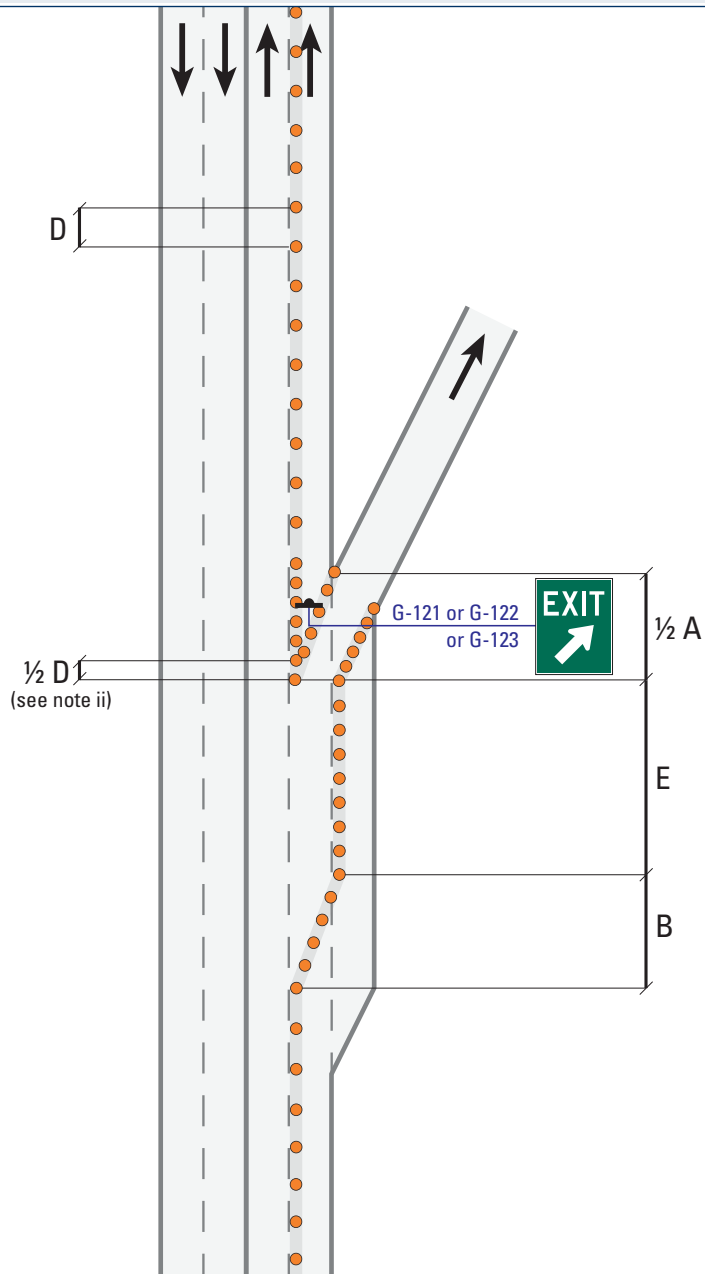

Normal Posted Regulatory Speed (km/h)

Label	Description	50	60	70	80	90
<b>A</b>	Taper Length for Full Lane Closure (m)	60	85	155	180	200
<b>B</b>	Shoulder Taper (m)	20	30	55	60	70
<b>D</b>	Maximum Distance between Markers (m)	6	9	9	12	12
	Minimum Number of Markers for Taper	5	7	9	11	13
<b>E</b>	Minimum Tangent between Tapers (m)	60	85	155	180	200

**UR-3 Lane Closed at Entrance Ramp**

**Multi-Lane Undivided** Mobile Operations Intermittent Very Short Duration **Short Duration** Long Duration

**NOTES**

- i) For Right Lane Closed, see US-17.
- ii) Where space and work activities permit, the acceleration lane should be made as long as possible.
- iii) In the immediate area of the entrance, Marker spacings of half of those shown on Table B should be used.

\*The TC-4 sign must be installed at or just beyond the beginning of a lane closure taper.

For further detail on Work Zone components, see [Table B \(Short/Long, pg. 241\)](#).

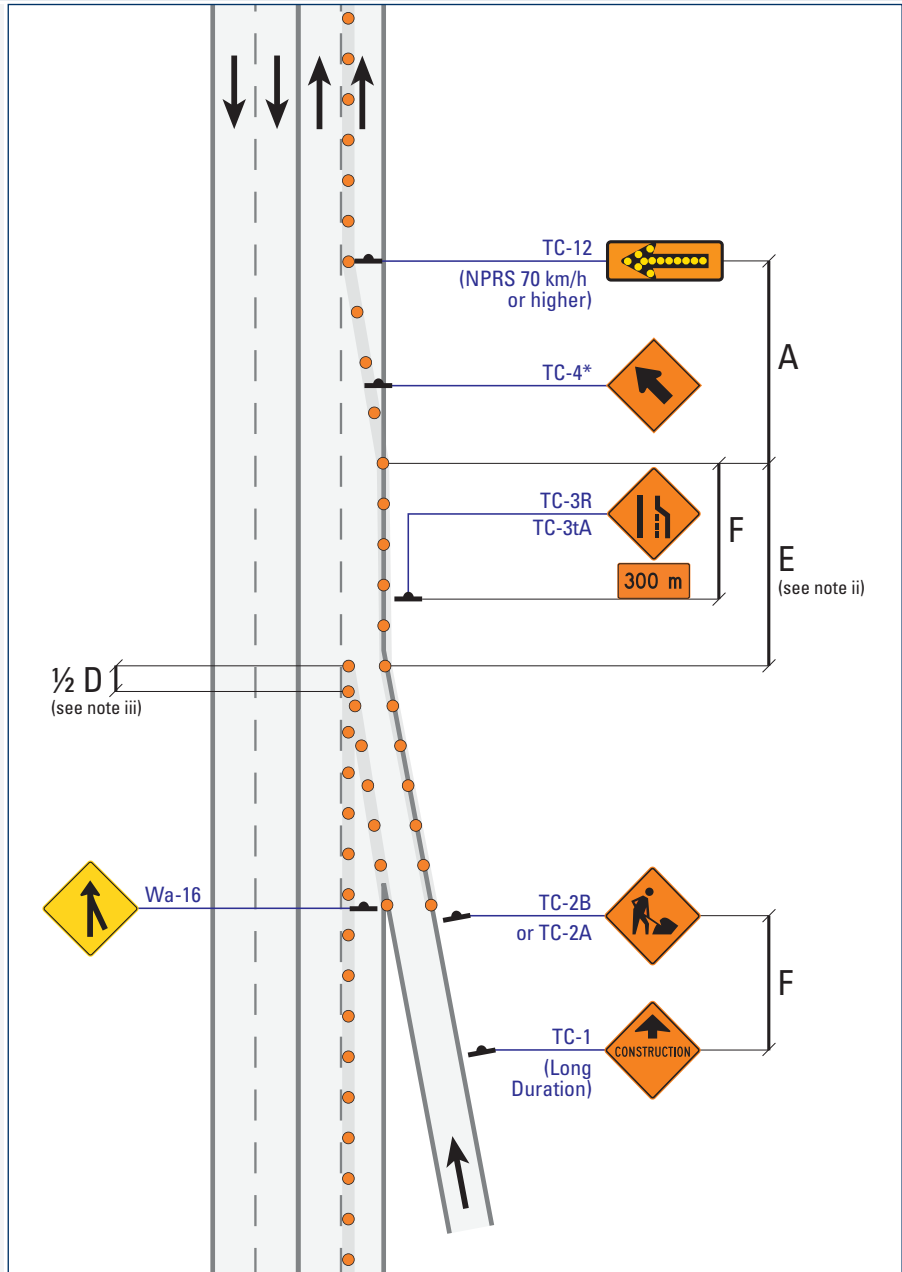

Label	Description	Normal Posted Regulatory Speed (km/h)				
		50	60	70	80	90
<b>A</b>	Taper Length for Full Lane Closure (m)	60	85	155	180	200
<b>D</b>	Maximum Distance between Markers (m)	6	9	9	12	12
	Minimum Number of Markers for Taper	5	7	9	11	13
<b>E</b>	Minimum Tangent between Tapers (m)	60	85	155	180	200
<b>F</b>	Distance between Construction Signs (m)	50	90	120	140	150

**UR-4 Lane Closed at Exit Ramp with an Acceleration Lane**

**Multi-Lane Undivided** Mobile Operations Intermittent Very Short Duration Short Duration Long Duration

**NOTES**

- i) For Right Lane Closed, see US-17.
- ii) Where space and work activities permit, the acceleration lane should be made as long as possible.
- iii) In the immediate area of the entrance, Marker spacings of half of those shown on Table B should be used.

\*The TC-4 sign must be installed at or just beyond the beginning of a lane closure taper.

For further detail on Work Zone components, see [Table B \(Short/Long, pg. 241\)](#).

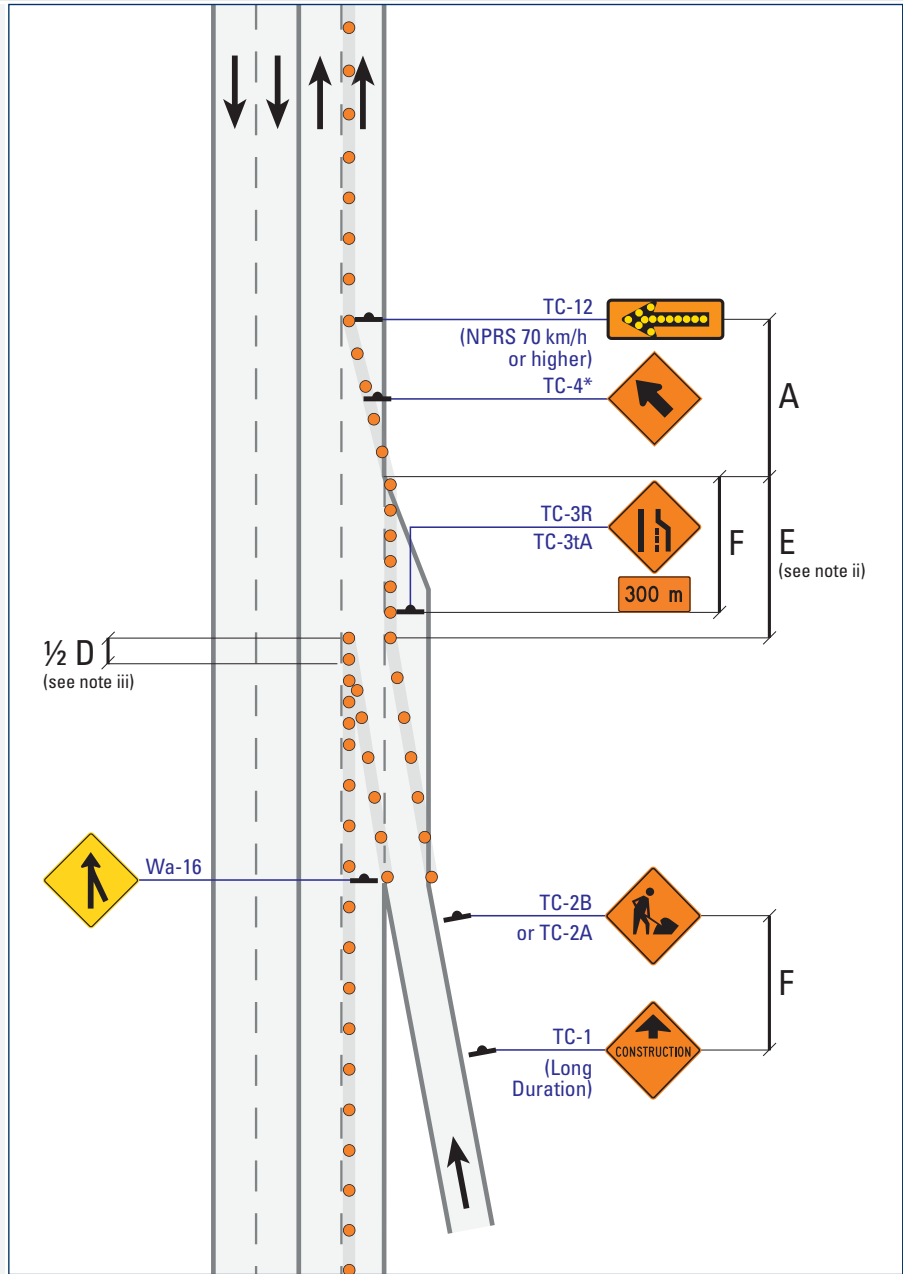

Normal Posted Regulatory Speed (km/h)

Label	Description	50	60	70	80	90
<b>A</b>	Taper Length for Full Lane Closure (m)	60	85	155	180	200
<b>D</b>	Maximum Distance between Markers (m)	6	9	9	12	12
	Minimum Number of Markers for Taper	5	7	9	11	13
<b>E</b>	Minimum Tangent between Tapers (m)	60	85	155	180	200
<b>F</b>	Distance between Construction Signs (m)	50	90	120	140	150

**UR-5**

**Ramp Closed**

**Multi-Lane Undivided**

Mobile Operations

Intermittent

Very Short Duration

**Short Duration**

Long Duration

**NOTES**

i) Closed sign on Directional Guide Signs to be used for Long Duration only. For details, see OTM Book 8.

For further detail on Work Zone components, see [Table B \(Short/Long, pg. 241\)](#).

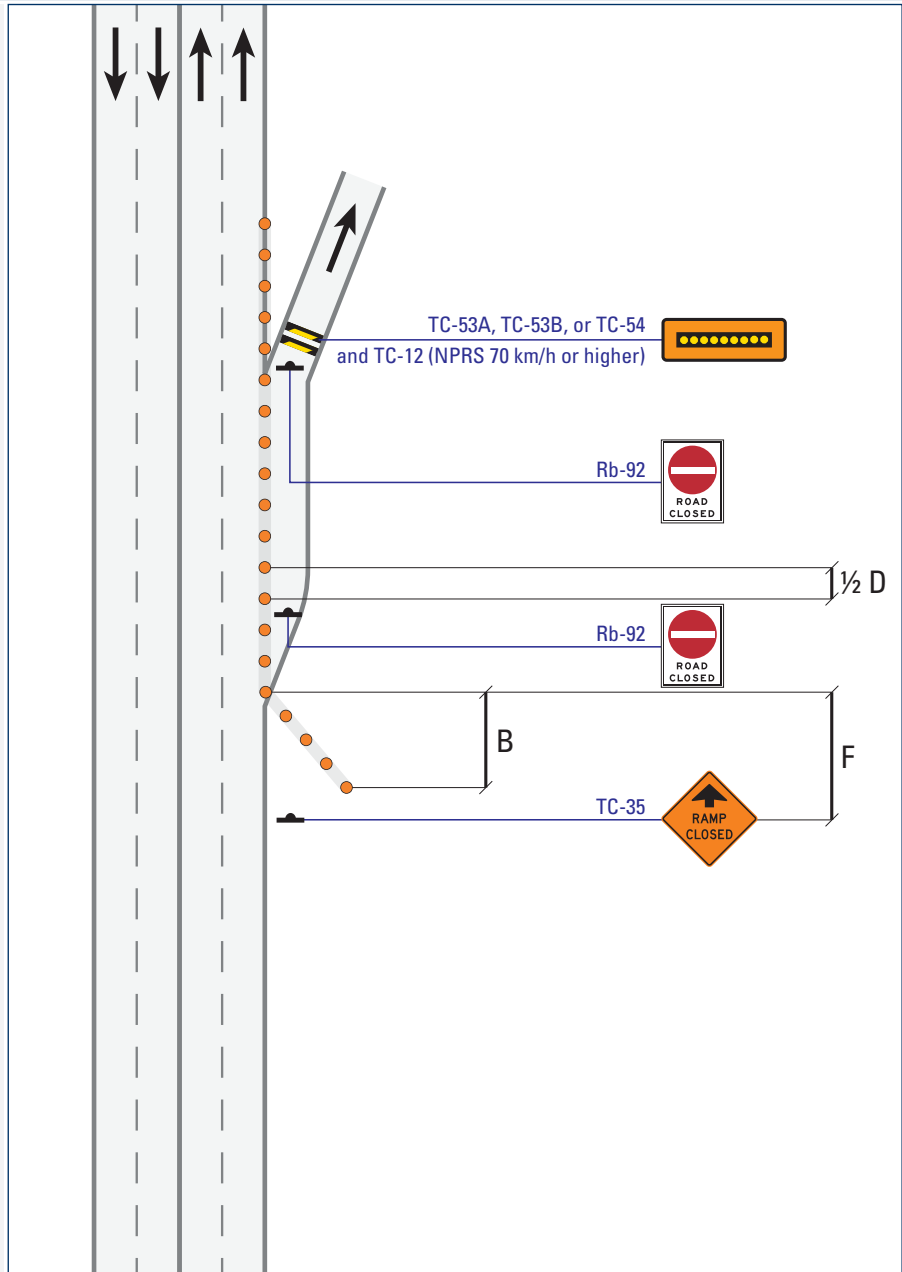

Label	Description	Normal Posted Regulatory Speed (km/h)				
		50	60	70	80	90
<b>B</b>	Shoulder Taper (m)	20	30	55	60	70
<b>D</b>	Maximum Distance between Markers (m)	6	9	9	12	12
	Minimum Number of Markers for Taper	5	7	9	11	13
<b>F</b>	Distance between Construction Signs (m)	50	90	120	140	150

**UR-6 Right Developed Lane Closed**

**Multi-Lane Undivided** Mobile Operations Intermittent Very Short Duration Short Duration Long Duration

**NOTES**

i) Left Developed Lane Closed: mirror image of Right Developed Lane Closed.

For further detail on Work Zone components, see [Table B \(Short/Long, pg. 241\)](#).

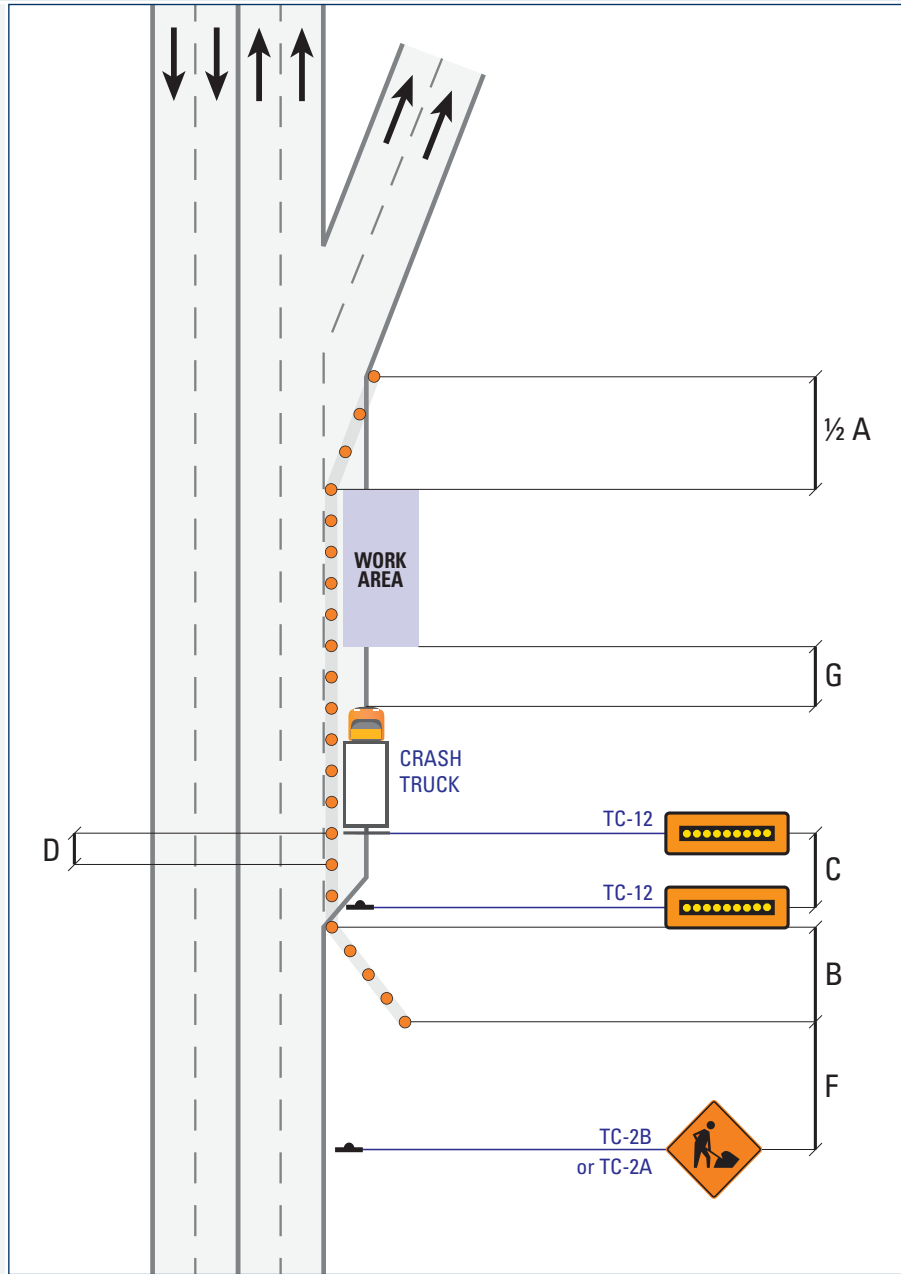

Normal Posted Regulatory Speed (km/h)

Label	Description	50	60	70	80	90
<b>A</b>	Taper Length for Full Lane Closure (m)	60	85	155	180	200
<b>B</b>	Shoulder Taper (m)	20	30	55	60	70
<b>C</b>	Longitudinal Buffer Area (LBA) (m)	(30)	(40)	50	60	75
<b>D</b>	Maximum Distance between Markers (m)	6	9	9	12	12
	Minimum Number of Markers for Taper	5	7	9	11	13
<b>F</b>	Distance between Construction Signs (m)	50	90	120	140	150
<b>G</b>	Stationary Work (Lateral Intrusion Deterrence Gap (LIDG) (m)	(35)	(40)	50	60	65

**DG-1** Designated Construction Zone Signing

Multi-Lane Divided    Mobile Operations    Intermittent    Very Short Duration    Short Duration    Long Duration

**NOTES**

- i) Where signs cannot be accommodated in the median, provide additional signs on the right shoulder or oversize as practicable.
- ii) Recommended, but not required.
- iii) Where required by contract.
- iv) Supplementary layout. This layout shall be used in conjunction with other appropriate layouts. Locations of TC-1, TC-1A, TC-1B shown in DG-1 overrides the locations shown in other layouts when used in conjunction with DG-1.

For further detail on Work Zone components, see [Table B \(Short/Long, pg. 241\)](#).

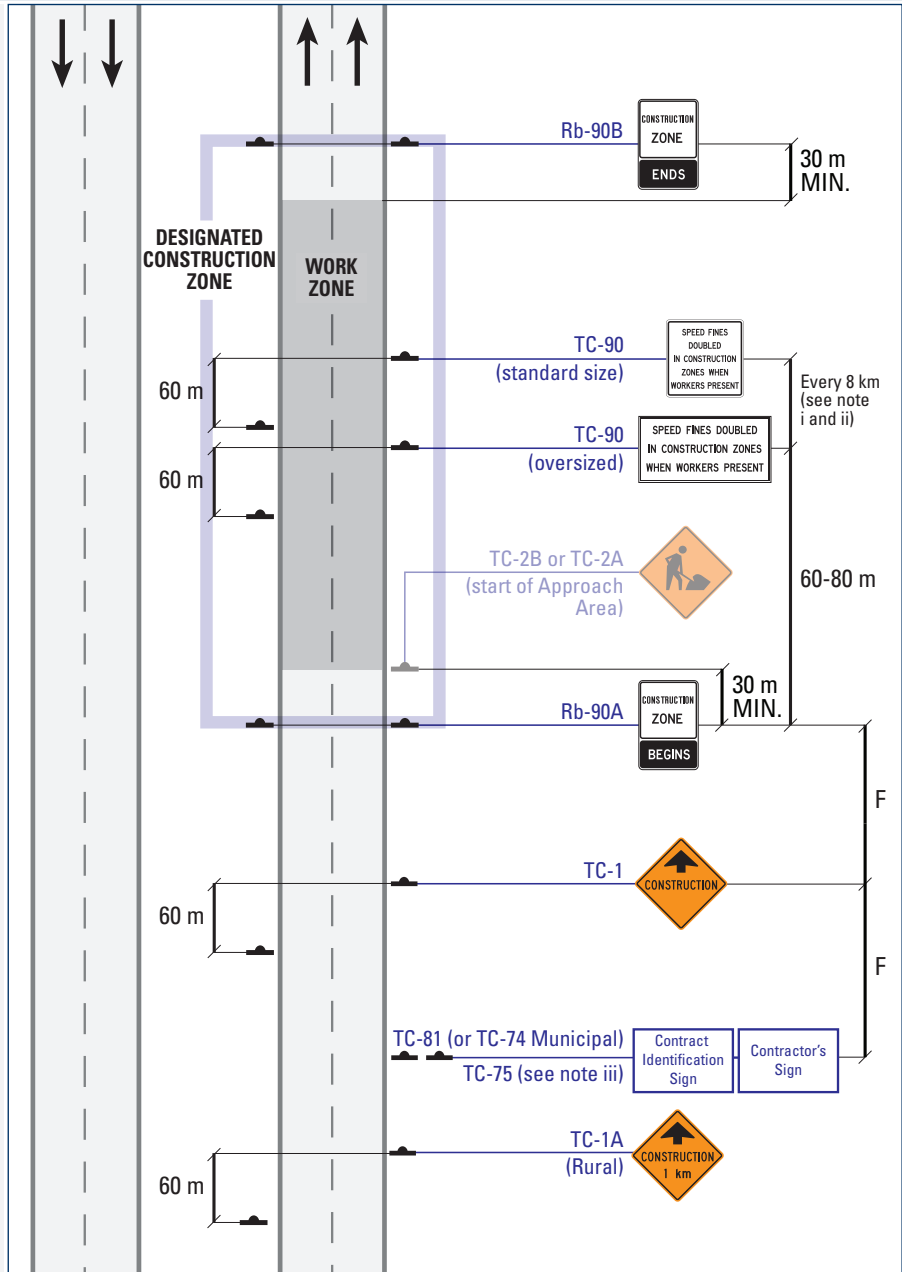

Label	Description	Normal Posted Regulatory Speed (km/h)				
		50	60	70	80	90
<b>F</b>	Distance between Construction Signs (m)	50	90	120	140	150

**DG-2 Reduced Speed Zone Signing**

**Multi-Lane Divided**    Mobile Operations    Intermittent    Very Short Duration    **Short Duration**    Long Duration

**NOTES**

- i) Refer to Regulation 615 of the Highway Traffic Act and OTM Book 5 for distance between regulatory speed limit signs.
- ii) For Regulatory Speed Reduction, a Designated Construction Zone must be established and signed as per DG-1.
- iii) Where signs can be accommodated in the median, provide additional signs on the right shoulder or oversize as practicable.
- iv) Reduced Speed Zone may include all of or only part(s) of the Designated Construction Zone.
- v) Additional signs may be required based on the length of zone.
- vi) Supplementary layout. This layout shall be used in conjunction with other appropriate layouts.

For further detail on Work Zone components, see [Table B \(Short/Long, pg. 241\)](#).

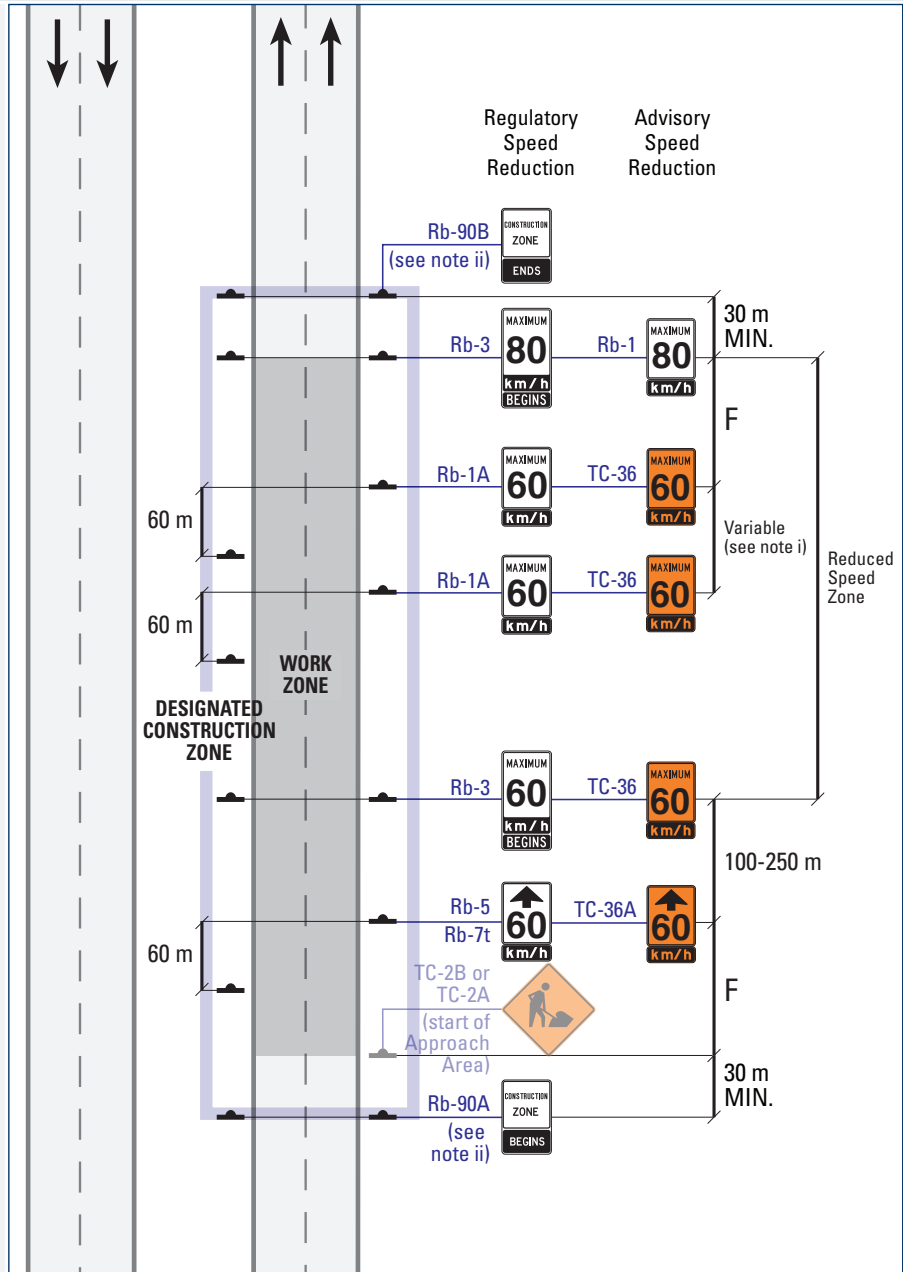

**Normal Posted Regulatory Speed (km/h)**

Label	Description	50	60	70	80	90
<b>F</b>	Distance between Construction Signs (m)	50	90	120	140	150



**DS-1 Intermittent Work**

**Multi-Lane Divided**

Mobile Operations

**Intermittent**

Very Short Duration

Short Duration

Long Duration

**NOTES**

Where a worker is moving within the Intermittent Work Area with only brief stationary moments, for example, pothole patching:

- Worker requires sight distance (refer to H in Table).
- Spotter(s) required when sight distance is not available.
- Where clear and constant verbal communication is not possible (i.e., distance, noise), spotter(s) and worker must use two-way communication devices.
- Where required sight distances (refer to H in Table) are present and the worker/technician's activities permit a continuous consciousness of approaching traffic, a spotter may not be required.
- Worker must not interfere with traffic.

**Note:** this would allow for a single worker operation (i.e., surveyor or possibly one-person pothole repair).

For further detail on Work Zone components, see [Table A \(Mobile/Intermittent/Very Short, pg. 240\)](#).

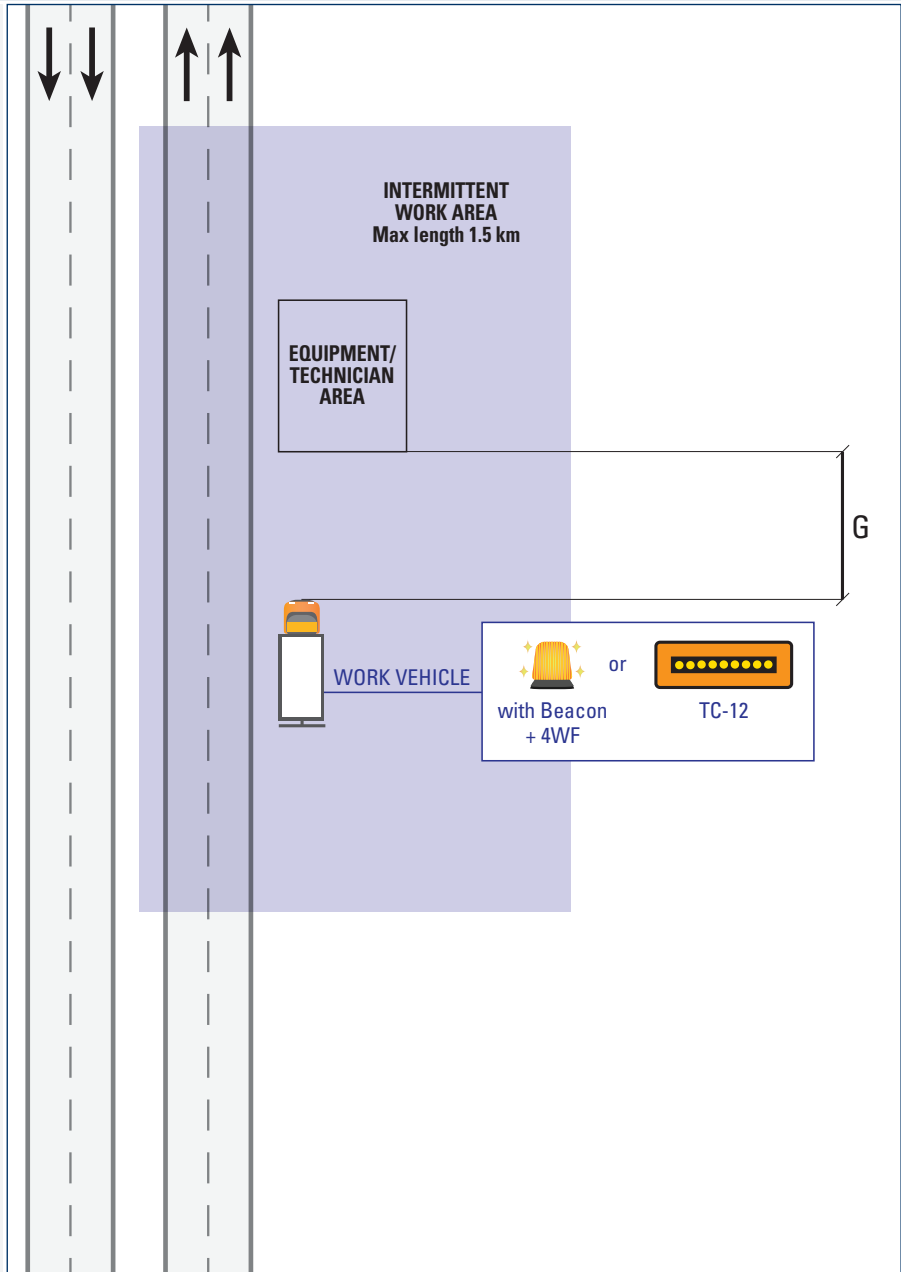

Label	Description	Normal Posted Regulatory Speed (km/h)				
		50	60	70	80	90
<b>G</b>	Stationary Work (Lateral Intrusion Deterrence Gap (LIDG) (m)	(35)	(40)	50	60	65
<b>H</b>	Sight Distance (m)	150	150	200	250	250

**DS-2 Intermittent Work**

Multi-Lane Divided    Mobile Operations    Intermittent    **Very Short Duration**    Short Duration    Long Duration

**NOTES**

i) A Work Vehicle with a TC-12 may replace Markers.

Where a worker is moving within the Intermittent Work Area with only brief stationary moments, for example, debris cleanup:

- Worker requires sight distance (refer to H in Table).
- Spotter(s) required when sight distance is not available.
- Where clear and constant verbal communication is not possible (i.e., distance, noise), spotter(s) and worker must use two-way communication devices.
- Where required sight distances (refer to H in Table) are present and the worker/technician's activities permit a continuous consciousness of approaching traffic, a spotter may not be required.
- Worker must not interfere with traffic.

Note: this would allow for a single worker operation (i.e., surveyor or possibly one-person pothole repair).

For further detail on Work Zone components, see Table A (Mobile/Intermittent/Very Short, pg. 240).

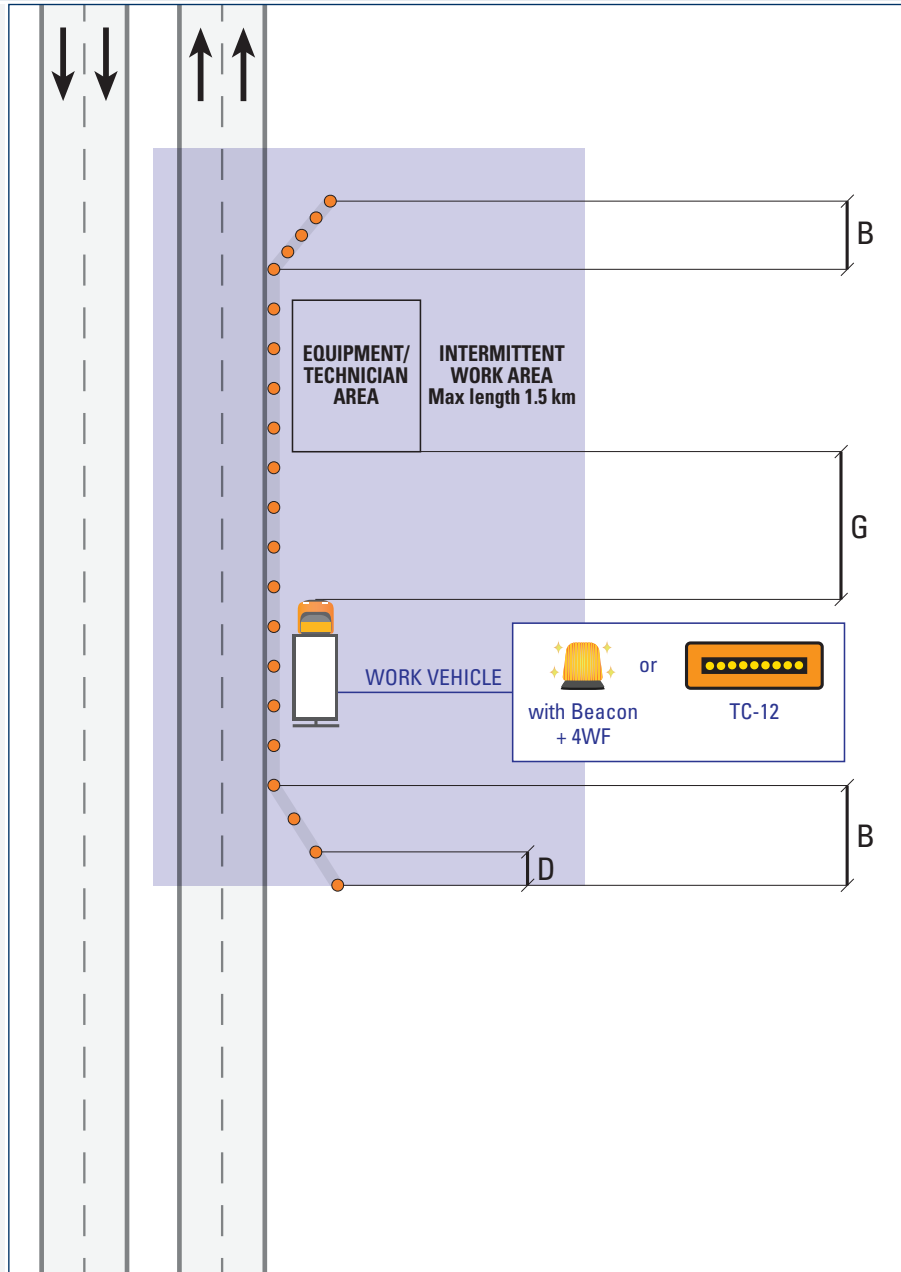

Normal Posted Regulatory Speed (km/h)

Label	Description	Normal Posted Regulatory Speed (km/h)				
		50	60	70	80	90
<b>B</b>	Shoulder Taper (m)	20	30	35	35	40
<b>D</b>	Maximum Distance between Markers (m)	6	6	9	9	12
	Minimum Number of Markers for Taper	4	5	5	7	8
<b>G</b>	Stationary Work (Lateral Intrusion Deterrence Gap (LIDG) (m)	(35)	(40)	50	60	65
<b>H</b>	Sight Distance (m)	150	150	200	250	250

**DS-3 Intermittent Work**

**Multi-Lane Divided**    Mobile Operations    Intermittent    Very Short Duration    **Short Duration**    Long Duration

**NOTES**

i) A Work Vehicle with a TC-12 may replace Markers.

Where a worker is moving within the Intermittent Work Area with only brief stationary moments, for example, surveying:

- Worker requires sight distance (refer to H in Table).
- Spotter(s) required when sight distance is not available.
- Where clear and constant verbal communication is not possible (i.e., distance, noise), spotter(s) and worker must use two-way communication devices.
- Where required sight distances (refer to H in Table) are present and the worker/technician's activities permit a continuous consciousness of approaching traffic, a spotter may not be required.
- Worker must not interfere with traffic.

Note: this would allow for a single worker operation (i.e., surveyor or possibly one-person pothole repair).

For further detail on Work Zone components, see [Table B \(Short/Long, pg. 241\)](#).

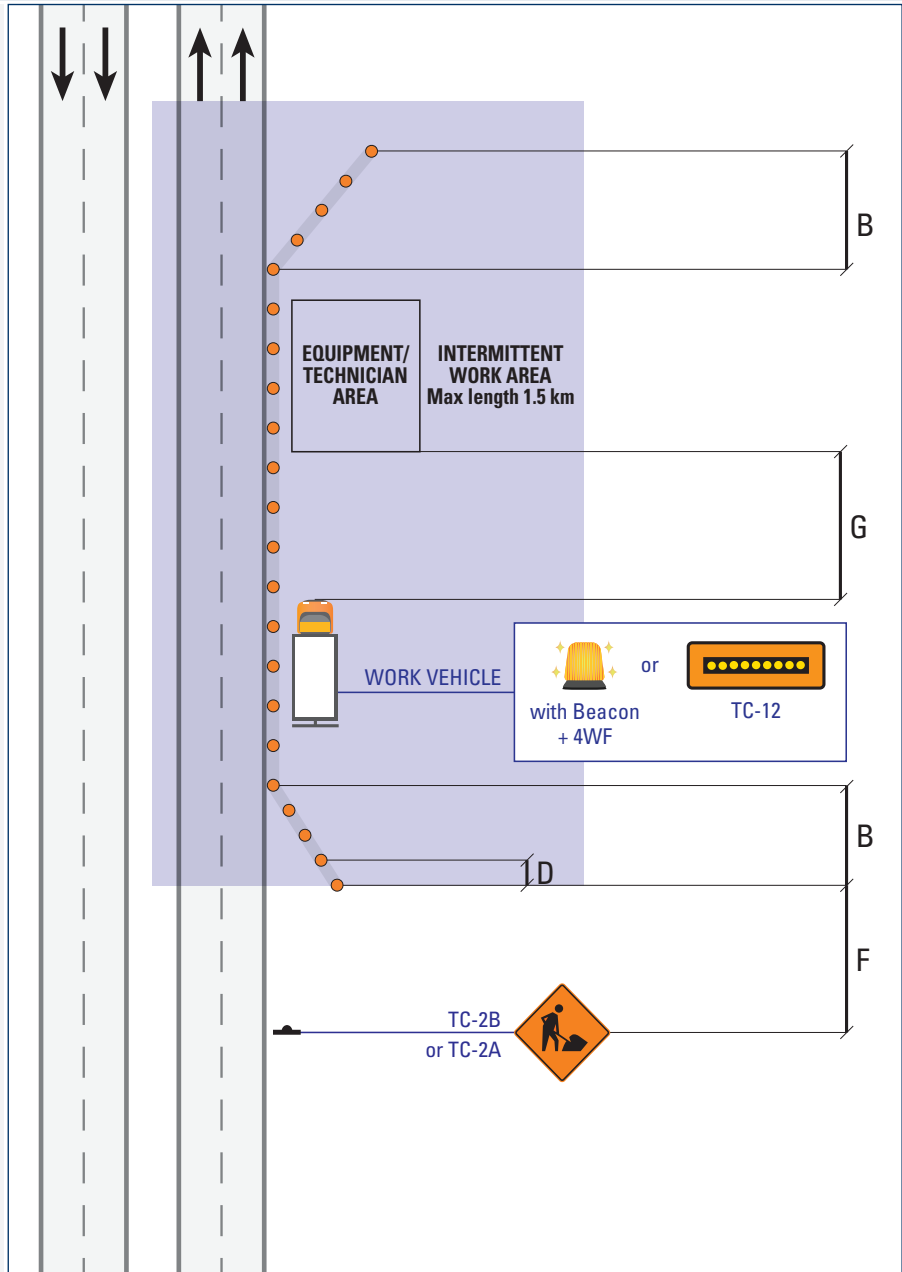

Label	Description	Normal Posted Regulatory Speed (km/h)				
		50	60	70	80	90
<b>B</b>	Shoulder Taper (m)	20	30	55	60	70
<b>D</b>	Maximum Distance between Markers (m)	6	9	9	12	12
	Minimum Number of Markers for Taper	5	7	9	11	13
<b>F</b>	Distance between Construction Signs (m)	50	90	120	140	150
<b>G</b>	Stationary Work (Lateral Intrusion Deterrence Gap (LIDG) (m)	(35)	(40)	50	60	65
<b>H</b>	Sight Distance (m)	150	150	200	250	250

**DS-4**

**Shoulder Work**

**Multi-Lane Divided**

**Mobile Operations**

**Intermittent**

**Very Short Duration**

Short Duration

Long Duration

**NOTES**

- i) Mirror image for work on the left shoulder.
- ii) Termination Taper optional.
- iii) When a vehicle on shoulder with TC-12 enters a live lane, the TC-12 in bar mode must be switched to arrow mode.

For further detail on Work Zone components, see [Table A \(Mobile/Intermittent/Very Short, pg. 240\)](#).

**With Work Vehicle - Mobile, Intermittent, or VSD**

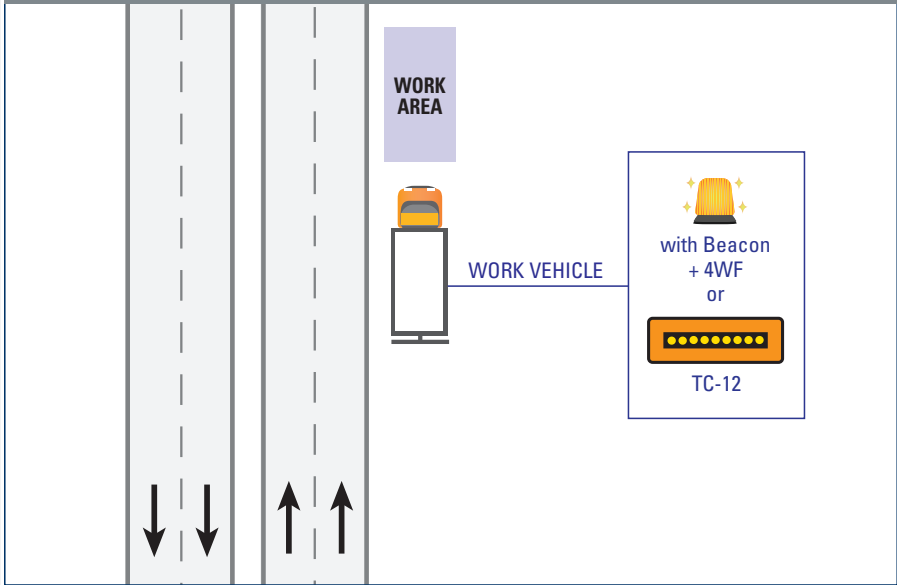

**Without Work Vehicle – VSD**

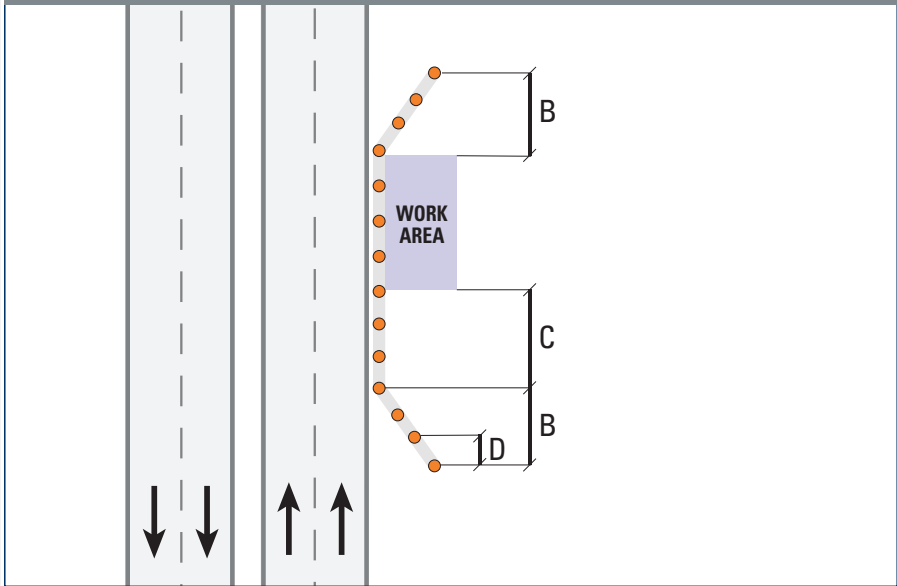

Label	Description	Normal Posted Regulatory Speed (km/h)				
		50	60	70	80	90
<b>B</b>	Shoulder Taper (m)	20	30	35	35	40
<b>C</b>	Longitudinal Buffer Area (LBA) (m)	(30)	(40)	50	60	75
<b>D</b>	Maximum Distance between Markers (m)	6	6	9	9	12
Minimum Number of Markers for Taper		4	5	5	7	8

**DS-5 Shoulder Work**

**Multi-Lane Divided**

Mobile Operations

Intermittent

Very Short Duration

**Short Duration**

Long Duration

**NOTES**

- i) Mirror image for work on the left shoulder.
- ii) Termination Taper optional.
- iii) Work Area may or may not contain a Work Vehicle. See General Notes to Layouts #4.
- iv) A Work Vehicle with a TC-12 may replace Markers for Short Duration work.

For further detail on Work Zone components, see [Table B \(Short/Long, pg. 241\)](#).

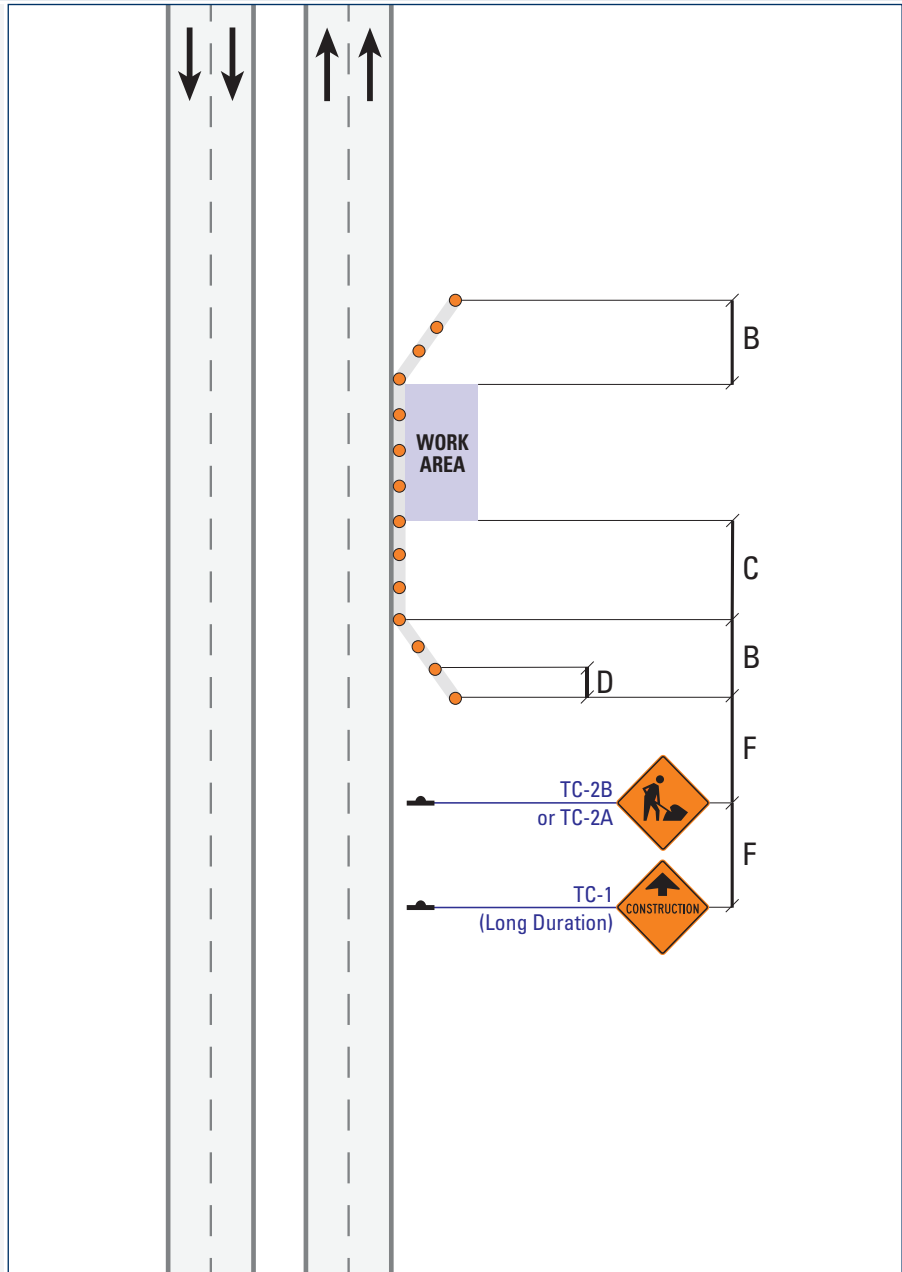

Label	Description	Normal Posted Regulatory Speed (km/h)				
		50	60	70	80	90
<b>B</b>	Shoulder Taper (m)	20	30	55	60	70
<b>C</b>	Longitudinal Buffer Area (LBA) (m)	(30)	(40)	50	60	75
<b>D</b>	Maximum Distance between Markers (m)	6	9	9	12	12
	Minimum Number of Markers for Taper	5	7	9	11	13
<b>F</b>	Distance between Construction Signs (m)	50	90	120	140	150

**DS-6 Lane Encroachment**

**Multi-Lane Divided**    **Mobile Operations**    **Intermittent**    **Very Short Duration**    Short Duration    Long Duration

**NOTES**

- i) Termination Taper optional.
- ii) Encroachment in the left lane: mirror image of right lane.
- iii) In addition to the minimum requirement of 3 m temporary lane width, an offset of 0.3 m to 0.6 m between Markers and the edge of the traveled lane is desirable.

For further detail on Work Zone components, see [Table A \(Mobile/Intermittent/Very Short, pg. 240\)](#).

**With Work Vehicle - Mobile, Intermittent, or VSD**

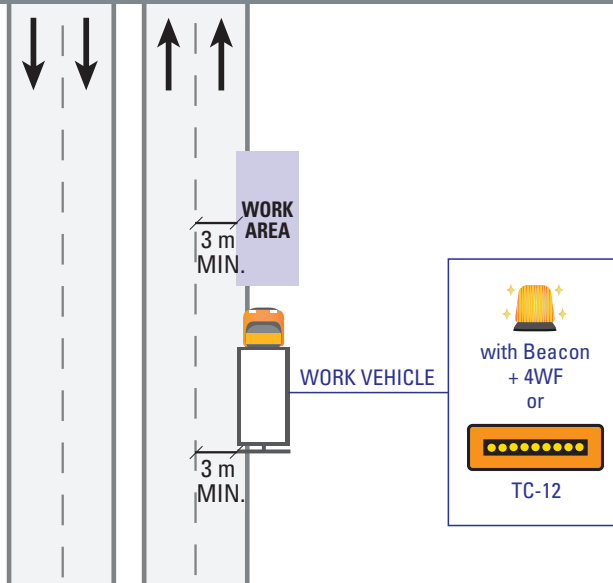

**Without Work Vehicle – VSD**

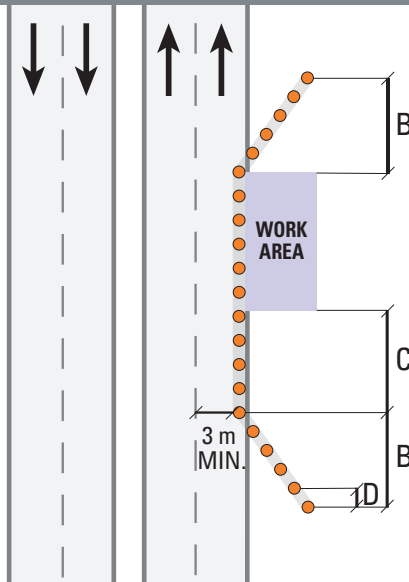

Label	Description	Normal Posted Regulatory Speed (km/h)				
		50	60	70	80	90
<b>B</b>	Shoulder Taper (m)	20	30	35	35	40
<b>C</b>	Longitudinal Buffer Area (LBA) (m)	(30)	(40)	50	60	75
<b>D</b>	Maximum Distance between Markers (m)	6	6	9	9	12
Minimum Number of Markers for Taper		4	5	5	7	8

**DS-7 Lane Encroachment**

**Multi-Lane Divided**    Mobile Operations    Intermittent    Very Short Duration    **Short Duration**    Long Duration

**NOTES**

- i) Encroachment in the left lane: mirror image of right lane.
- ii) Work Area may or may not contain a Work Vehicle. See General Notes to Layouts #4.
- iii) A Work Vehicle with a TC-12 may replace Markers for Short Duration work where NPRS is 60 km/h or lower.
- iv) In addition to the minimum requirement of 3 m temporary lane width, an offset of 0.3 m to 0.6 m between Markers and the edge of the traveled lane is desirable.

For further detail on Work Zone components, see [Table B \(Short/Long, pg. 241\)](#).

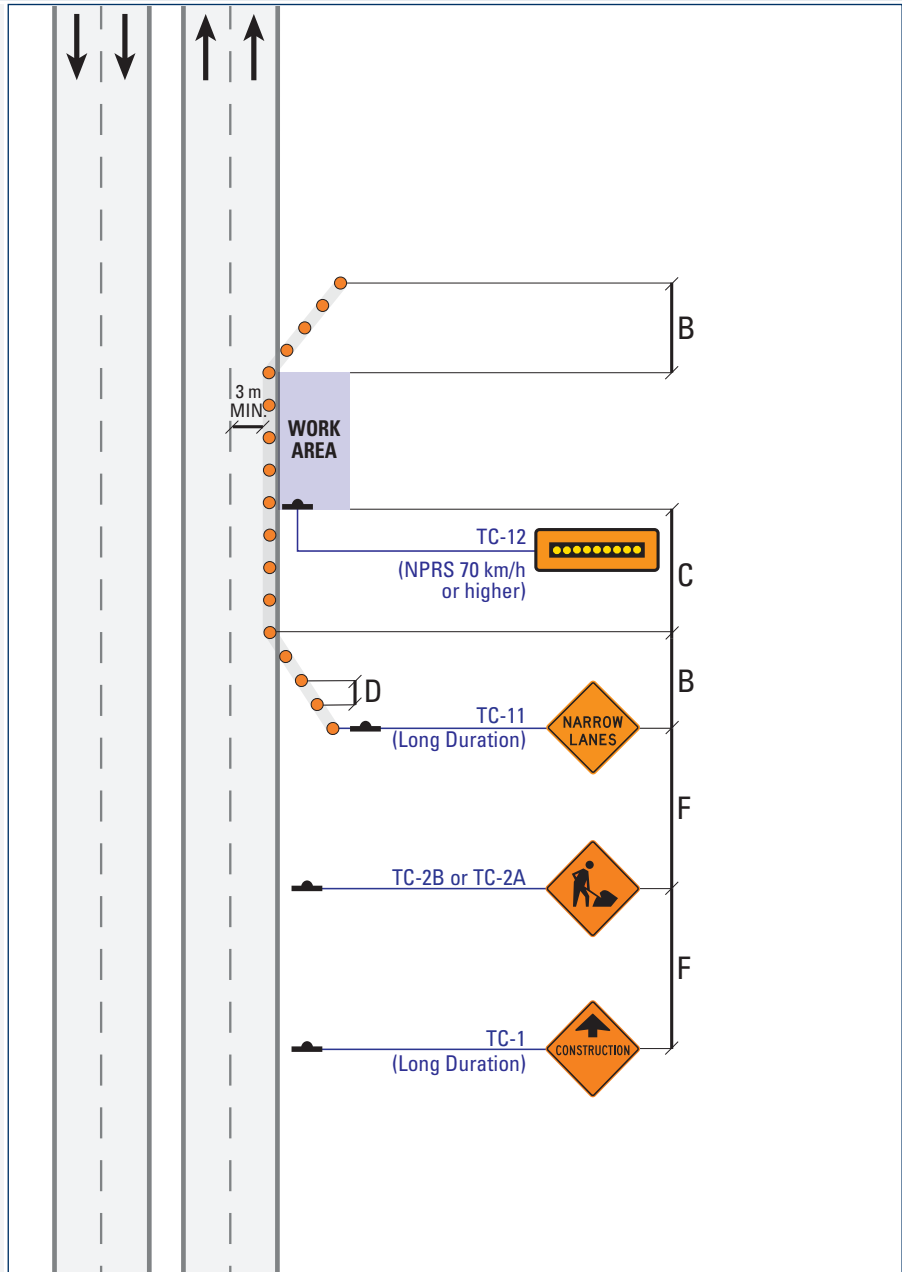

Label	Description	Normal Posted Regulatory Speed (km/h)				
		50	60	70	80	90
<b>B</b>	Shoulder Taper (m)	20	30	55	60	70
<b>C</b>	Longitudinal Buffer Area (LBA) (m)	(30)	(40)	50	60	75
<b>D</b>	Maximum Distance between Markers (m)	6	9	9	12	12
	Minimum Number of Markers for Taper	5	7	9	11	13
<b>F</b>	Distance between Construction Signs (m)	50	90	120	140	150

**DS-8** **Parking Lane Closed**

**Multi-Lane Divided**    Mobile Operations    Intermittent    **Very Short Duration**    Short Duration    Long Duration

**NOTES**

i) A Work Vehicle with Beacon + 4WF or a TC-12 in bar mode can replace Markers.

For further detail on Work Zone components, see [Table A \(Mobile/Intermittent/Very Short, pg. 240\)](#).

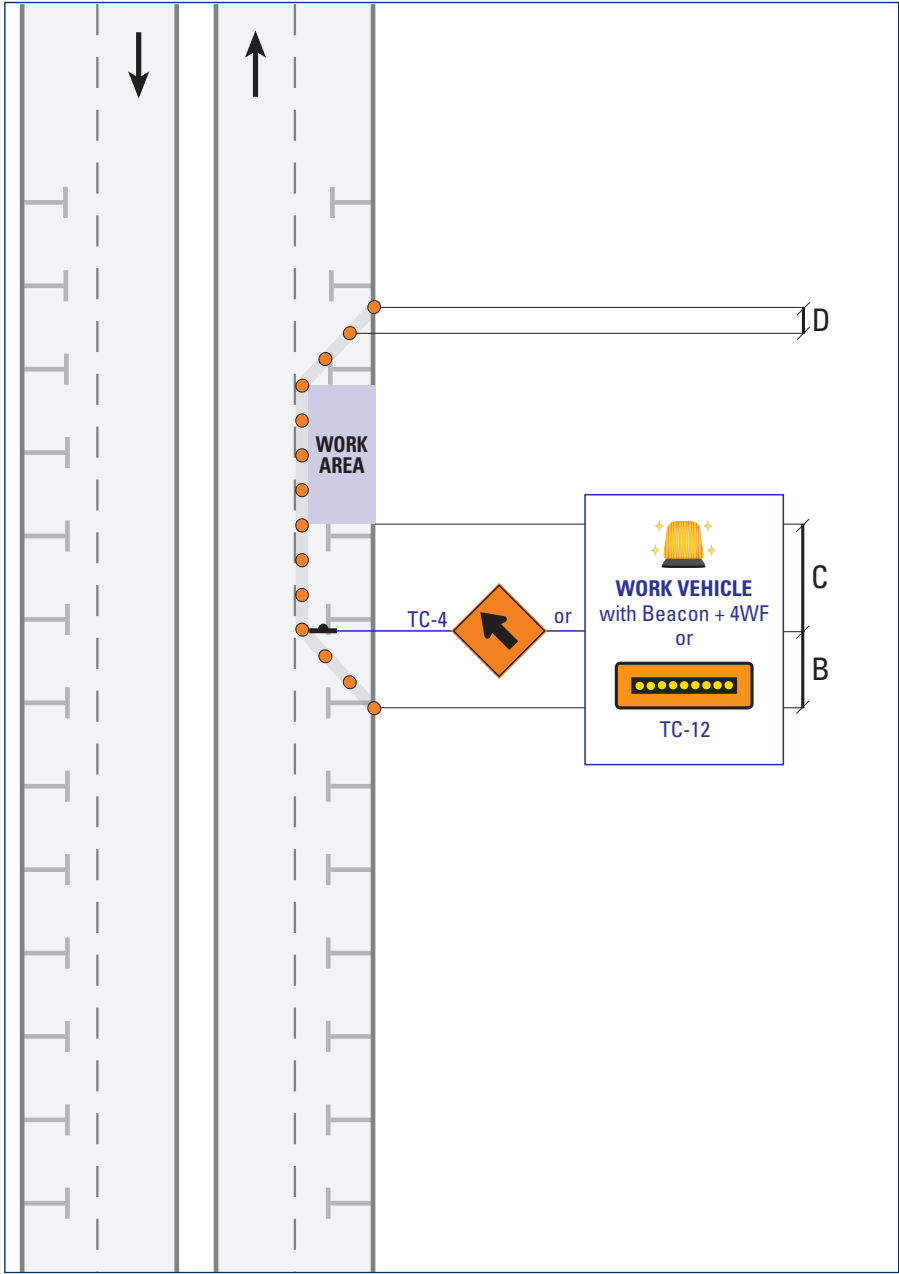

Label	Description	Normal Posted Regulatory Speed (km/h)			
		50	60	70	80
<b>B</b>	Shoulder Taper (m)	20	30	35	35
<b>C</b>	Longitudinal Buffer Area (LBA) (m)	(30)	(40)	50	60
<b>D</b>	Maximum Distance between Markers (m)	6	6	9	9
	Minimum Number of Markers for Taper	4	5	5	7

MULTI-LANE DIVIDED



**DS-9** **Parking Lane Closed**

**Multi-Lane Divided**    Mobile Operations    Intermittent    Very Short Duration    **Short Duration**    Long Duration

**NOTES**

- i) Placement of TC-1 or TC-2 may need to be adjusted if visibility is obstructed due to parked vehicles.
- ii) For Short Duration work, a Work Vehicle with Beacon + 4WF or a TC-12 in bar mode can replace Markers.

For further detail on Work Zone components, see [Table B \(Short/Long, pg. 241\)](#).

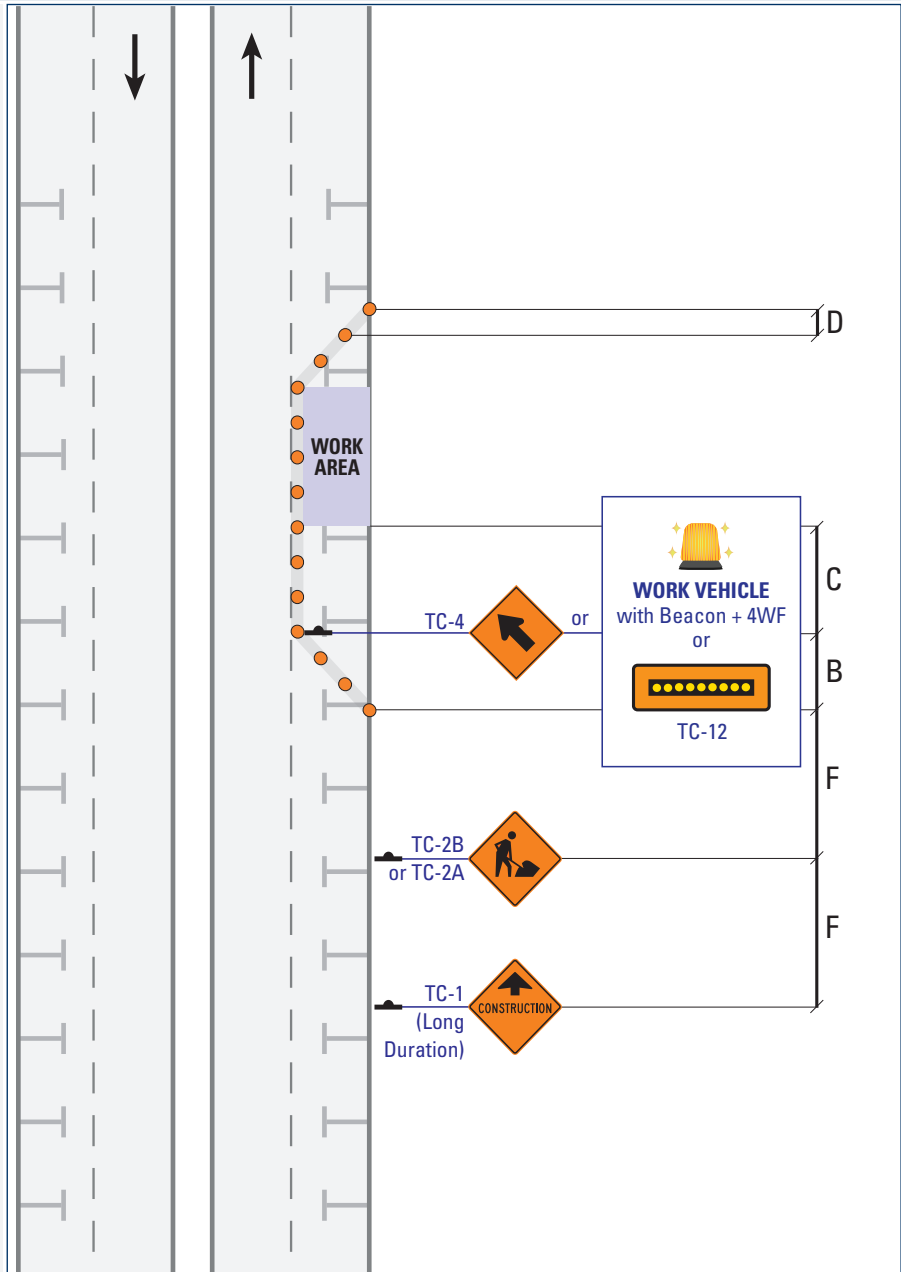

Label	Description	Normal Posted Regulatory Speed (km/h)			
		50	60	70	80
<b>B</b>	Shoulder Taper (m)	20	30	55	60
<b>C</b>	Longitudinal Buffer Area (LBA) (m)	(30)	(40)	50	60
<b>D</b>	Maximum Distance between Markers (m)	6	9	9	12
	Minimum Number of Markers for Taper	5	7	9	11
<b>F</b>	Distance between Construction Signs (m)	50	90	120	140

**DS-10 Partial Lane Shift: Narrow Lanes**

**Multi-Lane Divided**    Mobile Operations    Intermittent    Very Short Duration    Short Duration    Long Duration

**NOTES**

i) Minimum lane width is 3 m. Additionally, an offset of 0.3 m to 0.6 m between Markers and the edge of the traveled lane is desirable.

ii) For narrowed lanes exceeding 2 km, use a TC-16 EL (ER) in place of the TC-9L (R). Add an additional TC-16 ER (EL) at the beginning of end Taper.

For further detail on Work Zone components, see [Table B \(Short/Long, pg. 241\)](#).

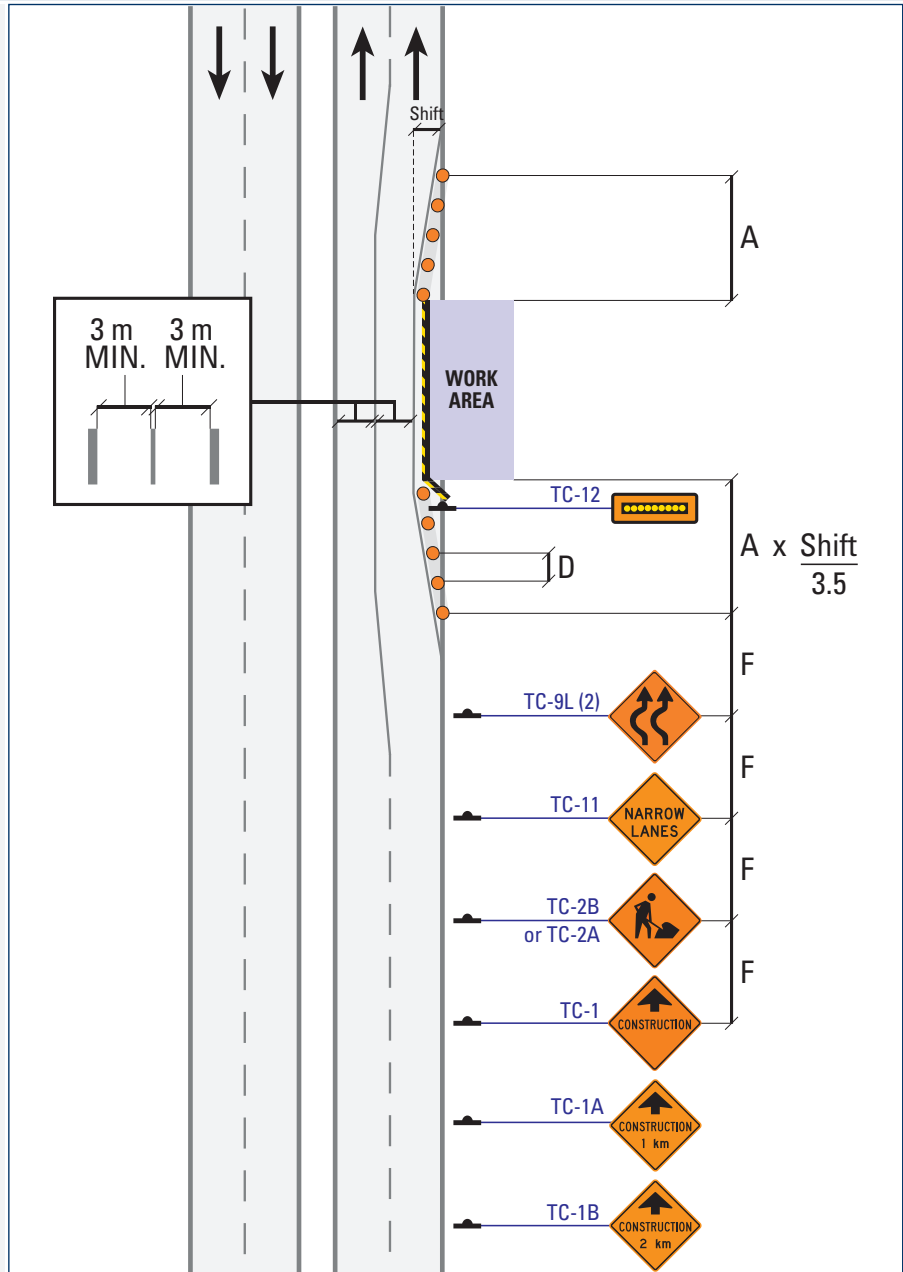

Normal Posted Regulatory Speed (km/h)

Label	Description	50	60	70	80	90
<b>A</b>	Taper Length for Full Lane Closure (m)	60	85	155	180	200
<b>D</b>	Maximum Distance between Markers (m)	6	9	9	12	12
	Minimum Number of Markers for Taper	5	7	9	11	13
<b>F</b>	Distance between Construction Signs (m)	50	90	120	140	150

**DS-11 Lane Realignment**

**Multi-Lane Divided**    Mobile Operations    Intermittent    Very Short Duration    Short Duration    Long Duration

**NOTES**

- i) Refer to OTM Book 6 for the appropriate placement of TC-18L.
- ii) Markers used for additional Delineation through Tangent on the far-side of the Work Area are optional.
- iii) If the space in median is not sufficient, then US-11 should be used.
- iv) Work on the right shoulder: mirror image.

For further detail on Work Zone components, see [Table B \(Short/Long, pg. 241\)](#).

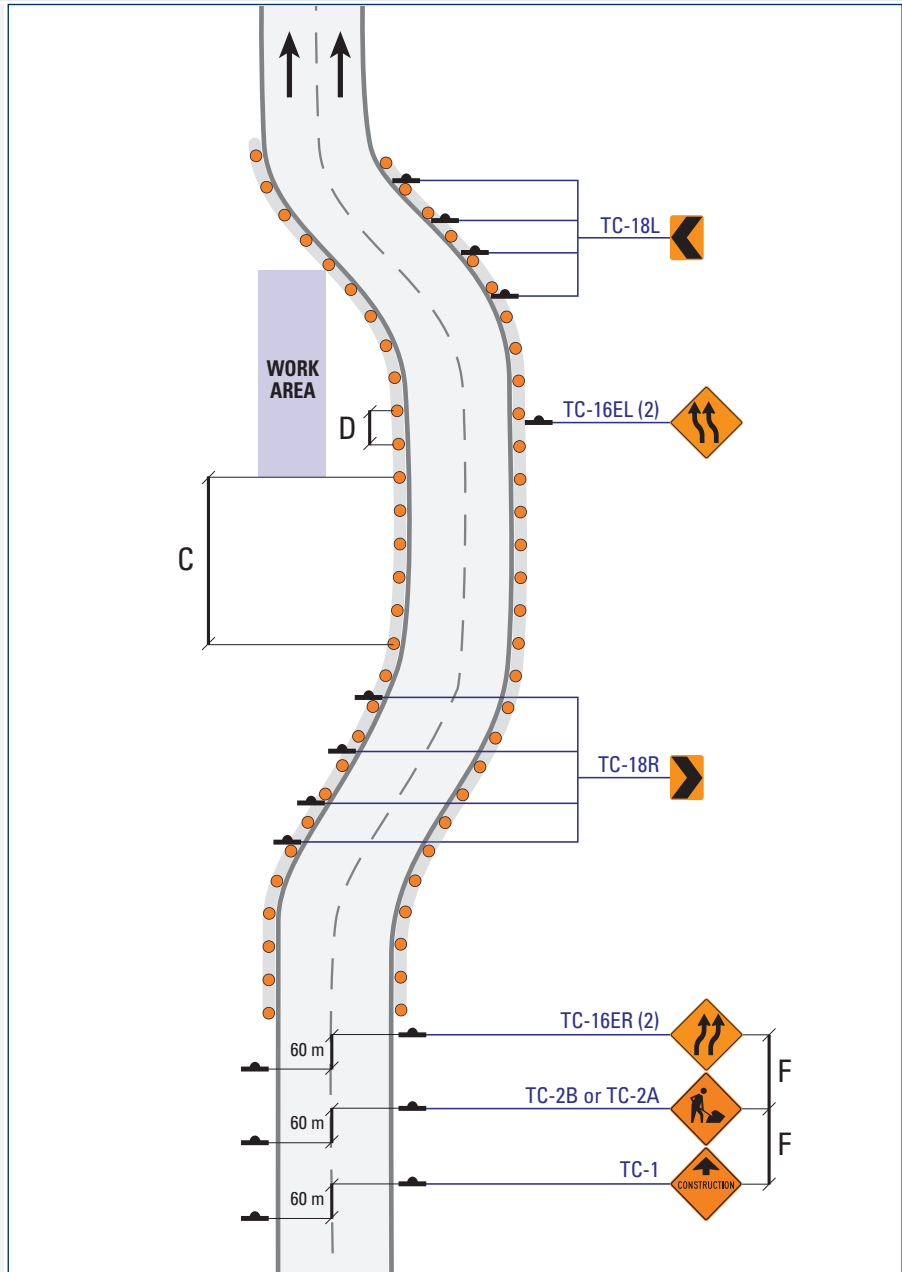

Label	Description	Normal Posted Regulatory Speed (km/h)				
		50	60	70	80	90
<b>C</b>	Longitudinal Buffer Area (LBA) (m)	(30)	(40)	50	60	75
<b>D</b>	Maximum Distance between Markers (m)	6	9	9	12	12
	Minimum Number of Markers for Taper	5	7	9	11	13
<b>F</b>	Distance between Construction Signs (m)	50	90	120	140	150

**DS-12 Zone Painting: Right or Left Lane Closed**

**Multi-Lane Divided**    **Mobile Operations**    Intermittent    Very Short Duration    Short Duration    Long Duration

**NOTES**

- i) MTO requirements illustrated. Other Road Authorities may not require a "ROAD PAINTING" information sign.
- ii) Sign Truck may be replaced by an approved equivalent VMS.
- iii) Where shoulder is intermittent, Sign Truck should drive with traffic flow in arrow mode until shoulder becomes available.
- iv) Left Lane Closed mirror image where the Sign Truck should follow on the same side shoulder as the closure.
- v) The distance between Sign Truck and Buffer Vehicle may be adjusted to accommodate hills, curves, restricted visibility, or other specific conditions.

For further detail on Work Zone components, see [Table A \(Mobile/Intermittent/Very Short, pg. 240\)](#).

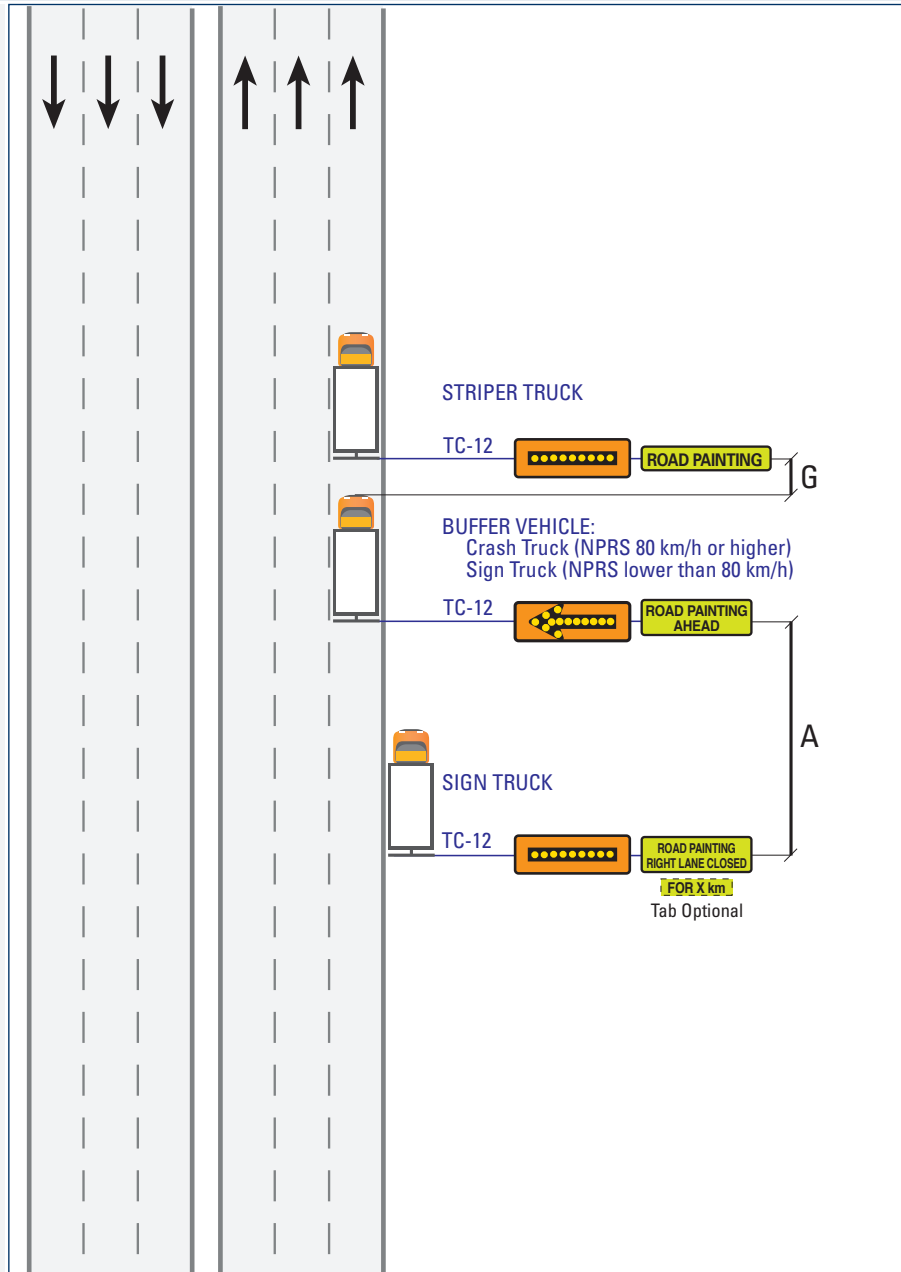

**Normal Posted Regulatory Speed (km/h)**

Label	Description	50	60	70	80	90
<b>A</b>	Taper Length for Full Lane Closure (m)	60	85	100	100	110
<b>G</b>	Mobile Work: Lateral Intrusion Deterrence Gap (LIDG) (m)	–	–	35	45	50

**DS-13**

**Lane Closed or Occupied**

**Multi-Lane Divided**

**Mobile Operations**

**Intermittent**

**Very Short Duration**

Short Duration

Long Duration

**NOTES**

i) Distance between Sign Truck and Work Vehicle may be adjusted to accommodate hills, curves, restricted visibility, or other site specific conditions.

ii) Where shoulder is intermittent, Sign Truck should drive with traffic flow until shoulder becomes available.

iii) Left Lane Closed: mirror image.

For further detail on Work Zone components, see [Table A \(Mobile/Intermittent/Very Short, pg. 240\)](#).

**With Work Vehicle – Mobile, Intermittent, or VSD**

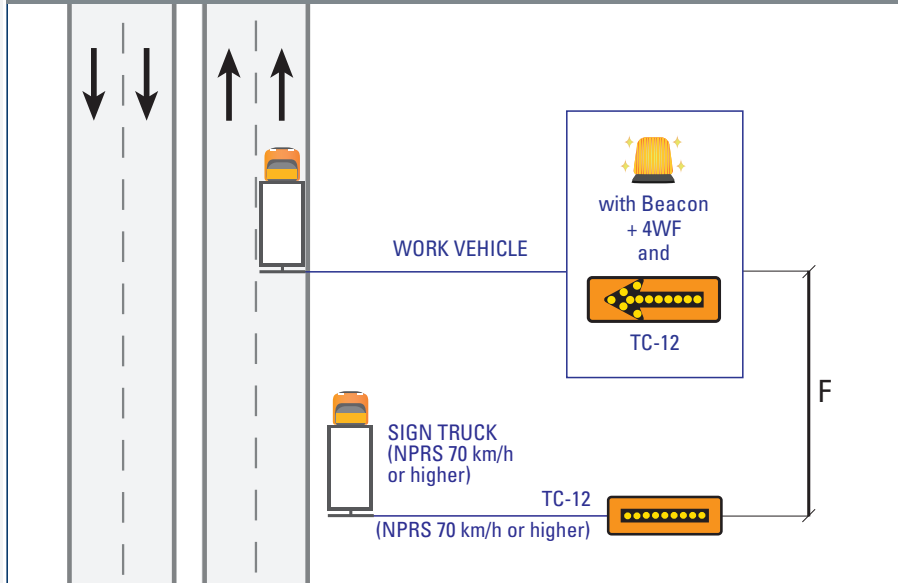

**Without Work Vehicle – VSD**

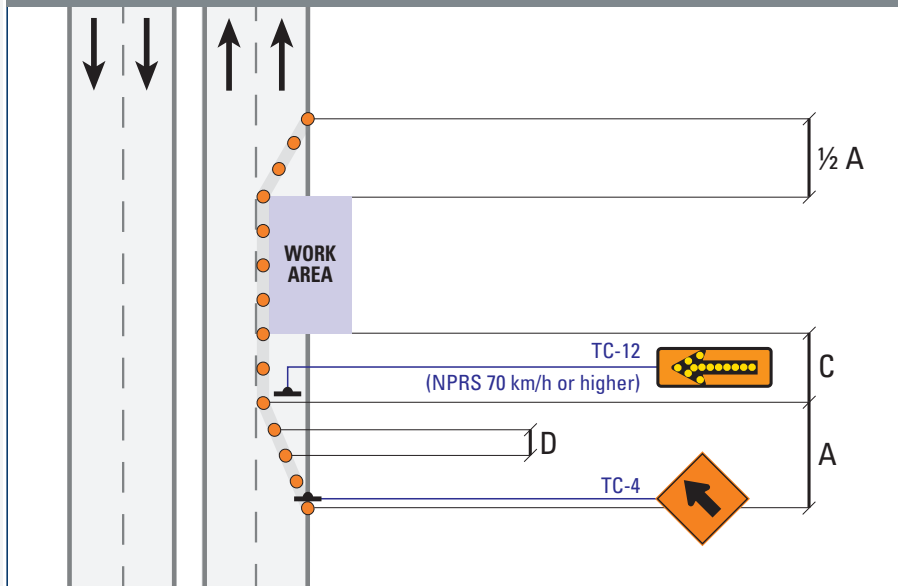

**Normal Posted Regulatory Speed (km/h)**

Label	Description	50	60	70	80	90
<b>A</b>	Taper Length for Full Lane Closure (m)	60	85	100	100	110
<b>C</b>	Longitudinal Buffer Area (LBA) (m)	(30)	(40)	50	60	75
<b>D</b>	Maximum Distance between Markers (m)	6	6	9	9	12
	Minimum Number of Markers for Taper	4	5	5	7	8
<b>F</b>	Distance between Construction Signs (m)	30	30	60	60	80

**DS-14 Left Lane Closed or Occupied**

**Multi-Lane Divided**    **Mobile Operations**    **Intermittent**    **Very Short Duration**    Short Duration    Long Duration

**NOTES**

i) Distance between Sign Truck and Work Vehicle may be adjusted to accommodate hills, curves, restricted visibility, or other site specific conditions.

\*The TC-4 sign must be installed at or just beyond the beginning of a lane closure taper.

For further detail on Work Zone components, see [Table A \(Mobile/Intermittent/Very Short, pg. 240\)](#).

**With Work Vehicle – Mobile, Intermittent, or VSD**

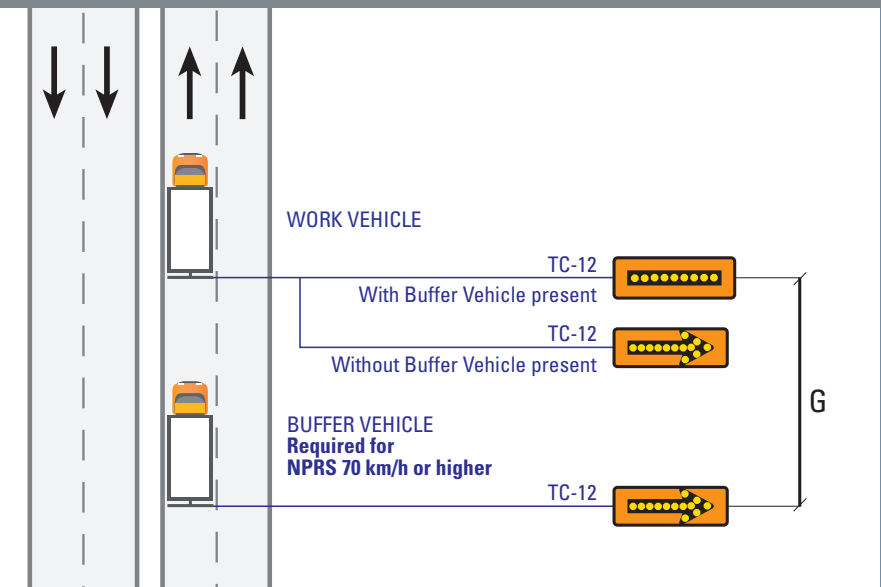

**Without Work Vehicle – VSD**

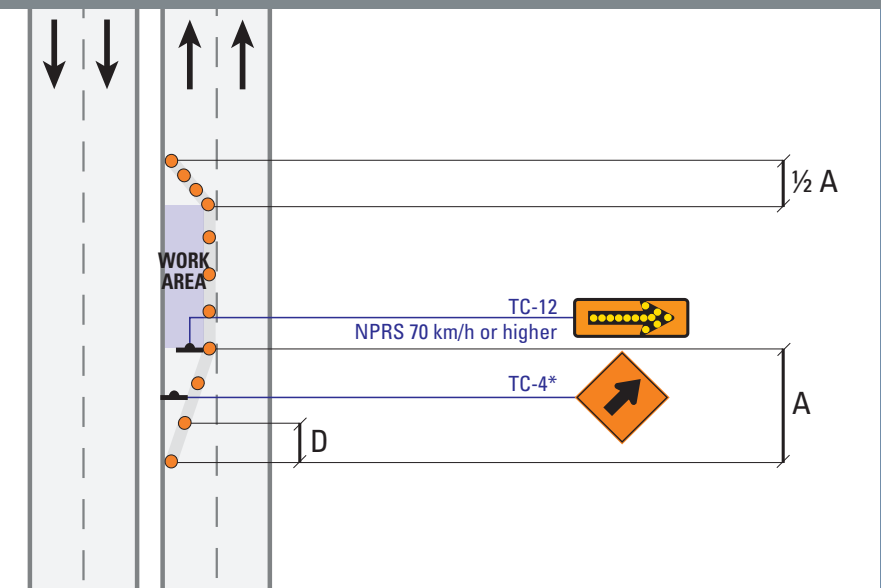

**Normal Posted Regulatory Speed (km/h)**

Label	Description	50	60	70	80	90
<b>A</b>	Taper Length for Full Lane Closure (m)	60	85	100	100	110
<b>D</b>	Maximum Distance between Markers (m)	6	6	9	9	12
	Minimum Number of Markers for Taper	4	5	5	7	8
<b>G</b>	Mobile Work: Lateral Intrusion Deterrence Gap (LIDG) (m)	–	–	9	9	50

**DS-15**

**Lane Closed**

**Multi-Lane Divided**

Mobile Operations

Intermittent

Very Short Duration

**Short Duration**

Long Duration

**NOTES**

i) Mirror image for Left Lane Closed.  
For Left Lane Closed, TC-3, TC-2B or TC-2A, TC-1 are to be repeated appropriately on opposite shoulder where NPRS is 70 km/h or higher.

\*The TC-4 sign must be installed at or just beyond the beginning of a lane closure taper.

For further detail on Work Zone components, see [Table B \(Short/Long, pg. 241\)](#).

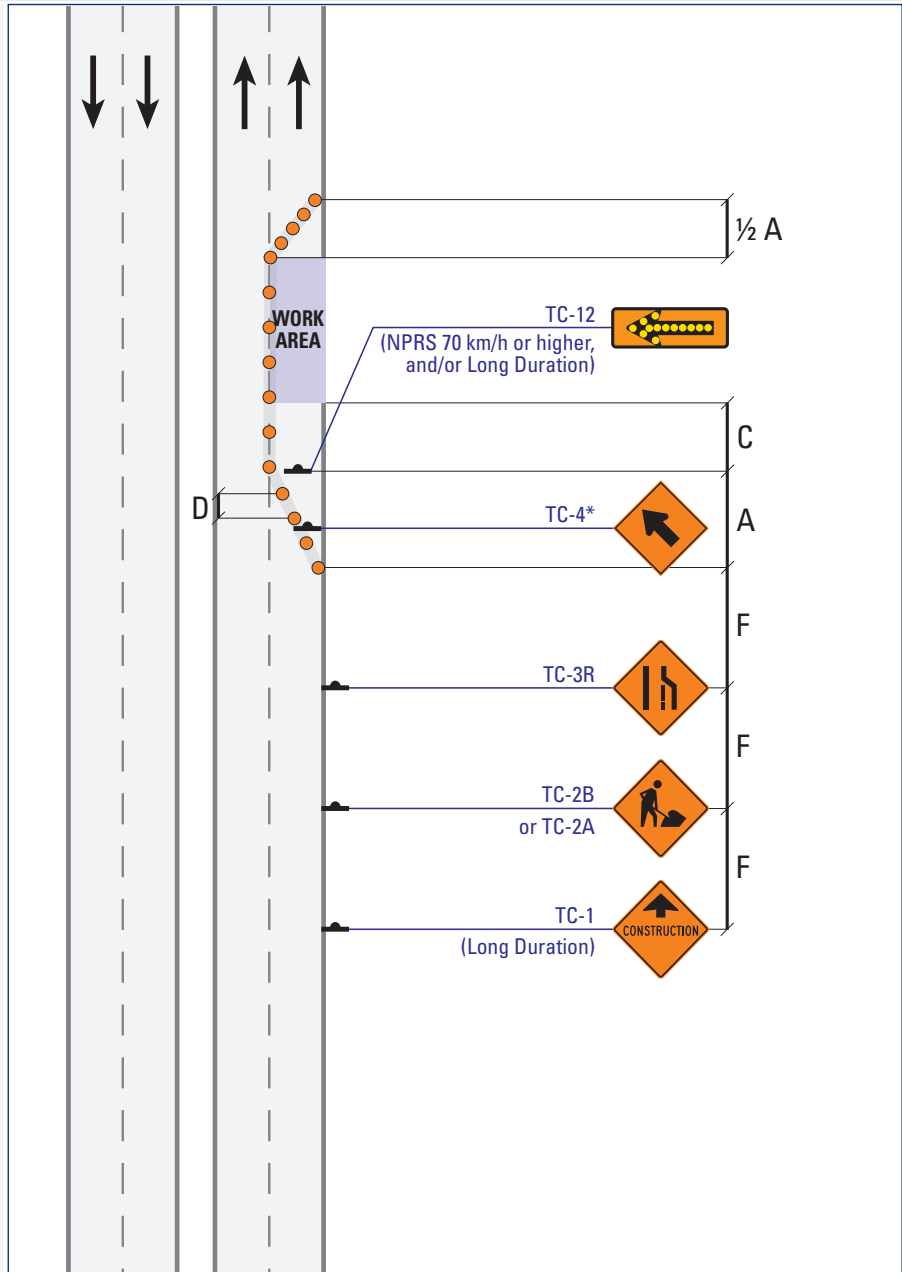

Label	Description	Normal Posted Regulatory Speed (km/h)				
		50	60	70	80	90
<b>A</b>	Taper Length for Full Lane Closure (m)	60	85	155	180	200
<b>C</b>	Longitudinal Buffer Area (LBA) (m)	(30)	(40)	50	60	75
<b>D</b>	Maximum Distance between Markers (m)	6	9	9	12	12
	Minimum Number of Markers for Taper	5	7	9	11	13
<b>F</b>	Distance between Construction Signs (m)	50	90	120	140	150

**DS-16** Six Lane Road: Left Two Lanes Closed

**Multi-Lane Divided** Mobile Operations Intermittent Very Short Duration Short Duration Long Duration

**NOTES**

i) Where sufficient space permits, TC-3L, TC-2, and TC-1 may be placed in the median.

ii) Right Lanes Closed: mirror image, except for TC-3, TC-2, and TC-1.

\*The TC-4 sign must be installed at or just beyond the beginning of a lane closure taper.

For further detail on Work Zone components, see [Table B \(Short/Long, pg. 241\)](#).

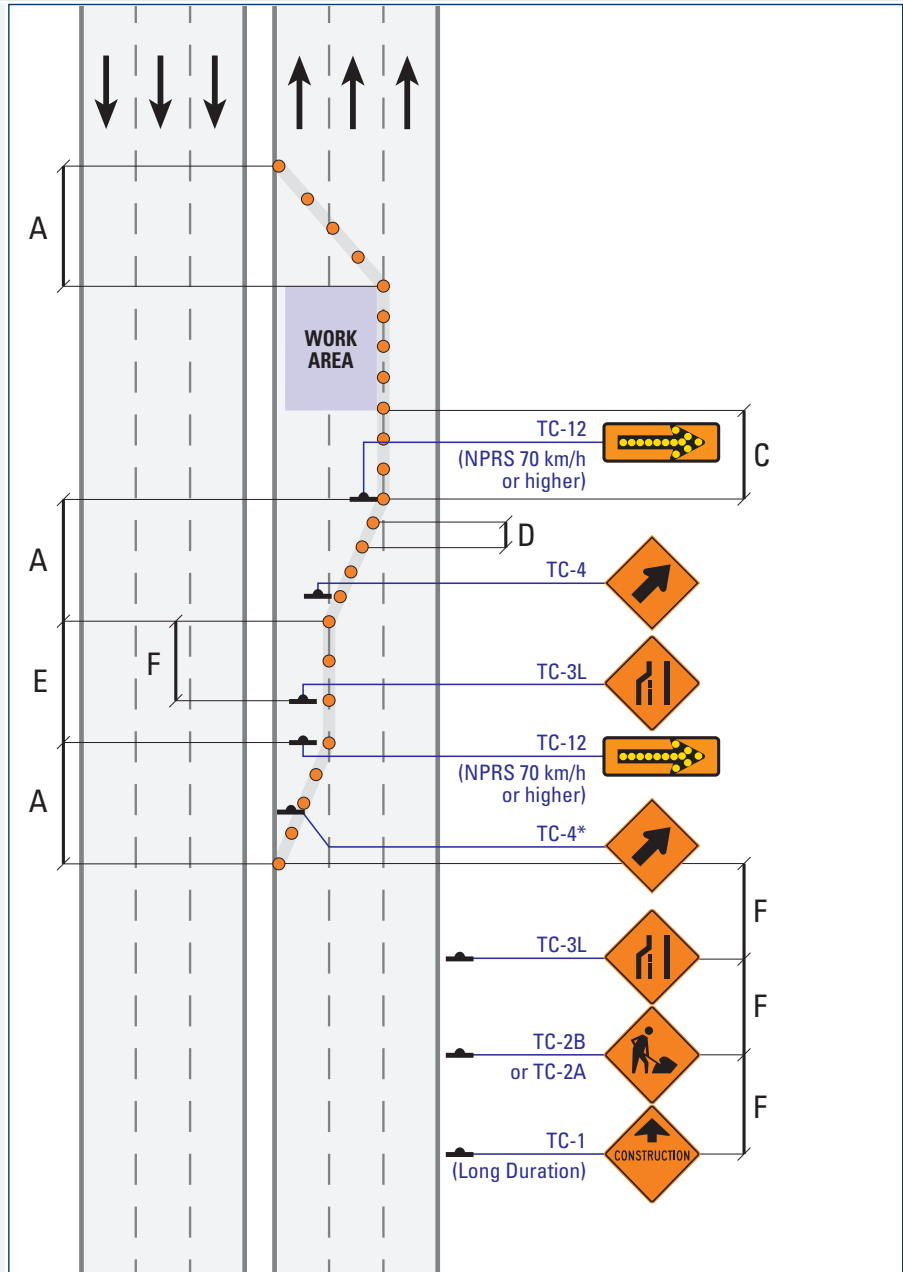

Normal Posted Regulatory Speed (km/h)

Label	Description	50	60	70	80	90
A	Taper Length for Full Lane Closure (m)	60	85	155	180	200
C	Longitudinal Buffer Area (LBA) (m)	(30)	(40)	50	60	75
D	Maximum Distance between Markers (m)	6	9	9	12	12
	Minimum Number of Markers for Taper	5	7	9	11	13
E	Minimum Tangent between Tapers (m)	60	85	155	180	200
F	Distance between Construction Signs (m)	50	90	120	140	150



**DS-17**

**Route Detour (Alternative Roads)**

**Multi-Lane Divided**

Mobile Operations

Intermittent

Very Short Duration

**Short Duration**

Long Duration

**NOTES**

- i) See DS-18 for Sign Details.
- ii) The same approach to signing is required in the opposite direction.
- iii) TC-54 can be used in place of TC-53A.
- iv) If space is insufficient to install a TC-67, it may be replaced with a TC-65.

For further detail on Work Zone components, see [Table B \(Short/Long, pg. 241\)](#).

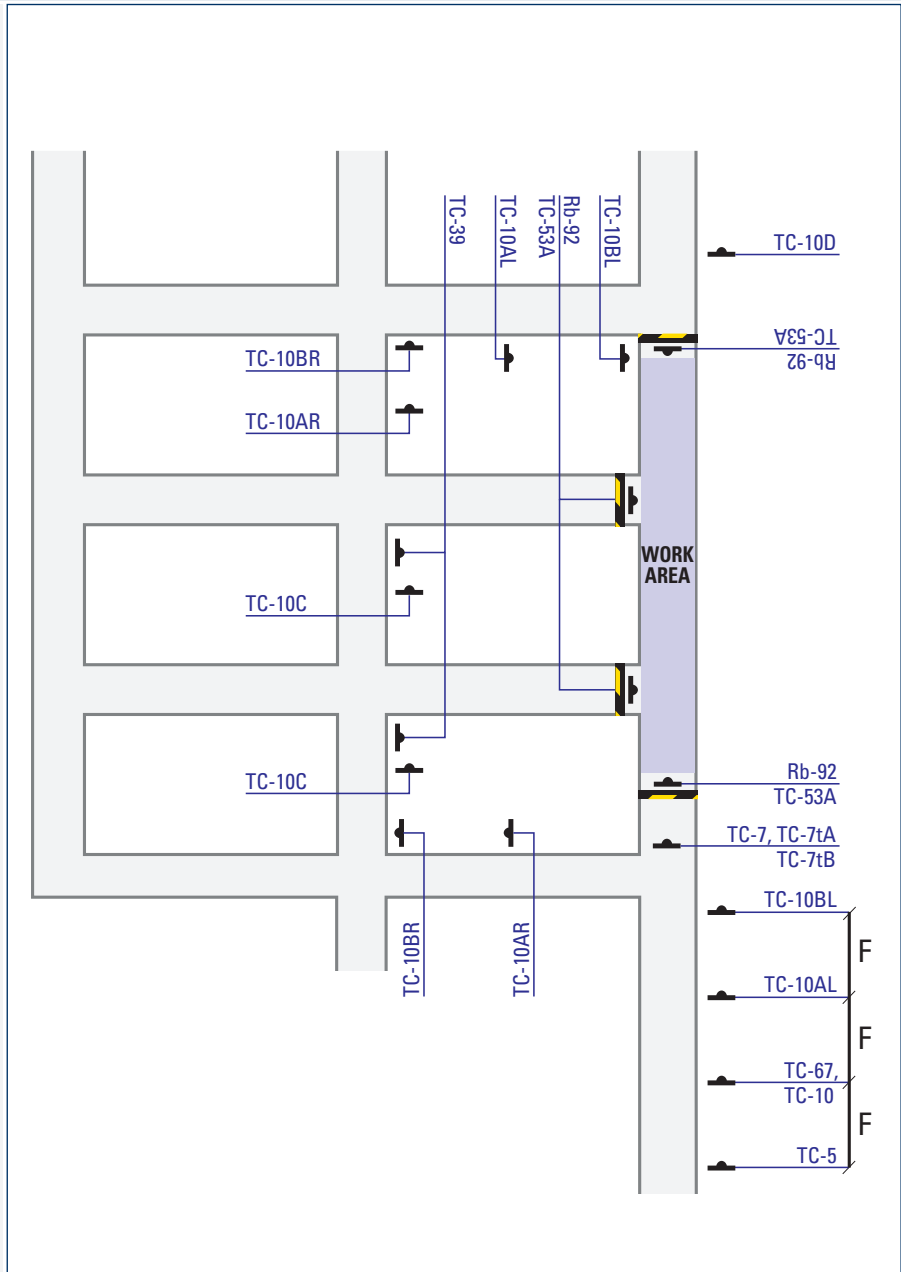

Label	Description	Normal Posted Regulatory Speed (km/h)				
		50	60	70	80	90
<b>F</b>	Distance between Construction Signs (m)	50	90	120	140	150

**DS-18**

**Detour Signs and Devices**

**Multi-Lane Divided**

Mobile Operations

Intermittent

Very Short Duration

**Short Duration**

Long Duration

**NOTES**

For further detail on Work Zone components, see [Table B \(Short/Long, pg. 241\)](#).

The following signs are to be used in the layout for Route Detour – see DS-17.



TC-10



TC-10AR

Other tabs may be used with the  sign as follows:



TC-10BR



TC-10C



TC-10ER



TC-10FR



TC-10AL



TC-10BL



TC-10D



TC-10EL



TC-10FL

Roundabout Fish-hook tabs:



TC-10BRr



TC-10ALr



TC-10Cr



TC-39



TC-5



Rb-92



TC-7

ROAD CLOSED

LOCAL TRAFFIC ONLY

TC-7tA

TC-7tB



TC-53A



TC-67

FOLLOW

D-1

TC-10

**DS-19**

**Pedestrian Accommodation: Vehicle Encroachment on Road/Sidewalk**

**Multi-Lane Divided**

Mobile Operations

Intermittent

**Very Short Duration**

Short Duration

Long Duration

**NOTES**

i) ▲ Location of Pedestrian Controllers if required (e.g., use of Booms or Hoists). Pedestrian passage under Boom is acceptable when Boom is not in motion and when Hoisting is not underway. Where activities at a Work Area could endanger the public (e.g., trenches, excavation), Pedestrian Barricades must be used.

For further detail on Work Zone components, see [Table A \(Mobile/Intermittent/Very Short, pg. 240\)](#).

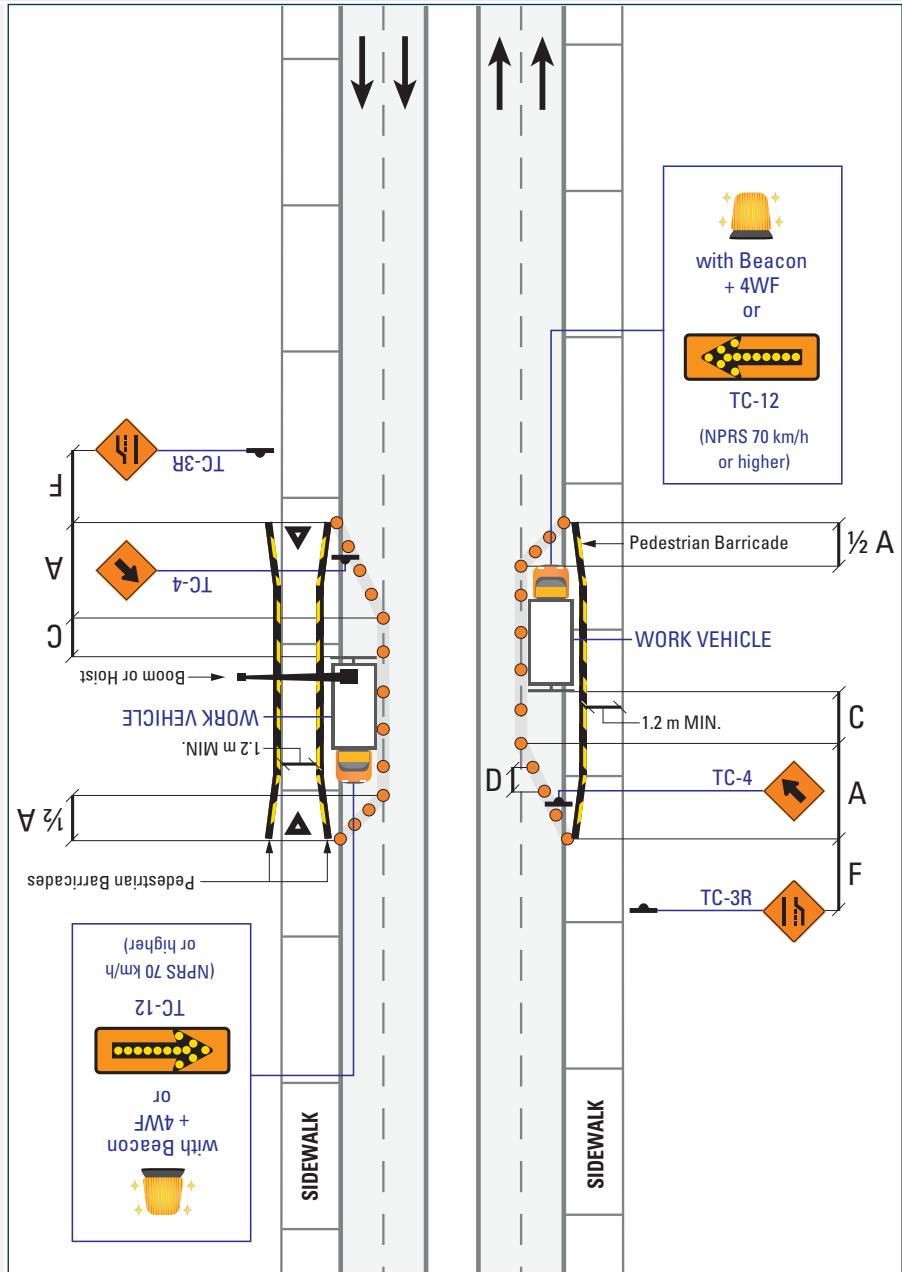

Label	Description	Normal Posted Regulatory Speed (km/h)				
		50	60	70	80	90
<b>A</b>	Taper Length for Full Lane Closure (m)	60	85	100	100	110
<b>C</b>	Longitudinal Buffer Area (LBA) (m)	(30)	(40)	50	60	75
<b>D</b>	Maximum Distance between Markers (m)	6	6	9	9	12
	Minimum Number of Markers for Taper	4	5	5	7	8
<b>F</b>	Distance between Construction Signs (m)	30	30	60	60	80

**DS-20**

**Pedestrian Accommodation: Vehicle Encroachment on Road/Sidewalk**

**Multi-Lane Divided**

Mobile Operations

Intermittent

Very Short Duration

Short Duration

Long Duration

**NOTES**

i) ▲ Location of Pedestrian Controllers if required (e.g., use of Booms or Hoists). Pedestrian passage under Boom is acceptable when Boom is not in motion and when Hoisting is not underway. Where activities at a Work Area could endanger the public (e.g., trenches, excavation), Pedestrian Barricades must be used.

For further detail on Work Zone components, see Table B (Short/Long, pg. 241).

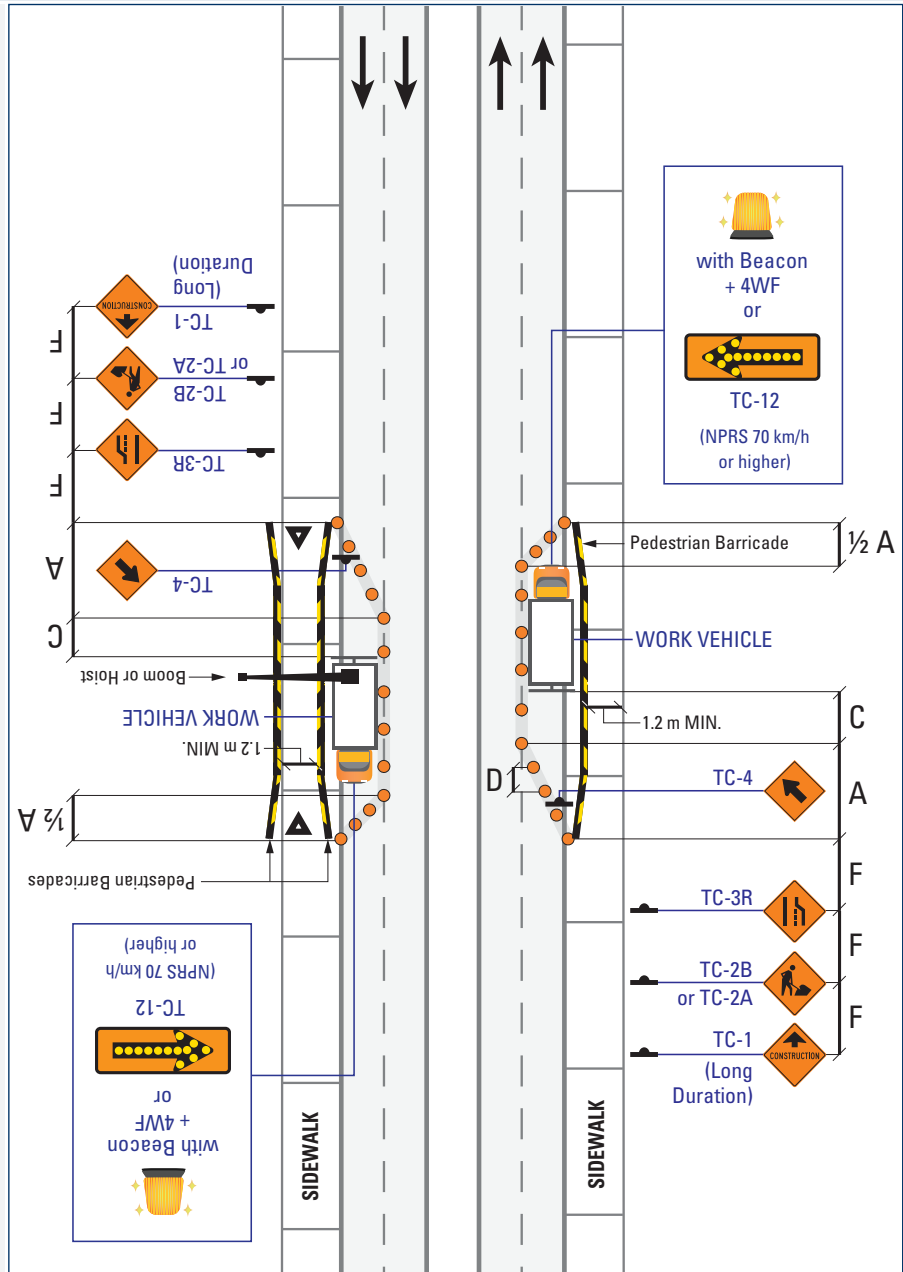

Normal Posted Regulatory Speed (km/h)

Label	Description	50	60	70	80	90
<b>A</b>	Taper Length for Full Lane Closure (m)	60	85	155	180	200
<b>C</b>	Longitudinal Buffer Area (LBA) (m)	(30)	(40)	50	60	75
<b>D</b>	Maximum Distance between Markers (m)	6	9	9	12	12
	Minimum Number of Markers for Taper	5	7	9	11	13
<b>F</b>	Distance between Construction Signs (m)	50	90	120	140	150

**DS-21**

**Pedestrian Accommodation: Mid-Block Sidewalk Detour onto Roadway**

**Multi-Lane Divided**

Mobile Operations

Intermittent

Very Short Duration

Short Duration

Long Duration

**NOTES**

- i) For Sidewalk Closures of Long Duration, a boardwalk and railing should be provided instead of Pedestrian Barricades.
- ii) If close to a crosswalk, pedestrians can be directed to the opposite side of the street with a TC-40 and TC-40T installed at the crosswalk.
- iii) Minimum width of the temporary walkway is 1.2 m.
- iv) AODA-compliant ramps are required if the curb is raised.

For further detail on Work Zone components, see [Table B \(Short/Long, pg. 241\)](#).

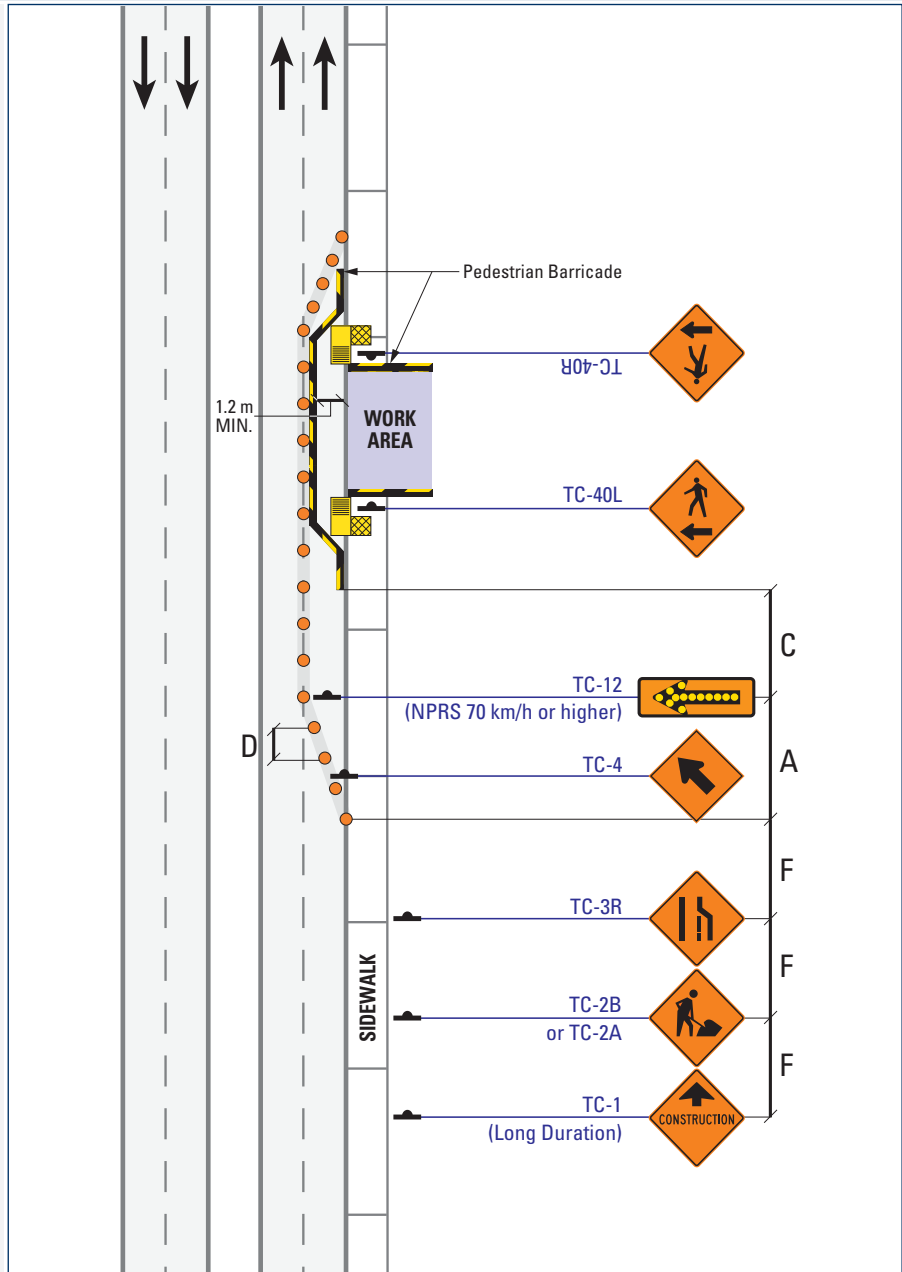

Label	Description	Normal Posted Regulatory Speed (km/h)				
		50	60	70	80	90
<b>A</b>	Taper Length for Full Lane Closure (m)	60	85	155	180	200
<b>C</b>	Longitudinal Buffer Area (LBA) (m)	(30)	(40)	50	60	75
<b>D</b>	Maximum Distance between Markers (m)	6	9	9	12	12
	Minimum Number of Markers for Taper	5	7	9	11	13
<b>F</b>	Distance between Construction Signs (m)	50	90	120	140	150

**DS-22**

**Pedestrian Detour: Sidewalk Closure**

**Multi-Lane Divided**

Mobile Operations

Intermittent

Very Short Duration

**Short Duration**

**Long Duration**

**NOTES**

i) TC-40L/R Pedestrian Direction sign must be placed at the nearest upstream controlled pedestrian crossing (traffic signal of Pedestrian Crossover) in each direction.

For further detail on Work Zone components, see [Table B \(Short/Long, pg. 241\)](#).

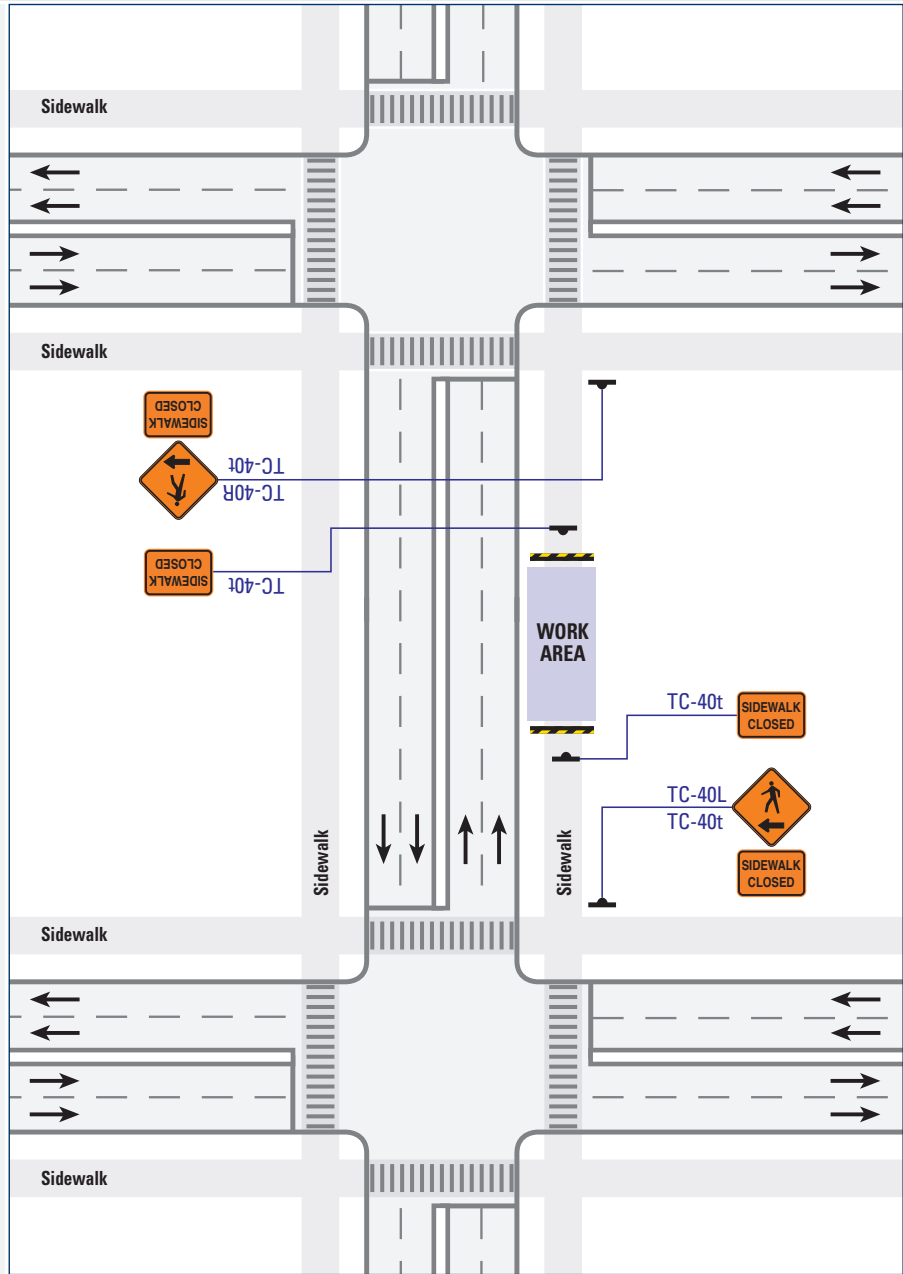

**DS-23 Bicycle Lane Diversion: Bicycle Lane Shift**

Multi-Lane Undivided    Mobile Operations    Intermittent    Very Short Duration    **Short Duration**    Long Duration

**NOTES**

- i) If space permits, TC-54 should be used in place of TC-51.
- ii) AODA-compliant ramps are required if the curb is raised.

For further detail on Work Zone components, see [Table B \(Short/Long, pg. 241\)](#).

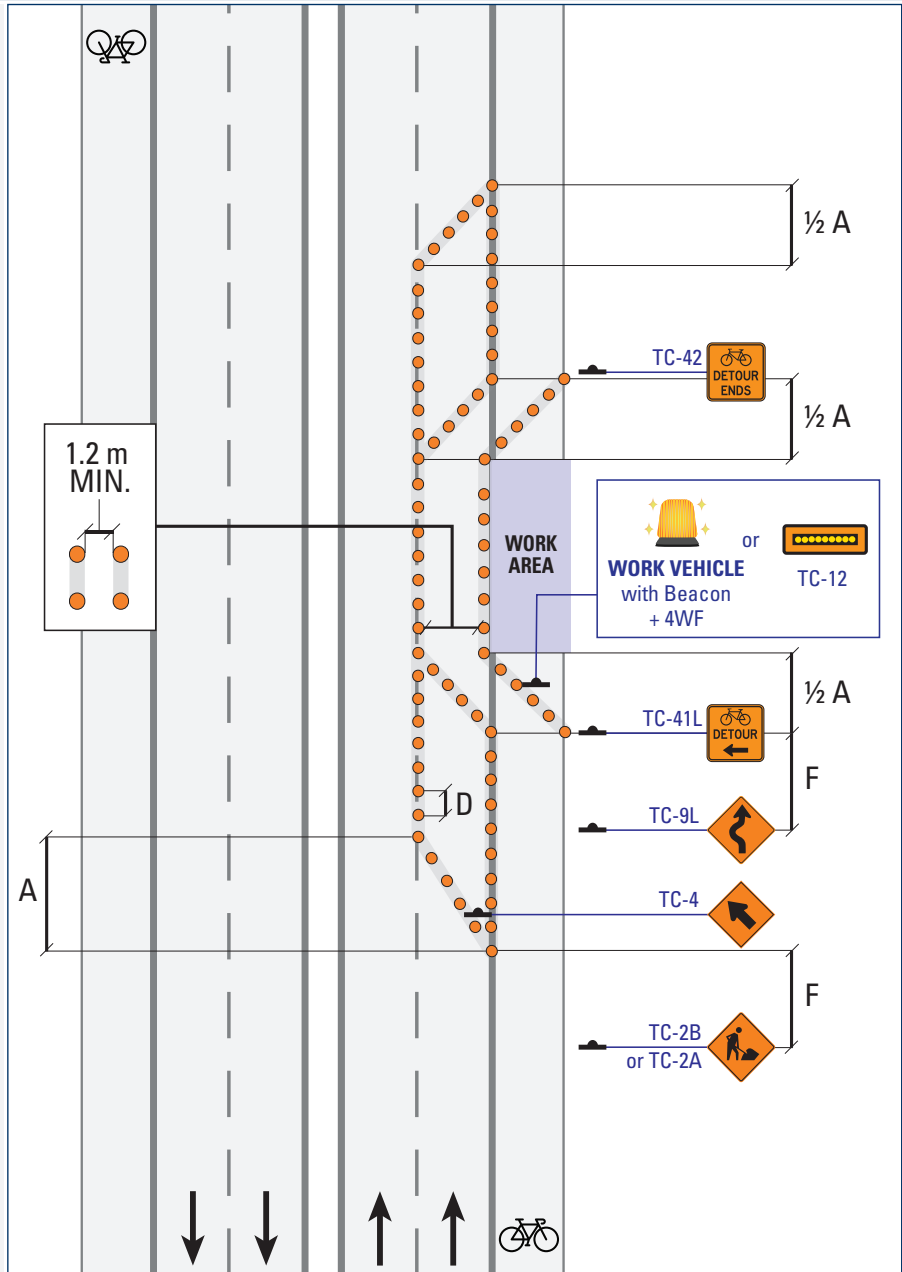

Label	Description	Normal Posted Regulatory Speed (km/h)				
		50	60	70	80	90
<b>A</b>	Taper Length for Full Lane Closure (m)	60	85	155	180	200
<b>D</b>	Maximum Distance between Markers (m)	6	9	9	12	12
	Minimum Number of Markers for Taper	5	7	9	11	13
<b>F</b>	Distance between Construction Signs (m)	50	90	120	140	150

**DS-24 Bicycle Lane Diversion: Bicycle Lane Shift**

**Multi-Lane Divided**    Mobile Operations    Intermittent    Very Short Duration    Short Duration    Long Duration

**NOTES**

i) If space permits, TC-54 should be used in place of TC-51.

ii) AODA-compliant ramps are required if the curb is raised.

For further detail on Work Zone components, see [Table B \(Short/Long, pg. 241\)](#).

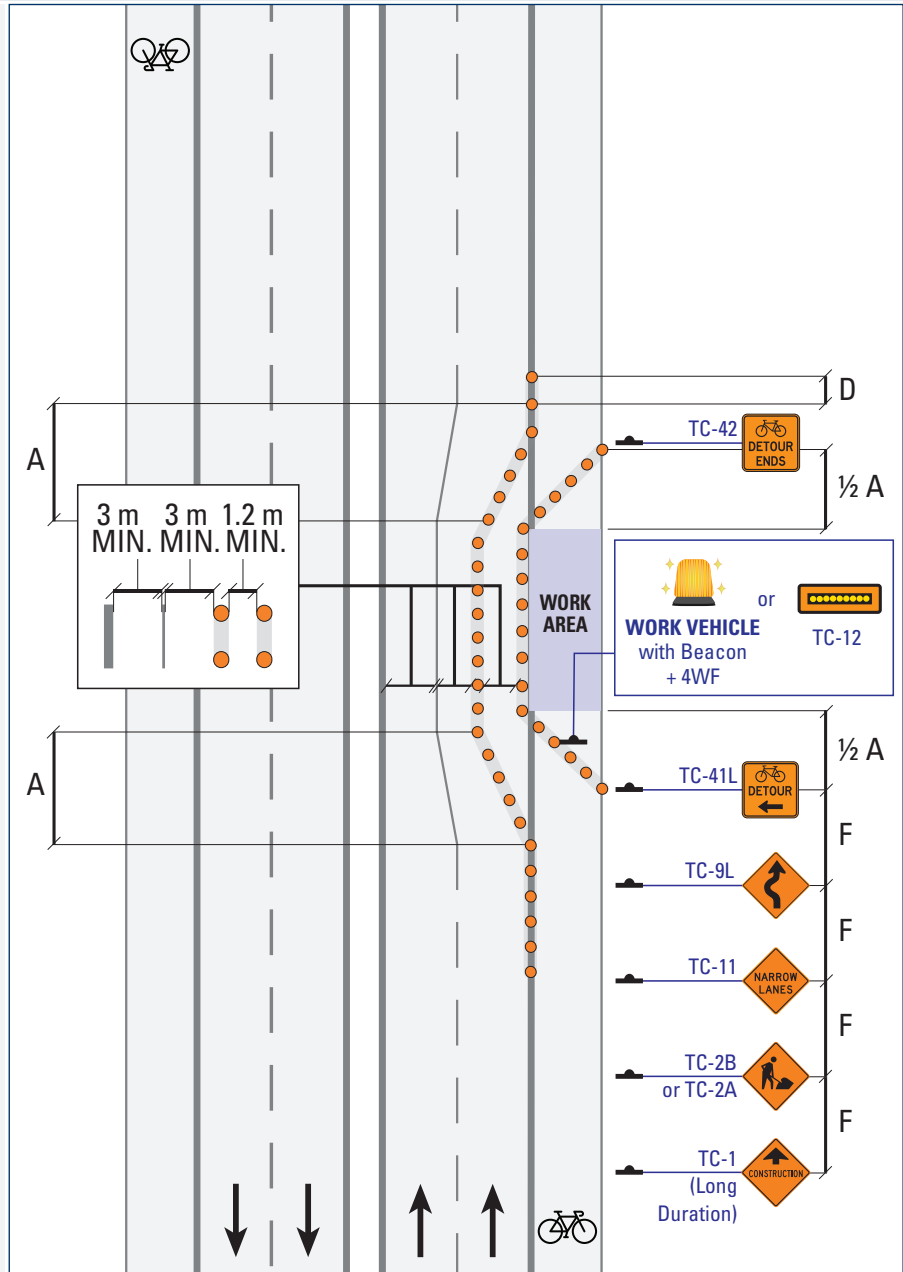

Label	Description	Normal Posted Regulatory Speed (km/h)				
		50	60	70	80	90
<b>A</b>	Taper Length for Full Lane Closure (m)	60	85	155	180	200
<b>D</b>	Maximum Distance between Markers (m)	6	9	9	12	12
	Minimum Number of Markers for Taper	5	7	9	11	13
<b>F</b>	Distance between Construction Signs (m)	50	90	120	140	150



**DS-25 Bicycle Lane Diversion: Temporary Path**

Multi-Lane Divided    Mobile Operations    Intermittent    Very Short Duration    **Short Duration**    Long Duration

**NOTES**

For further detail on Work Zone components, see [Table B \(Short/Long, pg. 241\)](#).

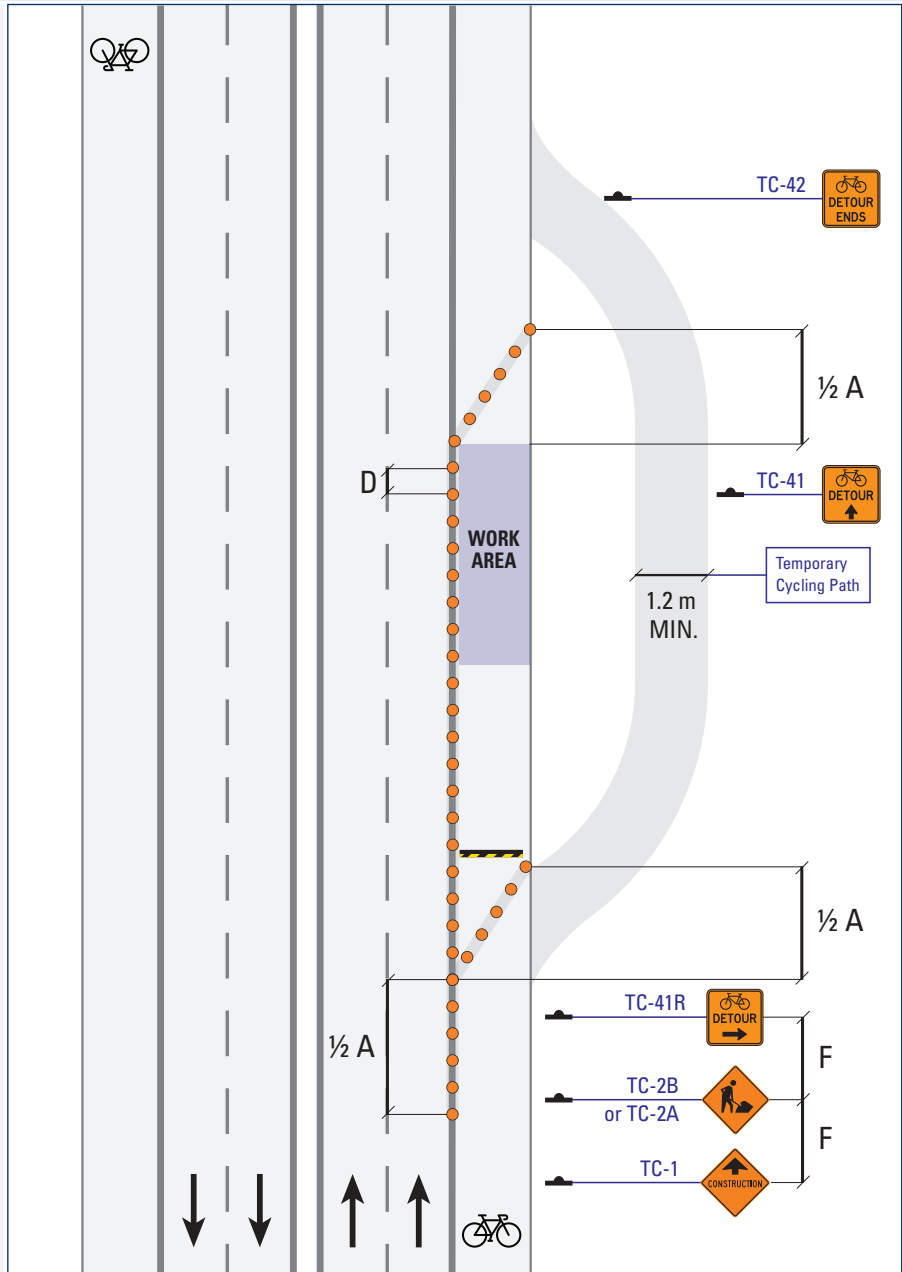

Label	Description	Normal Posted Regulatory Speed (km/h)				
		50	60	70	80	90
<b>A</b>	Taper Length for Full Lane Closure (m)	60	85	155	180	200
<b>D</b>	Maximum Distance between Markers (m)	6	9	9	12	12
	Minimum Number of Markers for Taper	5	7	9	11	13
<b>F</b>	Distance between Construction Signs (m)	50	90	120	140	150

**DS-26 Bicycle Lane Diversion: Single File**

Multi-Lane Divided    Mobile Operations    Intermittent    Very Short Duration    Short Duration    Long Duration

**NOTES**

i) AODA-compliant ramps are required if the curb is raised.

ii) Ensure signage is visible for drivers to be aware of merging cyclists.

**Shared lane only to be used if considered by OTM Book 18 or MTO Bikeways Design Manual, Desirable Cycling Facility Nomograph. Otherwise, cycling Detour should be provided.**

For further detail on Work Zone components, see [Table B \(Short/Long, pg. 241\)](#).

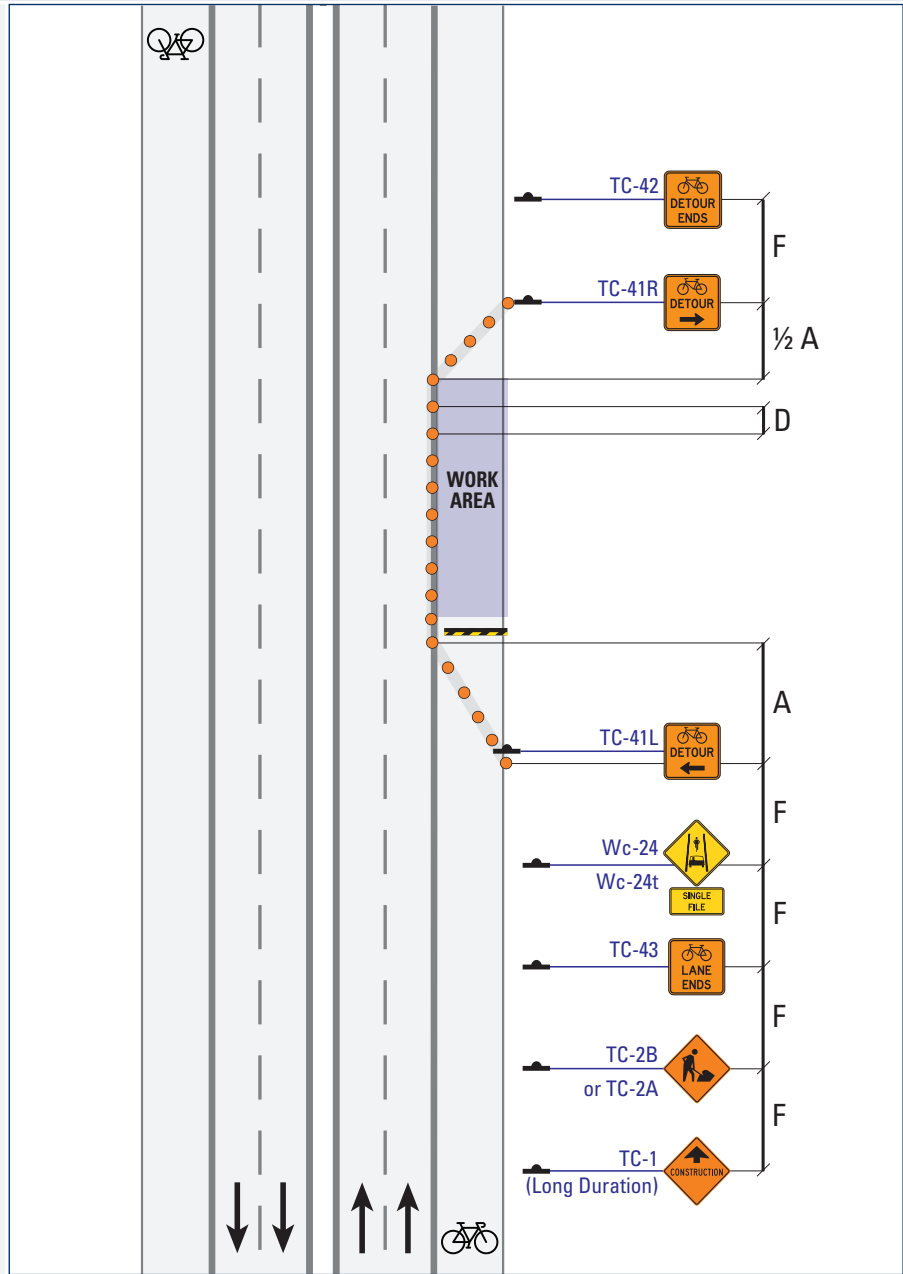

Normal Posted Regulatory Speed (km/h)

Label	Description	50	60	70	80	90
<b>A</b>	Taper Length for Full Lane Closure (m)	60	85	155	180	200
<b>D</b>	Maximum Distance between Markers (m)	6	9	9	12	12
	Minimum Number of Markers for Taper	5	7	9	11	13
<b>F</b>	Distance between Construction Signs (m)	50	90	120	140	150

**DI-1 Zone Painting: Intersection Turn Arrows**

**Multi-Lane Divided**

Mobile Operations

Intermittent

**Very Short Duration**

Short Duration

Long Duration

**NOTES**

i) It may be necessary to prohibit left turns.

For further detail on Work Zone components, see [Table A \(Mobile/Intermittent/Very Short, pg. 240\)](#).

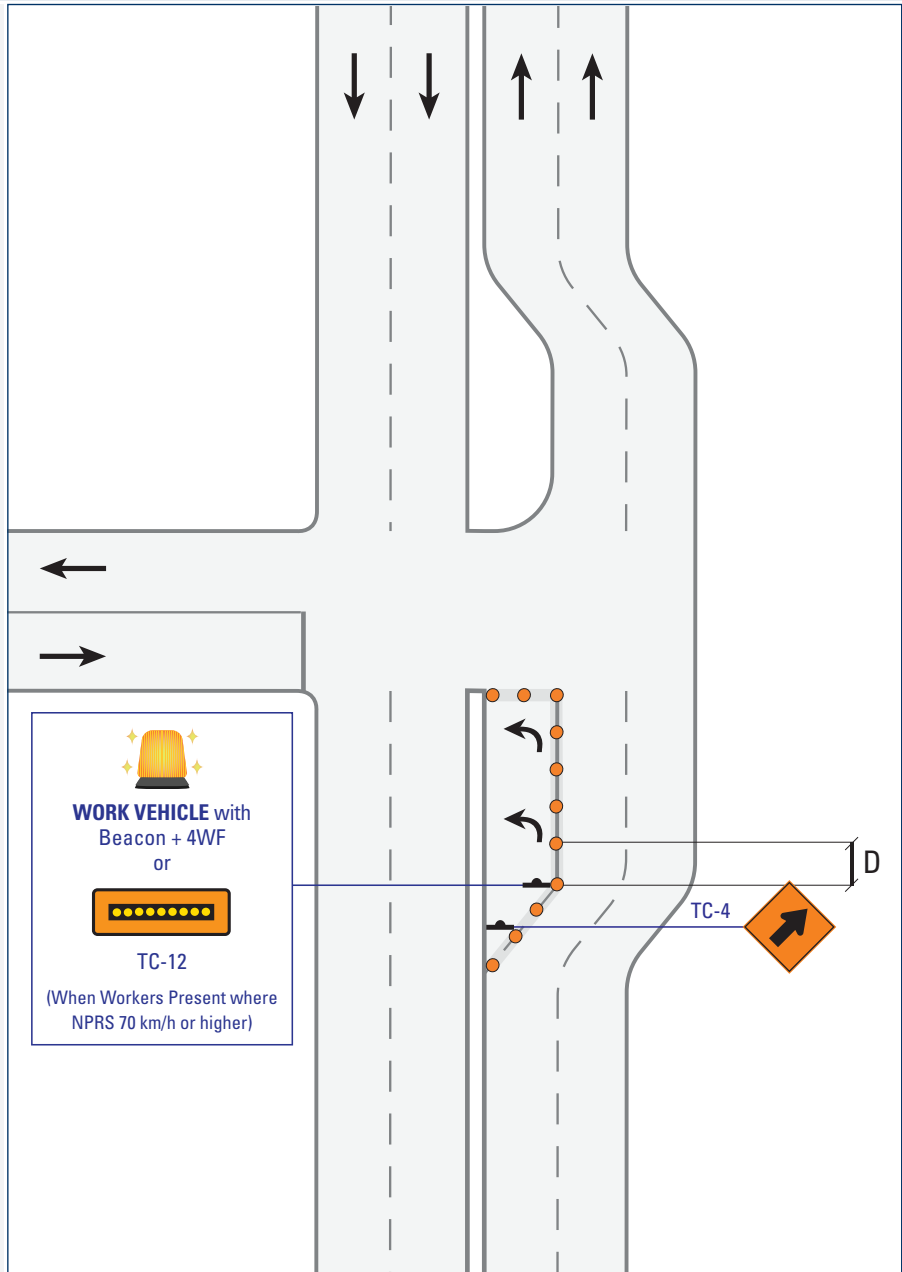

Label	Description	Normal Posted Regulatory Speed (km/h)				
		50	60	70	80	90
<b>D</b>	Maximum Distance between Markers (m)	6	6	9	9	12
	Minimum Number of Markers for Taper	4	5	5	7	8

**DI-2 Zone Painting: Intersection Turn Arrows**

**Multi-Lane Divided**

Mobile Operations

Intermittent

Very Short Duration

**Short Duration**

Long Duration

**NOTES**

i) It may be necessary to prohibit left turns.

For further detail on Work Zone components, see [Table B \(Short/Long, pg. 241\)](#).

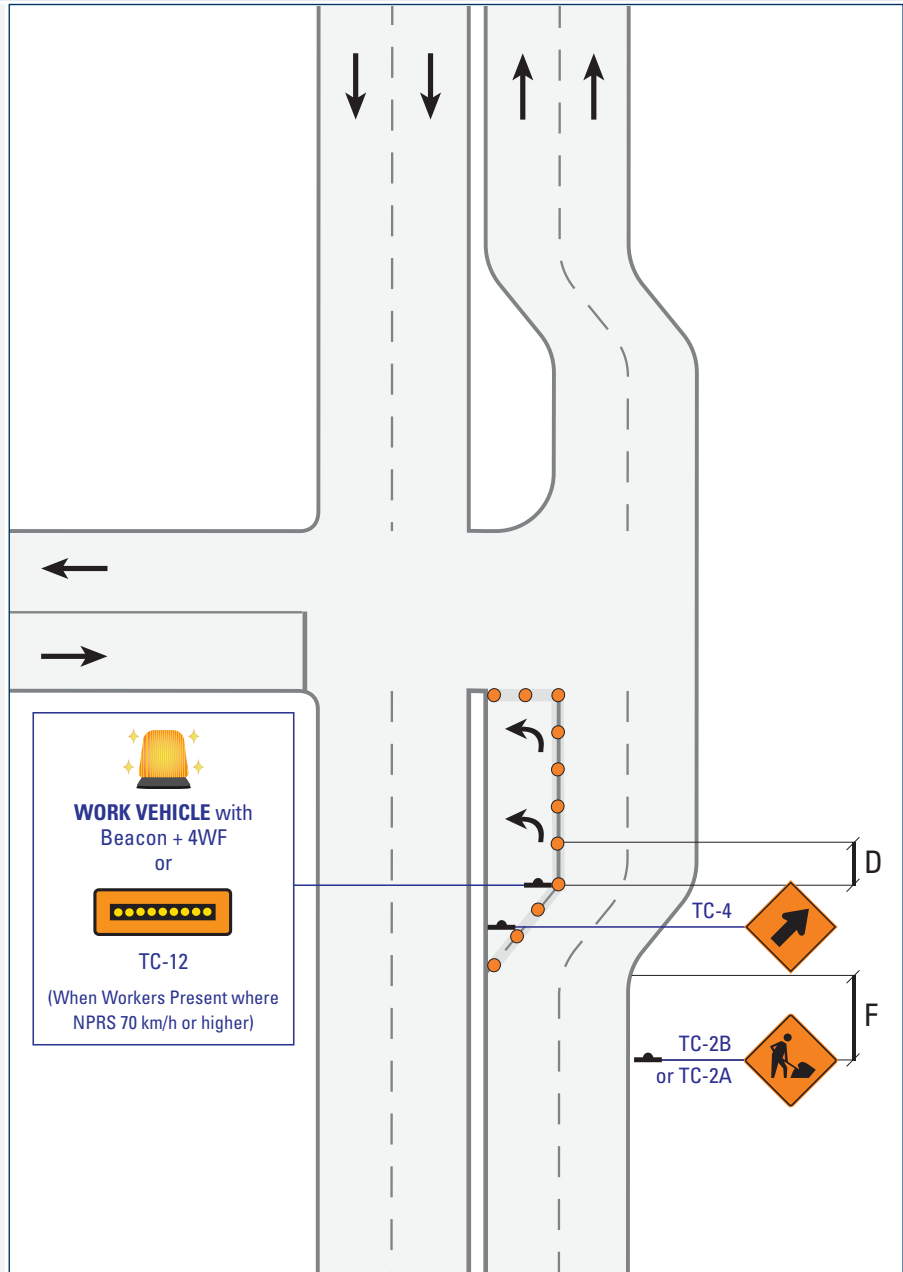

Label	Description	Normal Posted Regulatory Speed (km/h)				
		50	60	70	80	90
<b>D</b>	Maximum Distance between Markers (m)	6	9	9	12	12
	Minimum Number of Markers for Taper	5	7	9	11	13
<b>F</b>	Distance between Construction Signs (m)	50	90	120	140	150

**DI-3 Zone Painting: Intersection Left Lane Closed**

Multi-Lane Divided    Mobile Operations    Intermittent    **Very Short Duration**    Short Duration    Long Duration

**NOTES**

For further detail on Work Zone components, see [Table A \(Mobile/Intermittent/Very Short, pg. 240\)](#).

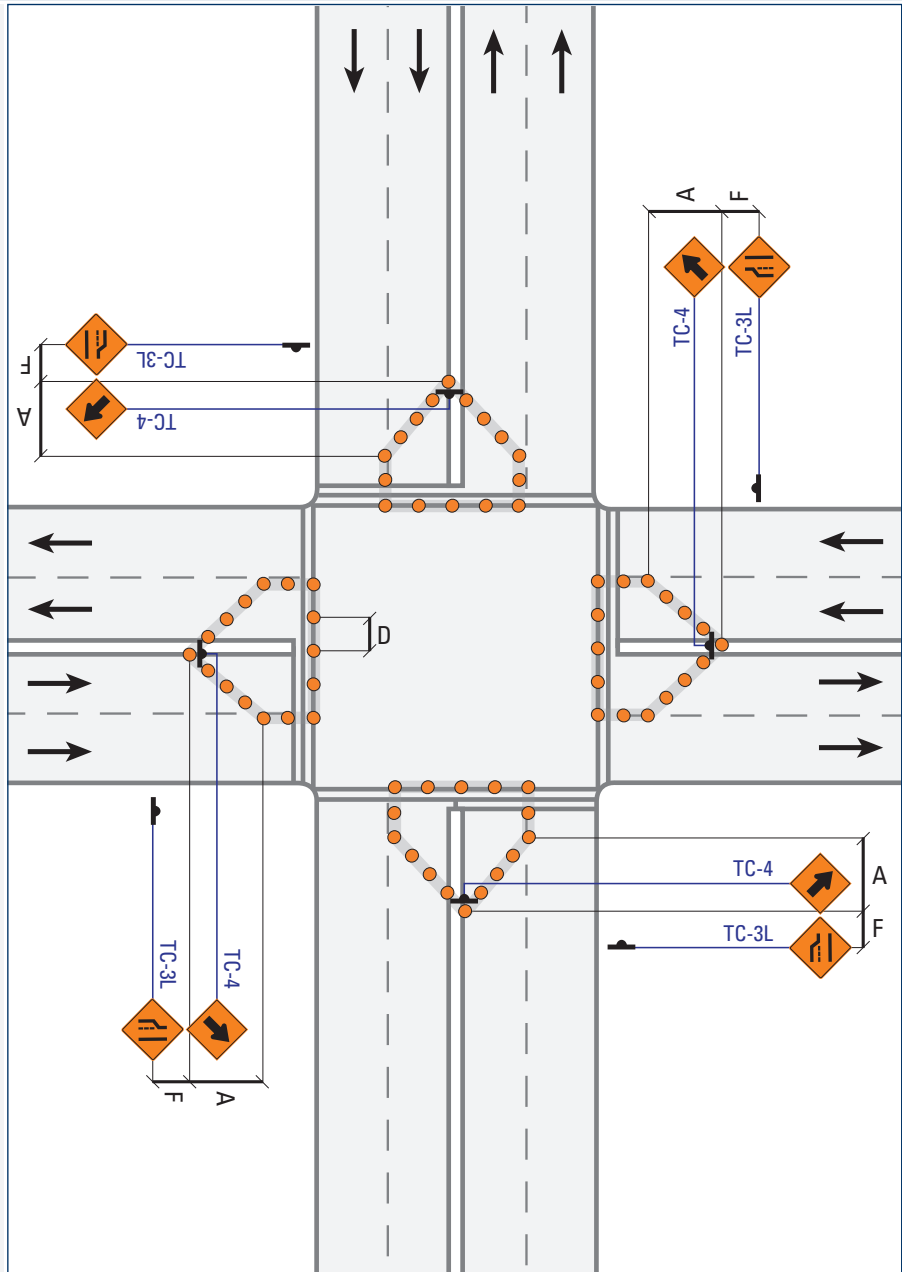

Label	Description	Normal Posted Regulatory Speed (km/h)				
		50	60	70	80	90
<b>A</b>	Taper Length for Full Lane Closure (m)	60	85	100	100	110
<b>D</b>	Maximum Distance between Markers (m)	6	6	9	9	12
	Minimum Number of Markers for Taper	4	5	5	7	8
<b>F</b>	Distance between Construction Signs (m)	30	30	60	60	80

**DI-4 Zone Painting: Intersection Left Lane Closed**

**Multi-Lane Divided**    Mobile Operations    Intermittent    Very Short Duration    **Short Duration**    Long Duration

**NOTES**

For further detail on Work Zone components, see [Table B \(Short/Long, pg. 241\)](#).

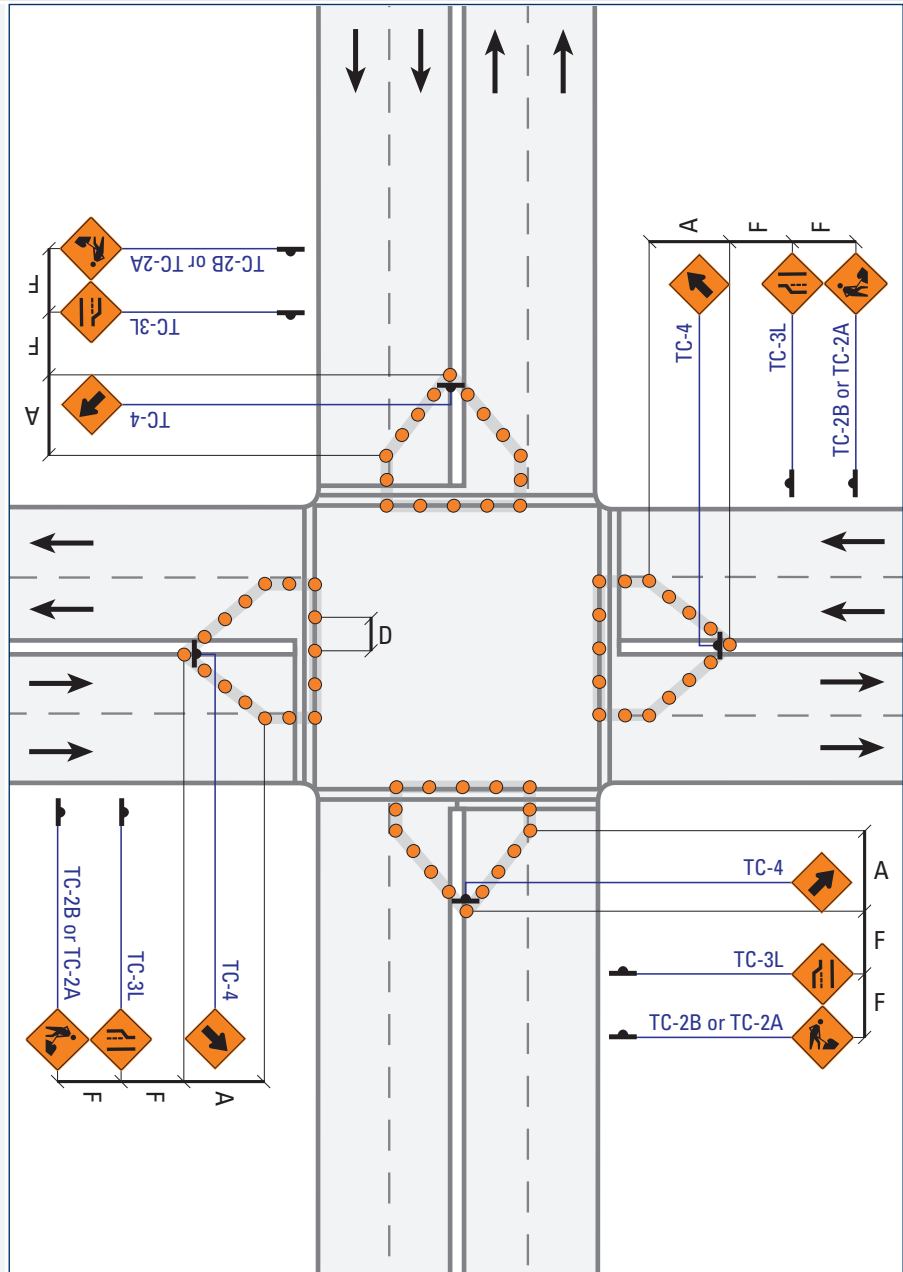

Label	Description	Normal Posted Regulatory Speed (km/h)				
		50	60	70	80	90
<b>A</b>	Taper Length for Full Lane Closure (m)	60	85	155	180	200
<b>D</b>	Maximum Distance between Markers (m)	6	9	9	12	12
	Minimum Number of Markers for Taper	5	7	9	11	13
<b>F</b>	Distance between Construction Signs (m)	50	90	120	140	150

**DI-5 Zone Painting: Intersection Right Lane Closed**

**Multi-Lane Divided**

Mobile Operations

Intermittent

**Very Short Duration**

Short Duration

Long Duration

**NOTES**

For further detail on Work Zone components, see [Table A \(Mobile/Intermittent/Very Short, pg. 240\)](#).

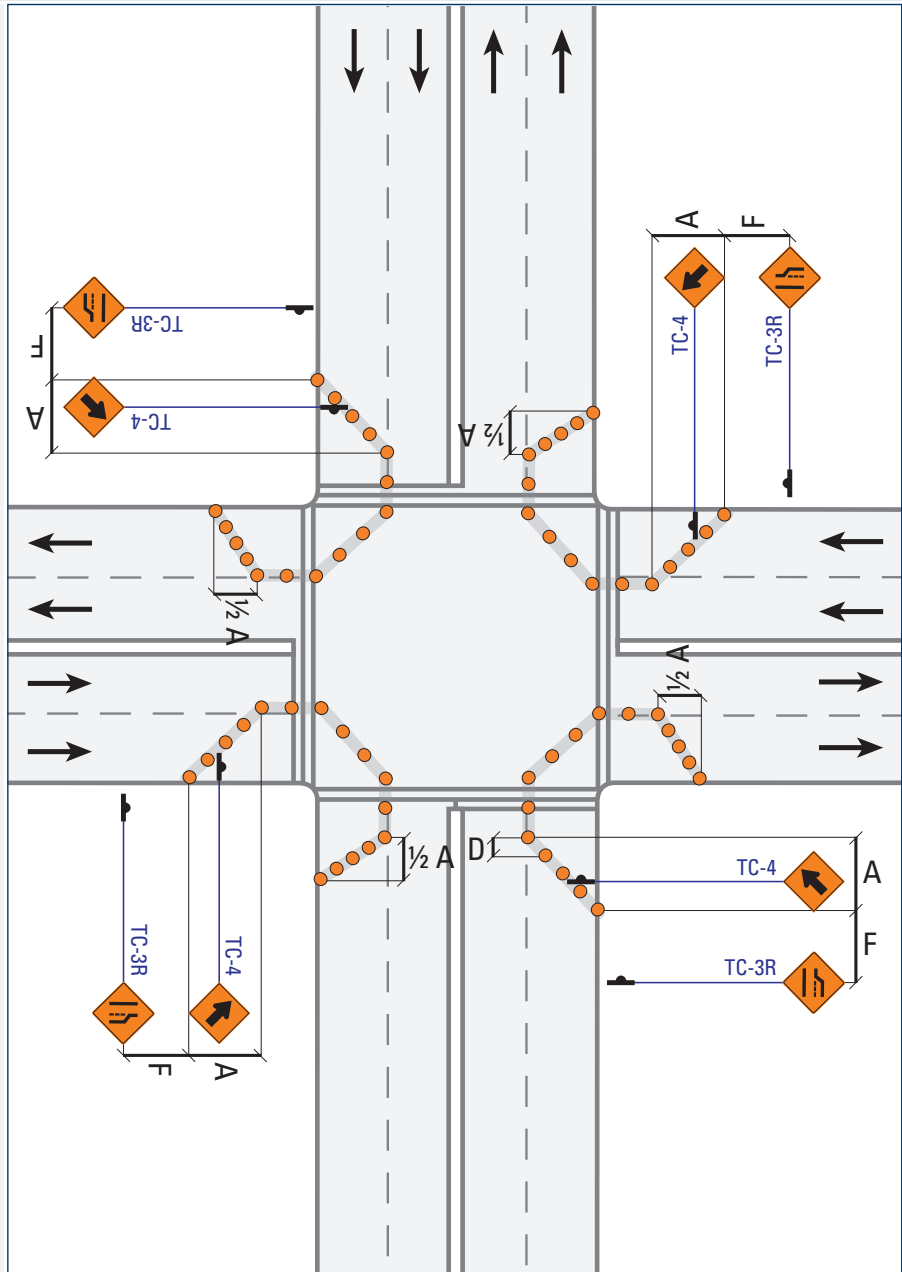

Label	Description	Normal Posted Regulatory Speed (km/h)				
		50	60	70	80	90
<b>A</b>	Taper Length for Full Lane Closure (m)	60	85	100	100	110
<b>D</b>	Maximum Distance between Markers (m)	6	6	9	9	12
	Minimum Number of Markers for Taper	4	5	5	7	8
<b>F</b>	Distance between Construction Signs (m)	30	30	60	60	80

**DI-6 Zone Painting: Intersection Right Lane Closed**

**Multi-Lane Divided**    Mobile Operations    Intermittent    Very Short Duration    **Short Duration**    Long Duration

**NOTES**

For further detail on Work Zone components, see [Table B \(Short/Long, pg. 241\)](#).

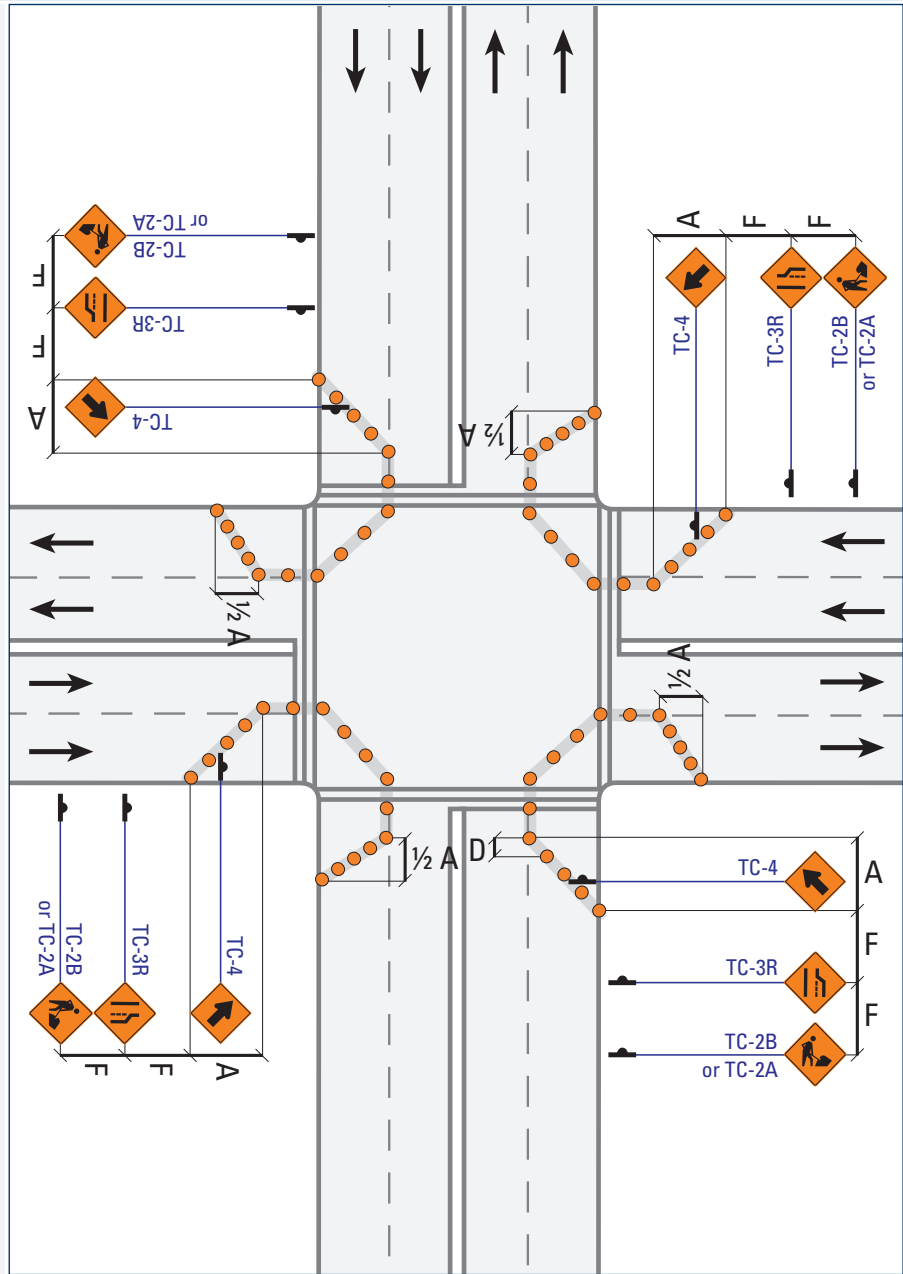

Normal Posted Regulatory Speed (km/h)

Label	Description	50	60	70	80	90
<b>A</b>	Taper Length for Full Lane Closure (m)	60	85	155	180	200
<b>D</b>	Maximum Distance between Markers (m)	6	9	9	12	12
	Minimum Number of Markers for Taper	5	7	9	11	13
<b>F</b>	Distance between Construction Signs (m)	50	90	120	140	150



**DI-7 Intersection: Near-Side Right or Left Through Lane Closed**

**Multi-Lane Divided**

Mobile Operations

Intermittent

**Very Short Duration**

Short Duration

Long Duration

**NOTES**

i) Right Through Lane Closed mirror image (for Markers, TC-12, TC-4).

For further detail on Work Zone components, see [Table A \(Mobile/Intermittent/Very Short, pg. 240\)](#).

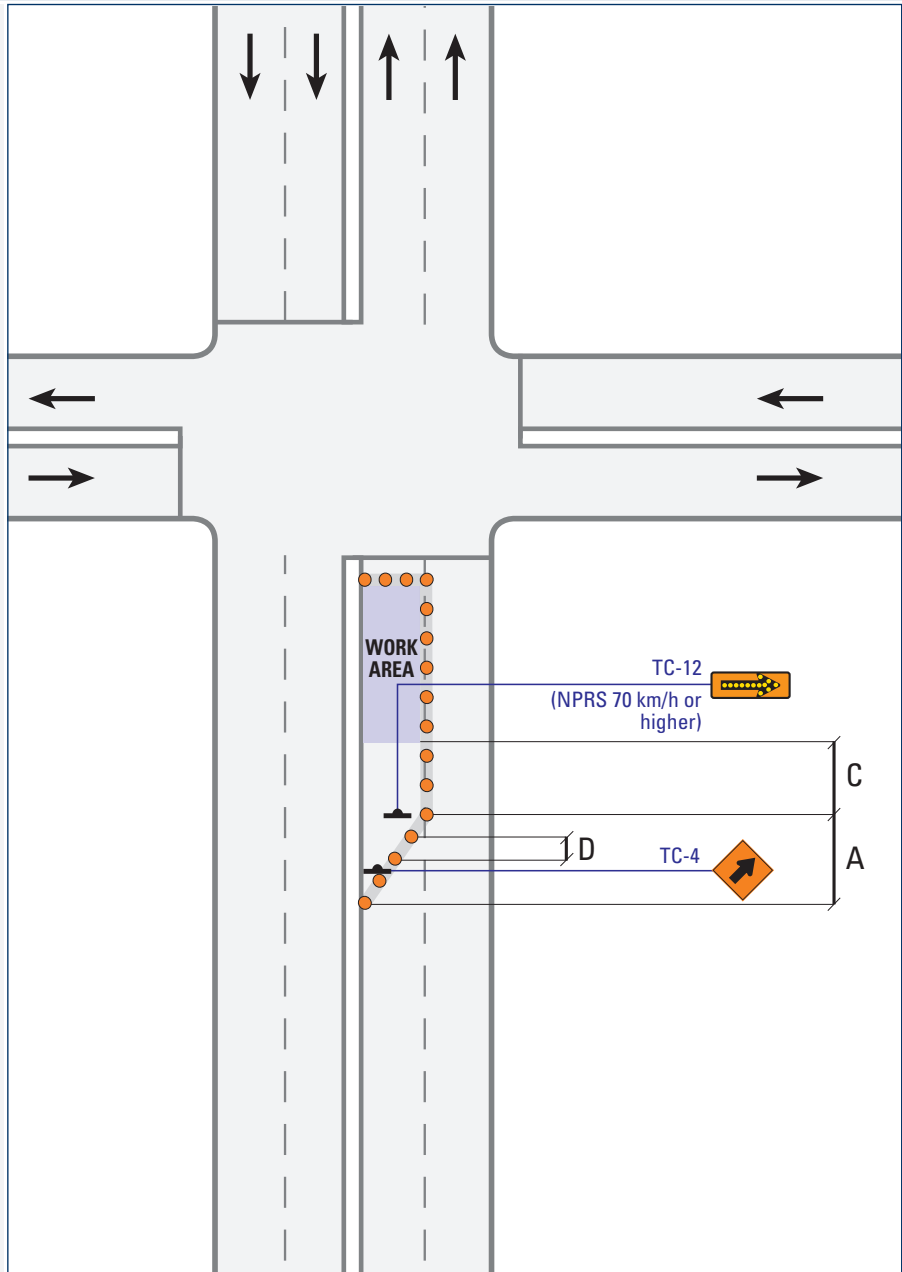

Label	Description	Normal Posted Regulatory Speed (km/h)				
		50	60	70	80	90
<b>A</b>	Taper Length for Full Lane Closure (m)	60	85	100	100	110
<b>C</b>	Longitudinal Buffer Area (LBA) (m)	(30)	(40)	50	60	75
<b>D</b>	Maximum Distance between Markers (m)	6	6	9	9	12
	Minimum Number of Markers for Taper	4	5	5	7	8

**DI-8**

**Intersection: Near-Side Right or Left Through Lane Closed**

**Multi-Lane Divided**

Mobile Operations

Intermittent

Very Short Duration

Short Duration

Long Duration

**NOTES**

i) Right Through Lane Closed mirror image (for Markers, TC-12, TC-4).

For further detail on Work Zone components, see [Table B \(Short/Long, pg. 241\)](#).

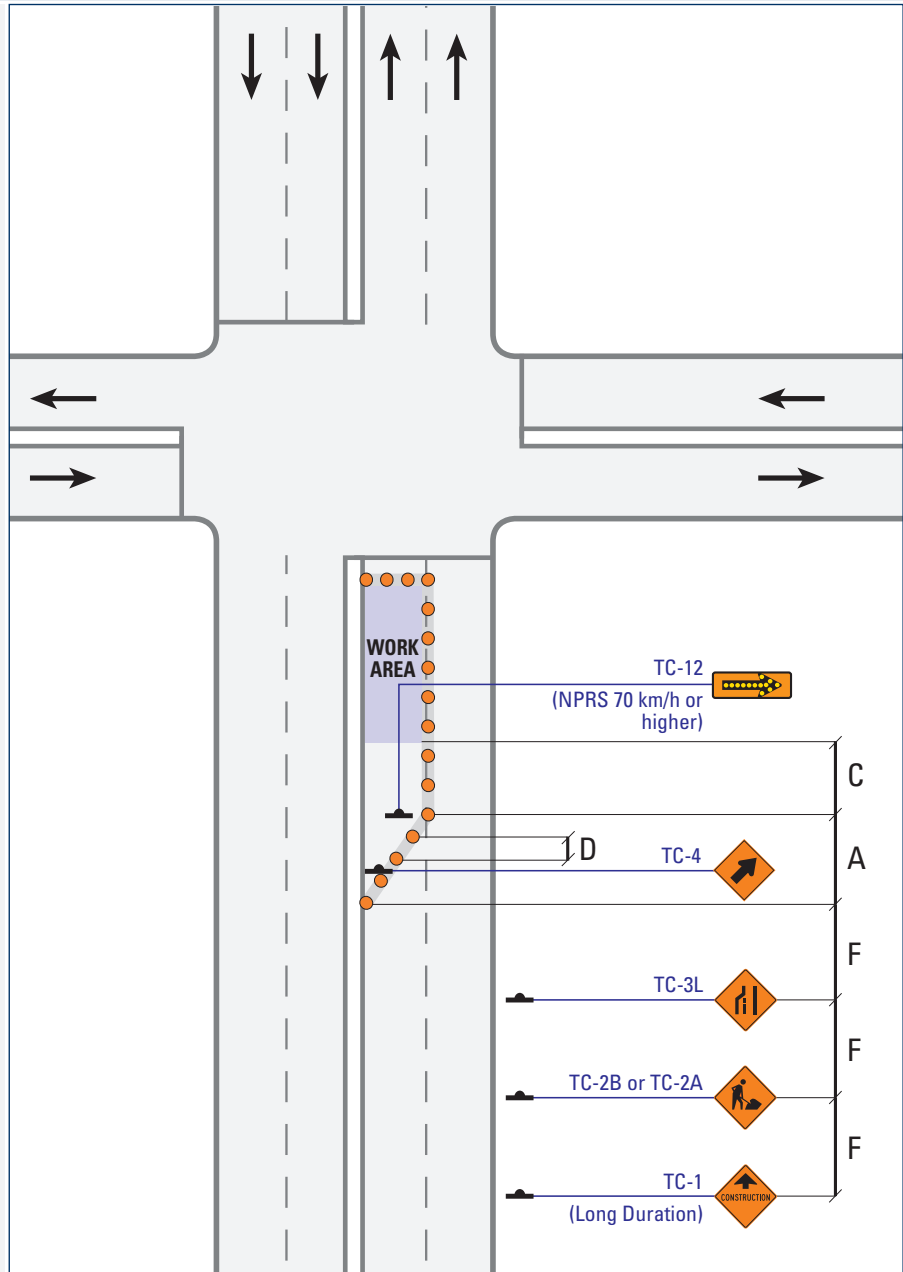

Normal Posted Regulatory Speed (km/h)

Label	Description	50	60	70	80	90
<b>A</b>	Taper Length for Full Lane Closure (m)	60	85	155	180	200
<b>C</b>	Longitudinal Buffer Area (LBA) (m)	(30)	(40)	50	60	75
<b>D</b>	Maximum Distance between Markers (m)	6	9	9	12	12
	Minimum Number of Markers for Taper	5	7	9	11	13
<b>F</b>	Distance between Construction Signs (m)	50	90	120	140	150

**DI-9 Intersection: Right Turn Lane Closed**

**Multi-Lane Divided**

Mobile Operations

Intermittent

**Very Short Duration**

Short Duration

Long Duration

**NOTES**

For further detail on Work Zone components, see [Table A \(Mobile/Intermittent/Very Short, pg. 240\)](#).

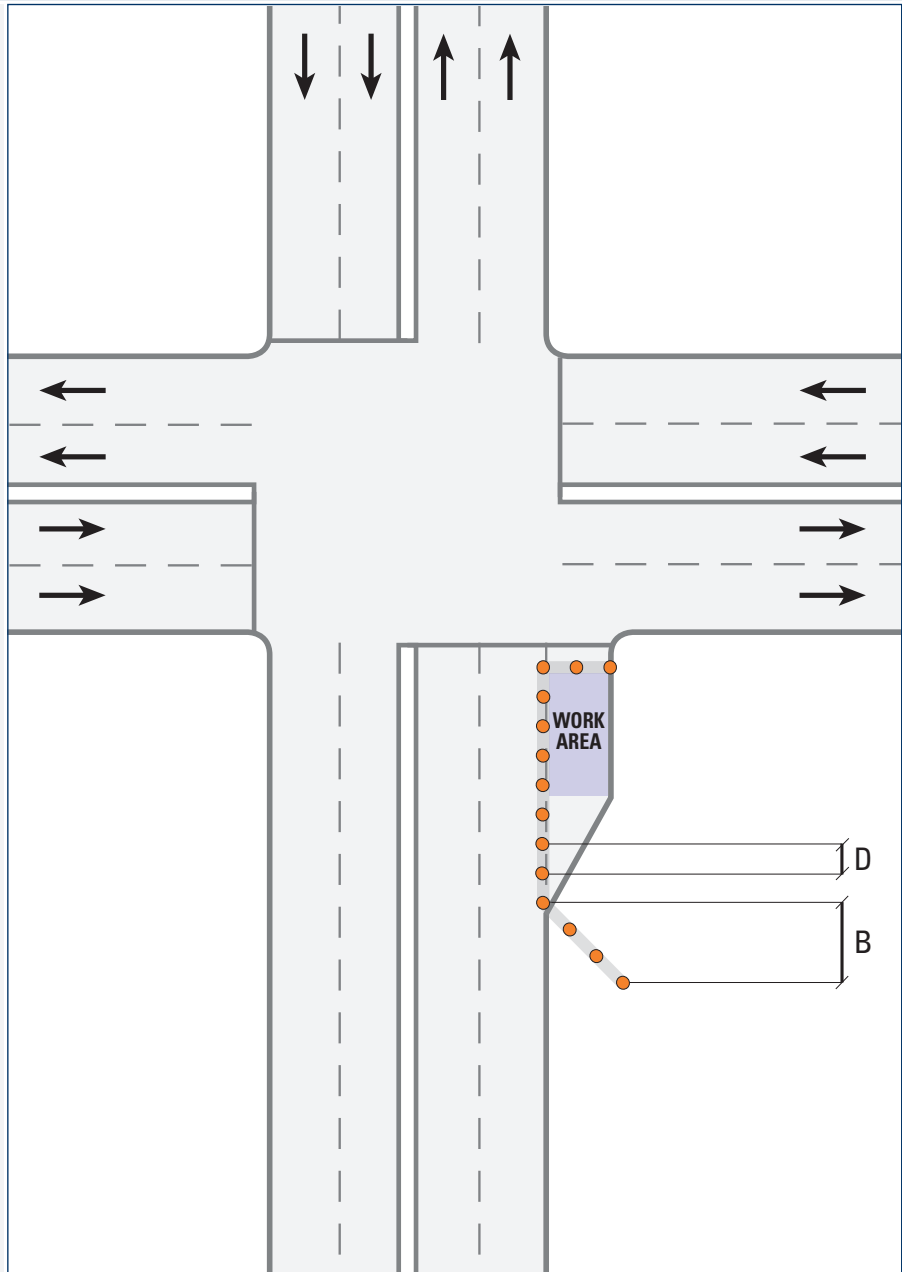

Label	Description	Normal Posted Regulatory Speed (km/h)				
		50	60	70	80	90
<b>B</b>	Shoulder Taper (m)	20	30	35	35	40
<b>D</b>	Maximum Distance between Markers (m)	6	6	9	9	12
	Minimum Number of Markers for Taper	4	5	5	7	8

**DI-10 Intersection: Right Turn Lane Closed**

**Multi-Lane Divided**    Mobile Operations    Intermittent    Very Short Duration    **Short Duration**    Long Duration

**NOTES**

For further detail on Work Zone components, see [Table B \(Short/Long, pg. 241\)](#).

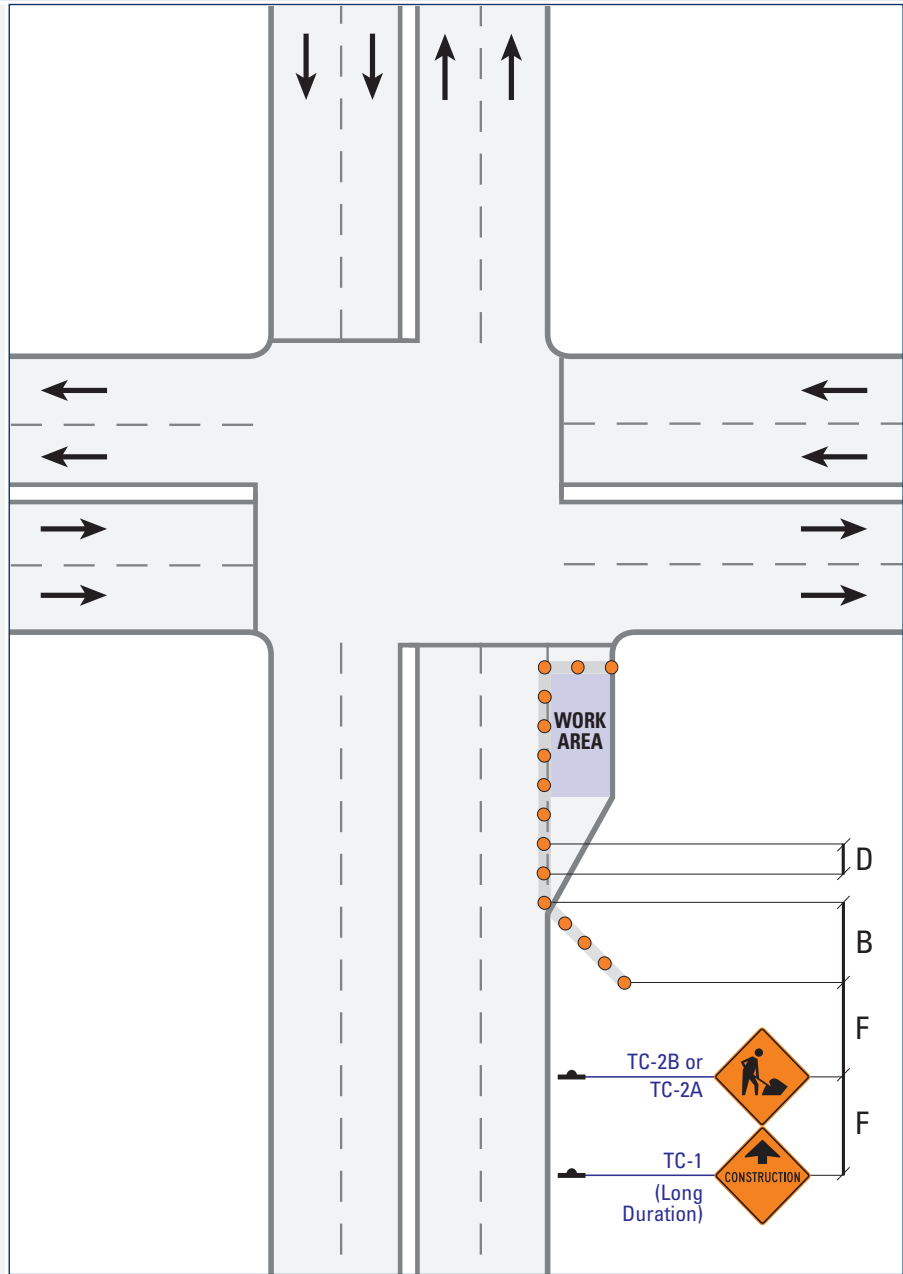

Normal Posted Regulatory Speed (km/h)

Label	Description	Normal Posted Regulatory Speed (km/h)				
		50	60	70	80	90
<b>B</b>	Shoulder Taper (m)	20	30	55	60	70
<b>D</b>	Maximum Distance between Markers (m)	6	9	9	12	12
	Minimum Number of Markers for Taper	5	7	9	11	13
<b>F</b>	Distance between Construction Signs (m)	50	90	120	140	150

**DI-11 Intersection: Left Turn Lane Closed**

**Multi-Lane Divided**

Mobile Operations

Intermittent

**Very Short Duration**

Short Duration

Long Duration

**NOTES**

i) It may be necessary to prohibit left turns.

For further detail on Work Zone components, see [Table A \(Mobile/Intermittent/Very Short, pg. 240\)](#).

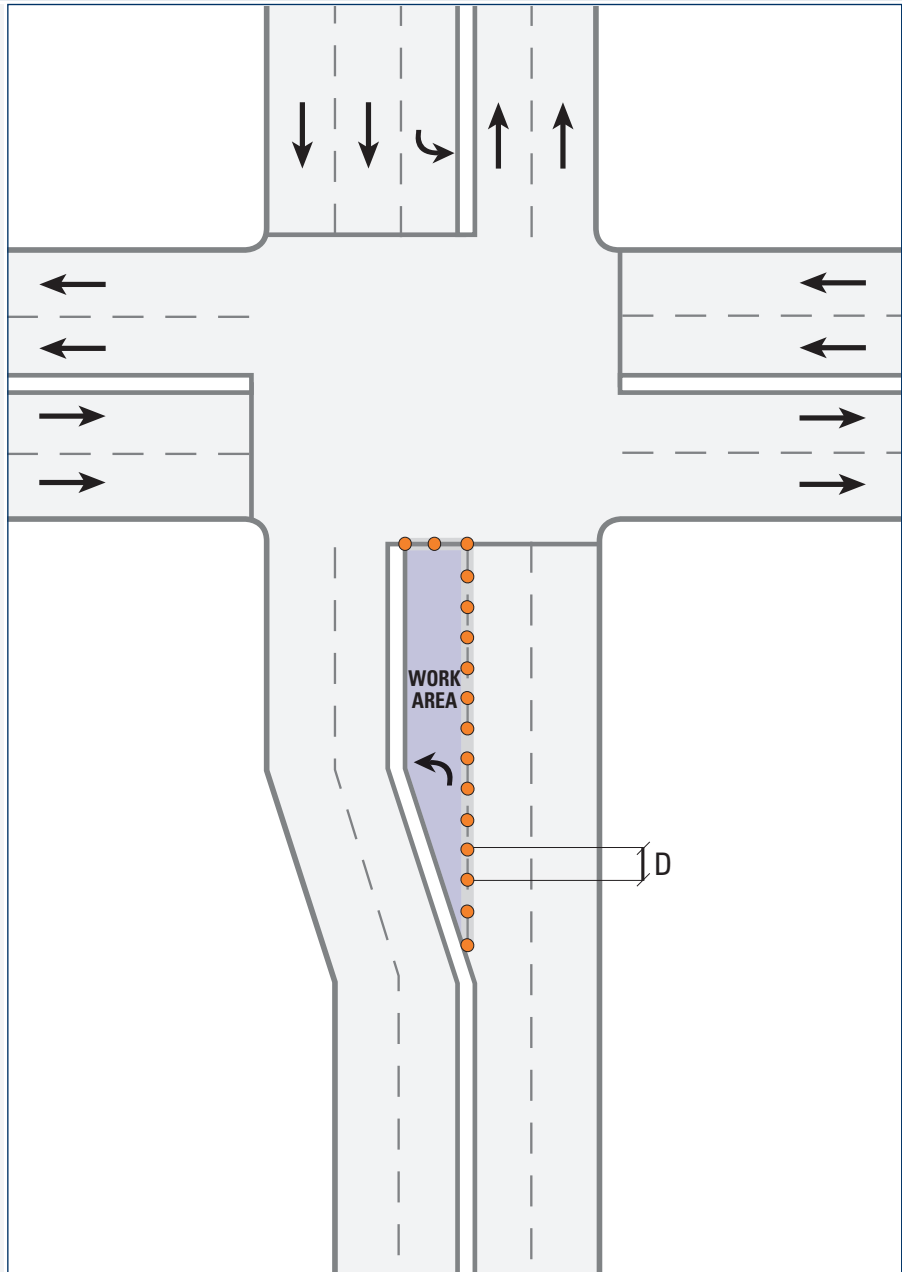

Label	Description	Normal Posted Regulatory Speed (km/h)				
		50	60	70	80	90
<b>D</b>	Maximum Distance between Markers (m)	6	6	9	9	12
	Minimum Number of Markers for Taper	4	5	5	7	8

**DI-12 Intersection: Left Turn Lane Closed**

**Multi-Lane Divided**

Mobile Operations

Intermittent

Very Short Duration

Short Duration

Long Duration

**NOTES**

i) It may be necessary to prohibit left turns.

For further detail on Work Zone components, see [Table B \(Short/Long, pg. 241\)](#).

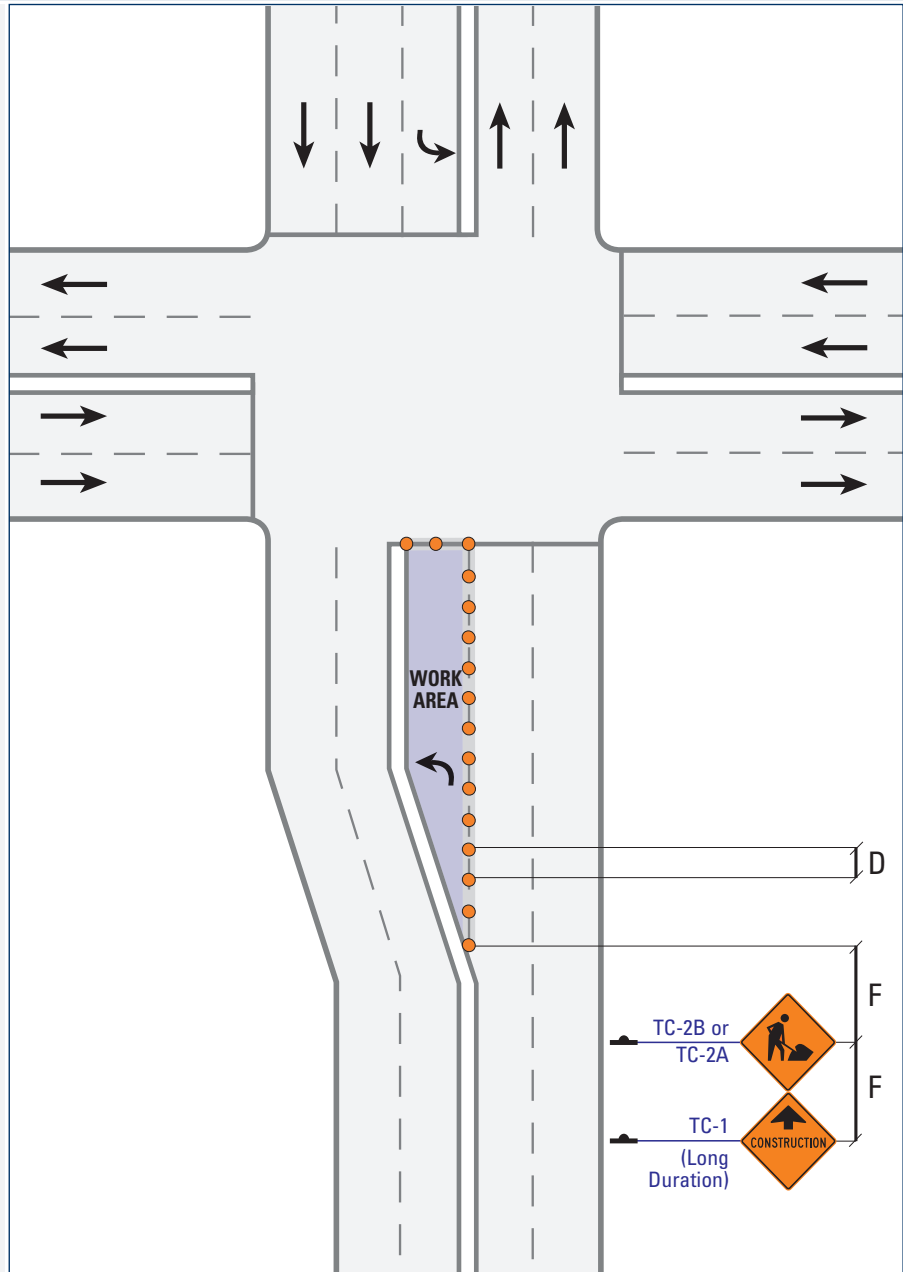

Label	Description	Normal Posted Regulatory Speed (km/h)				
		50	60	70	80	90
<b>D</b>	Maximum Distance between Markers (m)	6	9	9	12	12
	Minimum Number of Markers for Taper	5	7	9	11	13
<b>F</b>	Distance between Construction Signs (m)	50	90	120	140	150

**DI-13 Intersection: Far-Side Lane Closed**

**Multi-Lane Divided**

Mobile Operations

Intermittent

**Very Short Duration**

Short Duration

Long Duration

**NOTES**

- i) Right Lane Closed: mirror image.
- ii) Measures should be taken to make sure on-street parking is not allowed next to the Work Area or Taper.
- iii) It may be necessary to prohibit left turns.

For further detail on Work Zone components, see [Table A \(Mobile/Intermittent/Very Short, pg. 240\)](#).

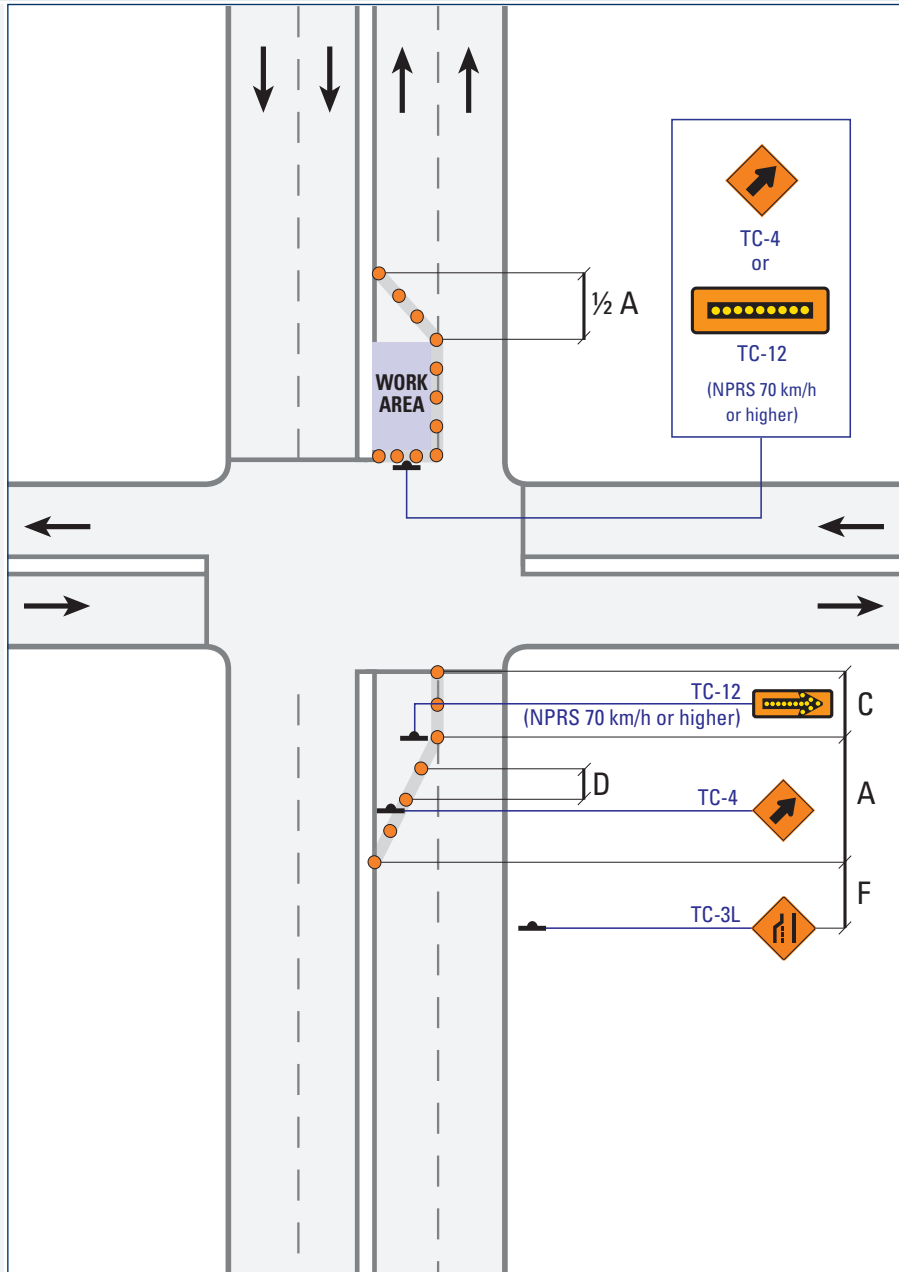

Label	Description	Normal Posted Regulatory Speed (km/h)				
		50	60	70	80	90
<b>A</b>	Taper Length for Full Lane Closure (m)	60	85	100	100	110
<b>C</b>	Longitudinal Buffer Area (LBA) (m)	(30)	(40)	50	60	75
<b>D</b>	Maximum Distance between Markers (m)	6	6	9	9	12
	Minimum Number of Markers for Taper	4	5	5	7	8
<b>F</b>	Distance between Construction Signs (m)	30	30	60	60	80

**DI-14 Intersection: Far-Side Lane Closed**

**Multi-Lane Divided**    Mobile Operations    Intermittent    Very Short Duration    Short Duration    Long Duration

**NOTES**

- i) Right Lane Closed: mirror image.
- ii) Measures should be taken to make sure on-street parking is not allowed next to the Work Area or Taper.
- iii) It may be necessary to prohibit left turns.

For further detail on Work Zone components, see [Table B \(Short/Long, pg. 241\)](#).

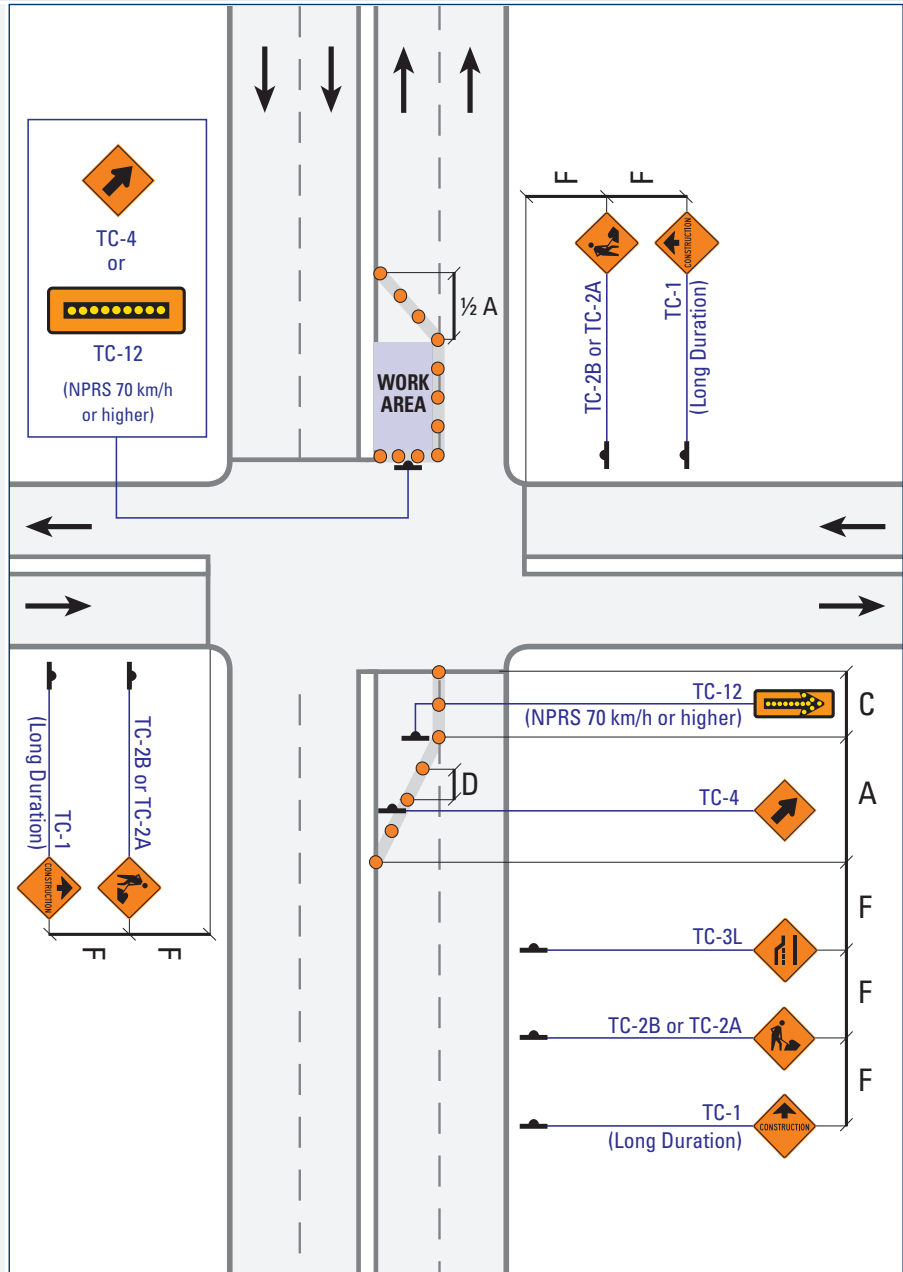

Normal Posted Regulatory Speed (km/h)

Label	Description	50	60	70	80	90
<b>A</b>	Taper Length for Full Lane Closure (m)	60	85	155	180	200
<b>C</b>	Longitudinal Buffer Area (LBA) (m)	(30)	(40)	50	60	75
<b>D</b>	Maximum Distance between Markers (m)	6	9	9	12	12
	Minimum Number of Markers for Taper	5	7	9	11	13
<b>F</b>	Distance between Construction Signs (m)	50	90	120	140	150



**DI-15 Intersection: Lane Adjacent to Right Turn Lane Closed**

**Multi-Lane Divided**    Mobile Operations    Intermittent    Very Short Duration    **Short Duration**    Long Duration

**NOTES**

i) If space permits, use TC-53A or TC-53B to surround the Work Area, otherwise reduce spacing between TC-54.

For further detail on Work Zone components, see [Table B \(Short/Long, pg. 241\)](#).

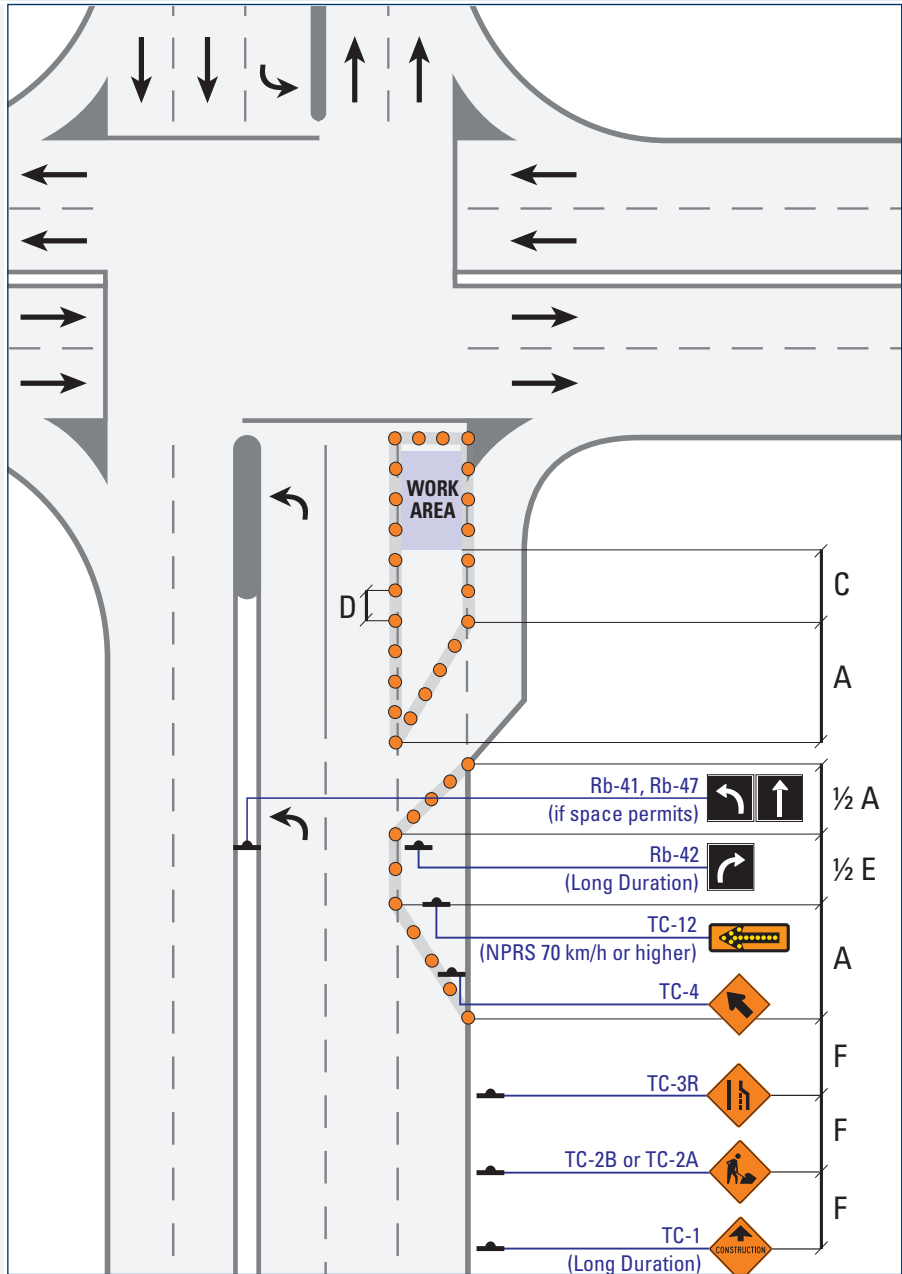

**Normal Posted Regulatory Speed (km/h)**

Label	Description	50	60	70	80	90
<b>A</b>	Taper Length for Full Lane Closure (m)	60	85	155	180	200
<b>C</b>	Longitudinal Buffer Area (LBA) (m)	(30)	(40)	50	60	75
<b>D</b>	Maximum Distance between Markers (m)	6	9	9	12	12
	Minimum Number of Markers for Taper	5	7	9	11	13
<b>E</b>	Minimum Tangent between Tapers (m)	60	85	155	180	200
<b>F</b>	Distance between Construction Signs (m)	50	90	120	140	150

**DI-16 Intersection: Lane Adjacent to Left Turn Lane Closed**

**Multi-Lane Divided** Mobile Operations Intermittent Very Short Duration Short Duration Long Duration

**NOTES**

i) Repeated median signing required for Long Duration only.

ii) If space permits, use TC-53A or TC-53B to surround the Work Area, otherwise reduce spacing between TC-54.

For further detail on Work Zone components, see [Table B \(Short/Long, pg. 241\)](#).

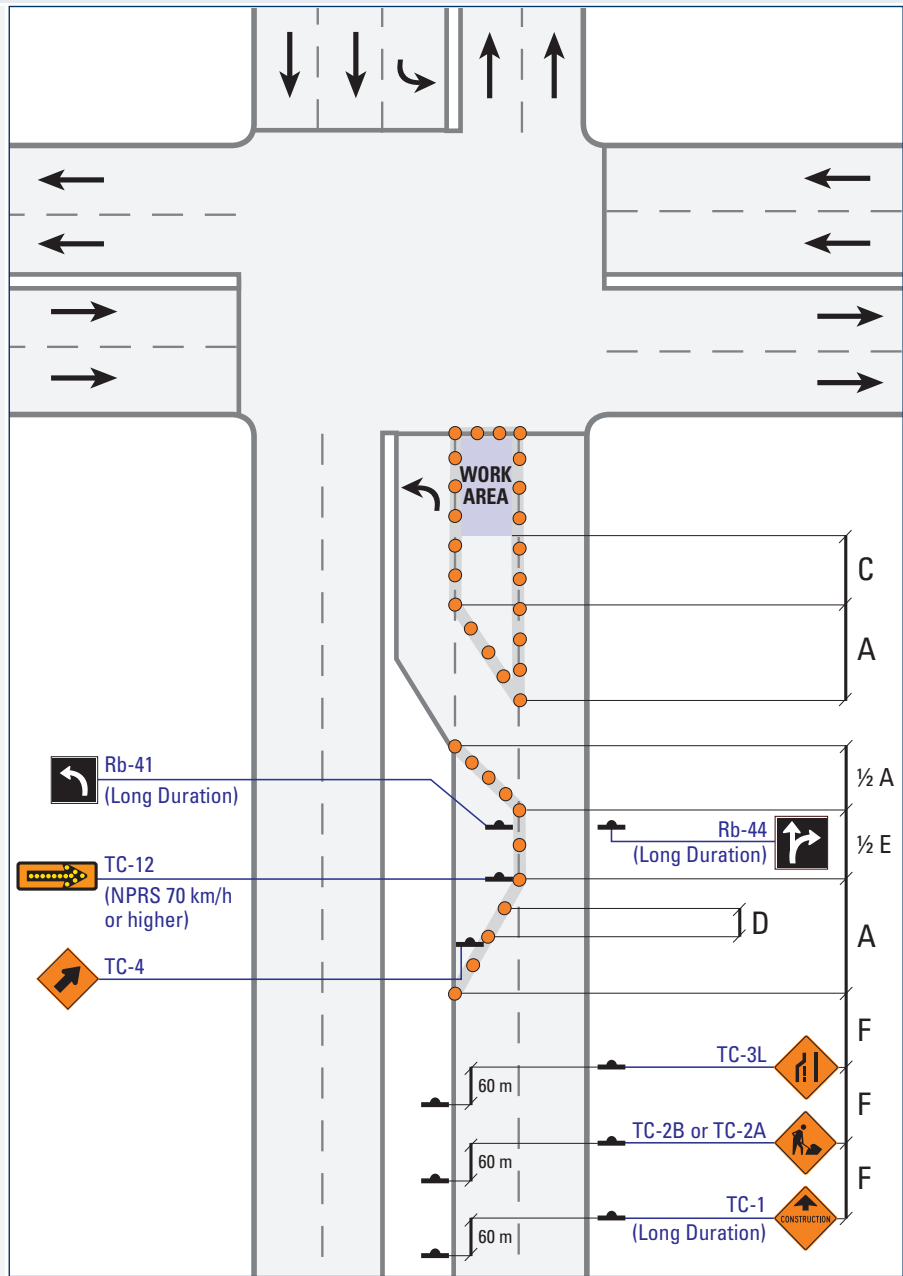

Normal Posted Regulatory Speed (km/h)

Label	Description	50	60	70	80	90
A	Taper Length for Full Lane Closure (m)	60	85	155	180	200
C	Longitudinal Buffer Area (LBA) (m)	(30)	(40)	50	60	75
D	Maximum Distance between Markers (m)	6	9	9	12	12
	Minimum Number of Markers for Taper	5	7	9	11	13
E	Minimum Tangent between Tapers (m)	60	85	155	180	200
F	Distance between Construction Signs (m)	50	90	120	140	150

DI-17

Intersection: Right Turn Lane (Far-Side Right Lane Closed)

Multi-Lane Divided

Mobile Operations

Intermittent

Very Short Duration

Short Duration

Long Duration

NOTES

i) If space permits, use TC-53A or TC-53B to surround the Work Area, otherwise reduce spacing between TC-54.

ii) It may be necessary to prohibit certain turning movements.

iii) It may be necessary to prohibit right turn truck movements.

For further detail on Work Zone components, see [Table B \(Short/Long, pg. 241\)](#).

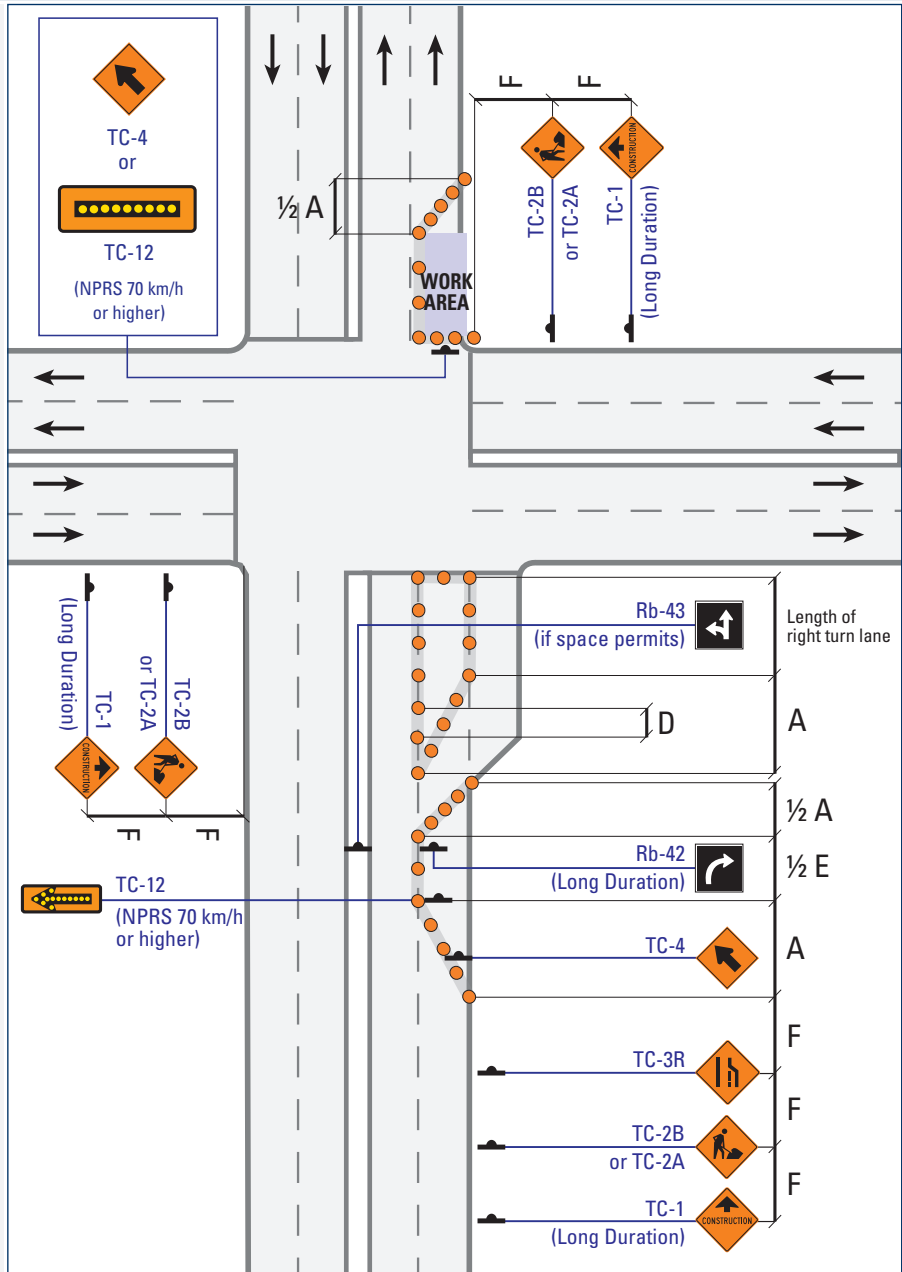

Normal Posted Regulatory Speed (km/h)

Label	Description	50	60	70	80	90
A	Taper Length for Full Lane Closure (m)	60	85	155	180	200
D	Maximum Distance between Markers (m)	6	9	9	12	12
	Minimum Number of Markers for Taper	5	7	9	11	13
E	Minimum Tangent between Tapers (m)	60	85	155	180	200
F	Distance between Construction Signs (m)	50	90	120	140	150

**DI-18**

**Intersection: (Left Turn Lane Open) Far-Side Left Lane Closed**

**Multi-Lane Divided**

Mobile Operations

Intermittent

Very Short Duration

Short Duration

Long Duration

**NOTES**

i) If space permits, use TC-53A or TC-53B to surround the Work Area, otherwise reduce spacing between TC-54.

ii) Repeated median signing required for Long Duration only.

iii) It may be necessary to prohibit right turn truck movements.

For further detail on Work Zone components, see [Table B \(Short/Long, pg. 241\)](#).

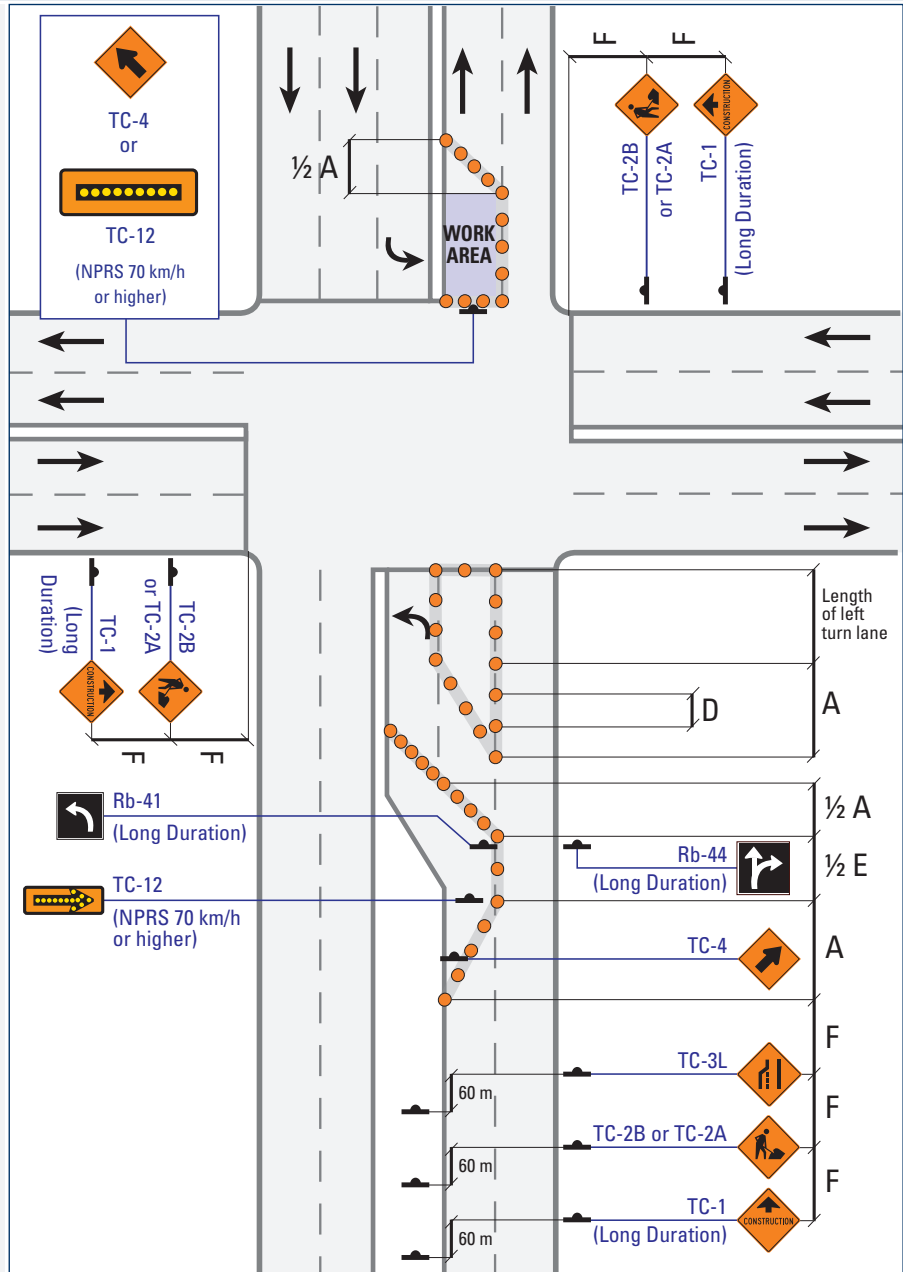

Normal Posted Regulatory Speed (km/h)

Label	Description	50	60	70	80	90
<b>A</b>	Taper Length for Full Lane Closure (m)	60	85	155	180	200
<b>D</b>	Maximum Distance between Markers (m)	6	9	9	12	12
	Minimum Number of Markers for Taper	5	7	9	11	13
<b>E</b>	Minimum Tangent between Tapers (m)	60	85	155	180	200
<b>F</b>	Distance between Construction Signs (m)	50	90	120	140	150

**DI-19 Intersection: Right Turn Lane and Adjacent Through Lanes Closed**

**Multi-Lane Divided**

Mobile Operations

Intermittent

**Very Short Duration**

Short Duration

Long Duration

**NOTES**

i) If space permits, use TC-53A or TC-53B to surround the Work Area, otherwise reduce spacing between TC-54.

For further detail on Work Zone components, see [Table A \(Mobile/Intermittent/Very Short, pg. 240\)](#).

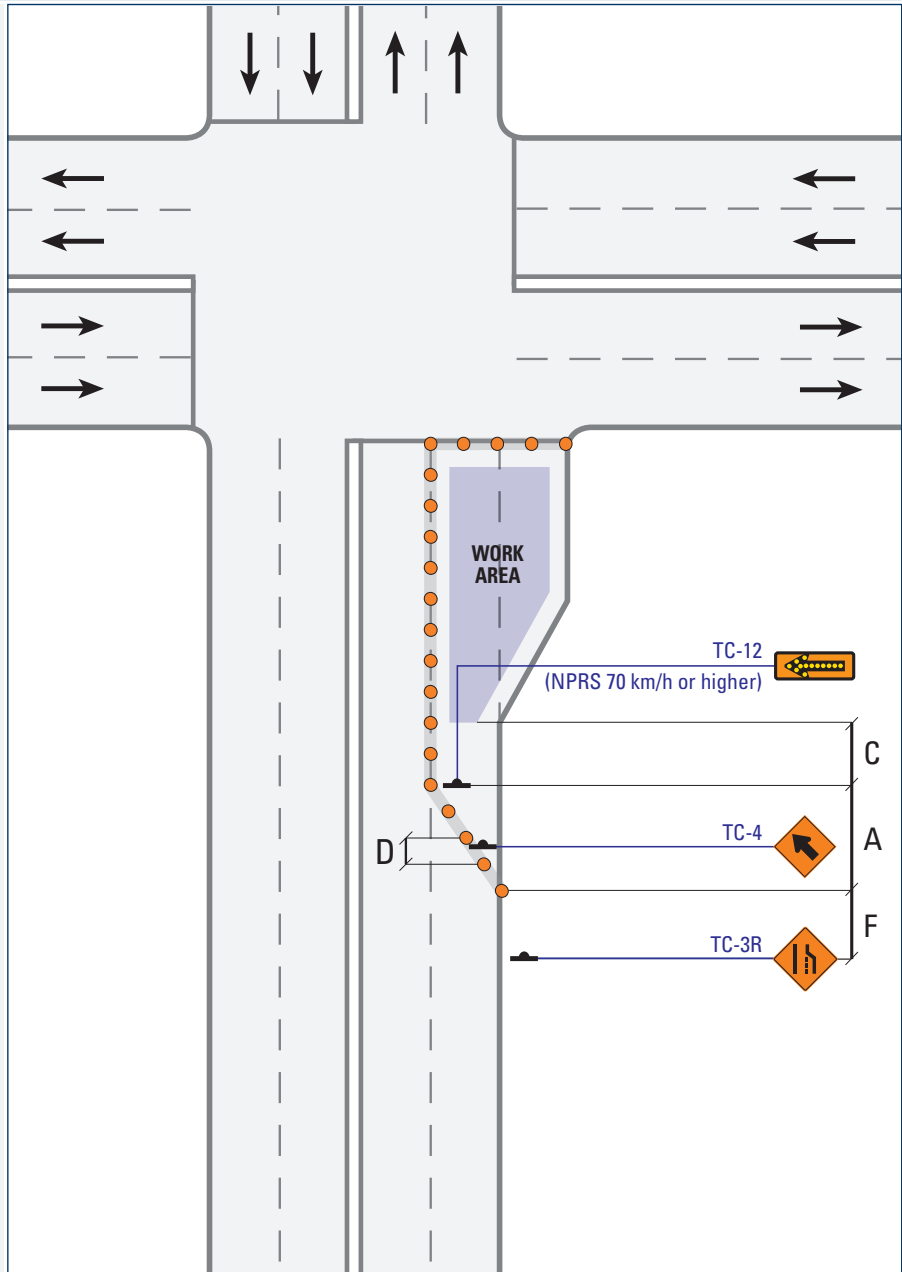

Label	Description	Normal Posted Regulatory Speed (km/h)				
		50	60	70	80	90
<b>A</b>	Taper Length for Full Lane Closure (m)	60	85	100	100	110
<b>C</b>	Longitudinal Buffer Area (LBA) (m)	(30)	(40)	50	60	75
<b>D</b>	Maximum Distance between Markers (m)	6	6	9	9	12
	Minimum Number of Markers for Taper	4	5	5	7	8
<b>F</b>	Distance between Construction Signs (m)	30	30	60	60	80

**DI-20**

**Intersection: Right Turn Lane and Adjacent Through Lanes Closed**

**Multi-Lane Divided**

Mobile Operations

Intermittent

Very Short Duration

Short Duration

Long Duration

**NOTES**

i) If space permits, use TC-53A or TC-53B to surround the Work Area, otherwise reduce spacing between TC-54.

For further detail on Work Zone components, see [Table B \(Short/Long, pg. 241\)](#).

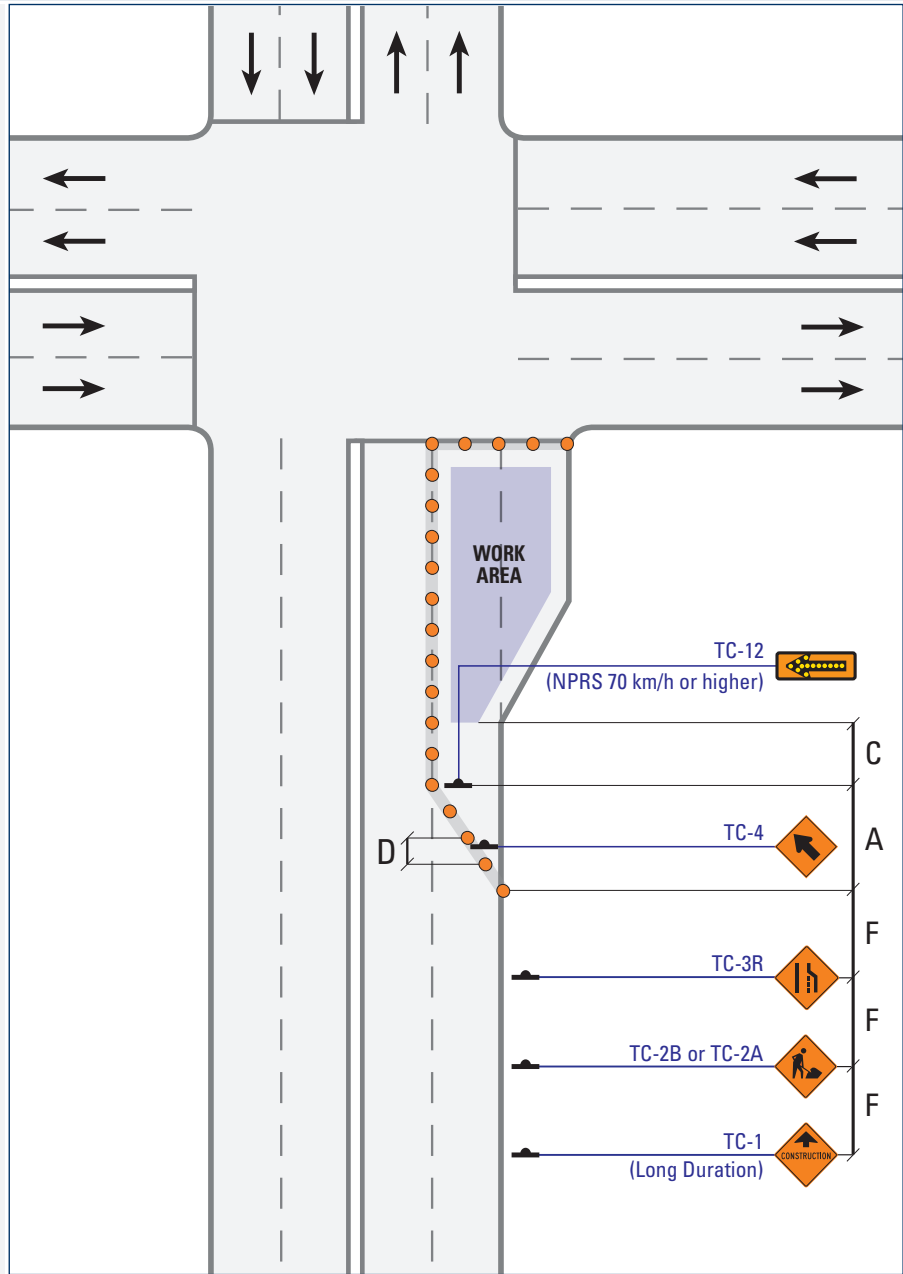

Normal Posted Regulatory Speed (km/h)

Label	Description	50	60	70	80	90
<b>A</b>	Taper Length for Full Lane Closure (m)	60	85	155	180	200
<b>C</b>	Longitudinal Buffer Area (LBA) (m)	(30)	(40)	50	60	75
<b>D</b>	Maximum Distance between Markers (m)	6	9	9	12	12
	Minimum Number of Markers for Taper	5	7	9	11	13
<b>F</b>	Distance between Construction Signs (m)	50	90	120	140	150

**DI-21 Intersection: Left Turn Adjacent Through Lanes Closed**

**Multi-Lane Divided**

Mobile Operations

Intermittent

**Very Short Duration**

Short Duration

Long Duration

**NOTES**

i) If space permits, use TC-53A or TC-53B to surround the Work Area, otherwise reduce spacing between TC-54.

ii) It may be necessary to prohibit left turns in the direction reduced to one lane.

For further detail on Work Zone components, see [Table A \(Mobile/Intermittent/Very Short, pg. 240\)](#).

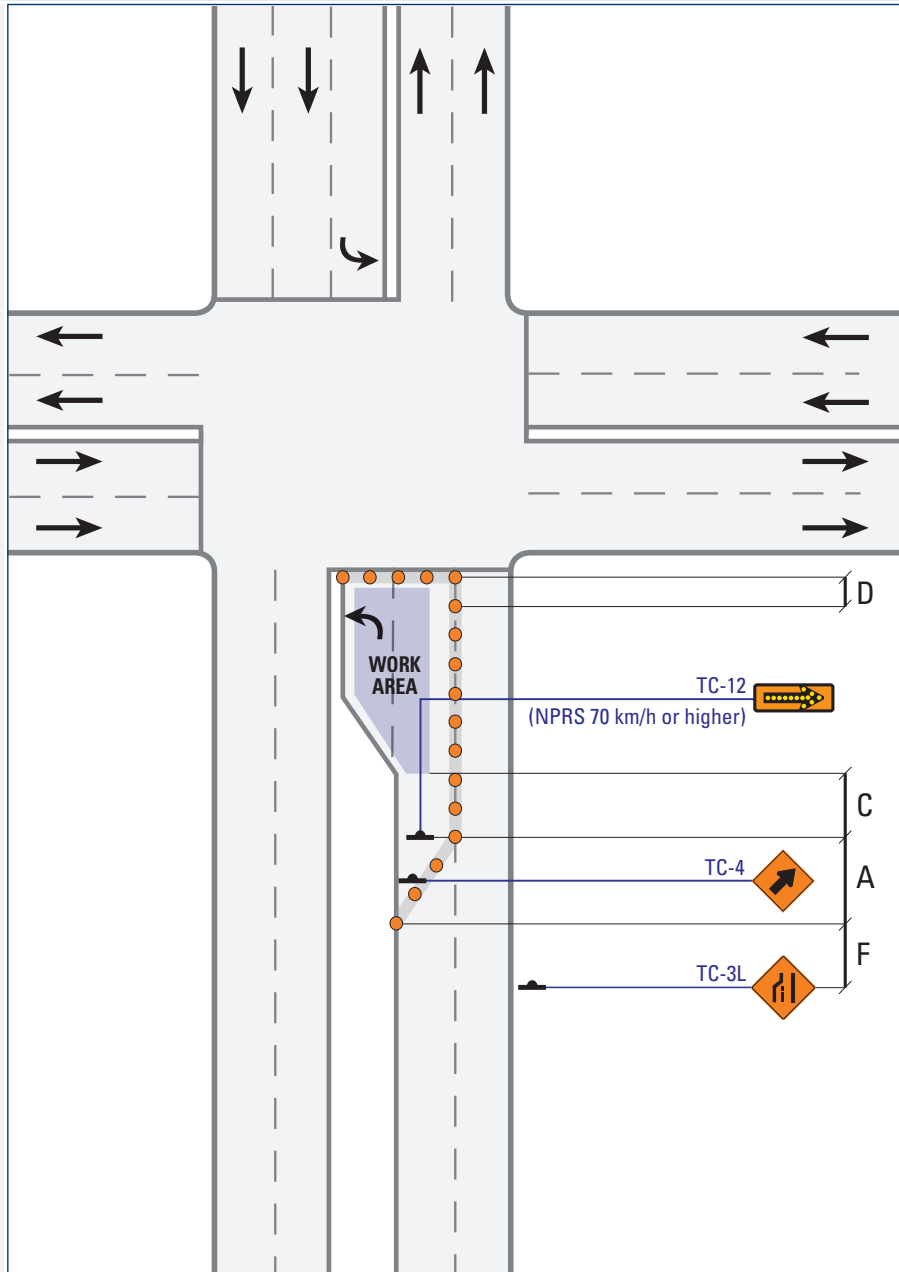

Label	Description	Normal Posted Regulatory Speed (km/h)				
		50	60	70	80	90
<b>A</b>	Taper Length for Full Lane Closure (m)	60	85	100	100	110
<b>C</b>	Longitudinal Buffer Area (LBA) (m)	(30)	(40)	50	60	75
<b>D</b>	Maximum Distance between Markers (m)	6	6	9	9	12
	Minimum Number of Markers for Taper	4	5	5	7	8
<b>F</b>	Distance between Construction Signs (m)	30	30	60	60	80

**DI-22 Intersection: Left Turn Adjacent Through Lanes Closed**

**Multi-Lane Divided** Mobile Operations Intermittent Very Short Duration **Short Duration** Long Duration

**NOTES**

- i) Repeated median signing required for Long Duration only.
- ii) If space permits, use TC-53A or TC-53B to surround the Work Area, otherwise reduce spacing between TC-54.
- iii) It may be necessary to prohibit left turns in the direction reduced to one lane.

For further detail on Work Zone components, see [Table B \(Short/Long, pg. 241\)](#).

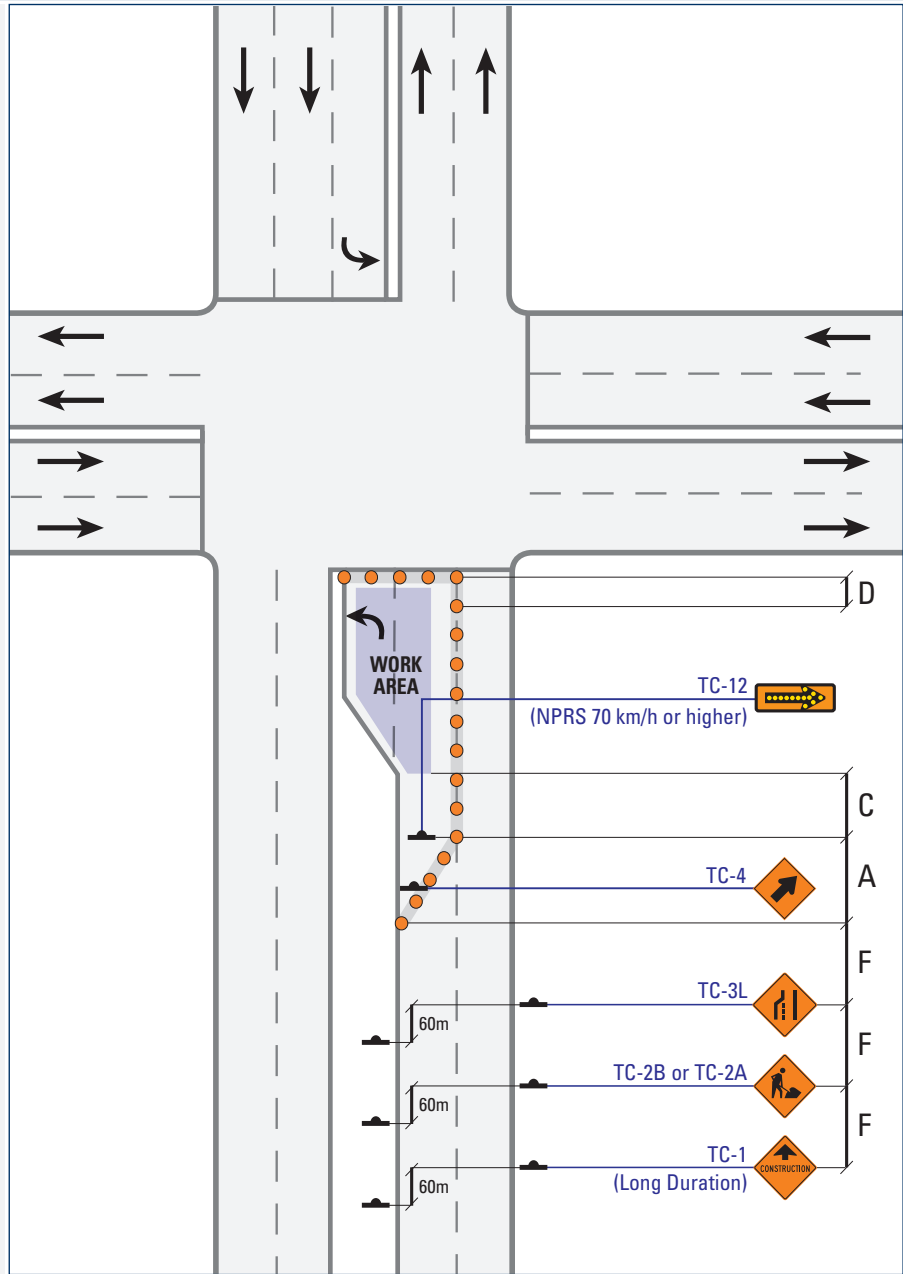

Normal Posted Regulatory Speed (km/h)

Label	Description	50	60	70	80	90
<b>A</b>	Taper Length for Full Lane Closure (m)	60	85	155	180	200
<b>C</b>	Longitudinal Buffer Area (LBA) (m)	(30)	(40)	50	60	75
<b>D</b>	Maximum Distance between Markers (m)	6	9	9	12	12
	Minimum Number of Markers for Taper	5	7	9	11	13
<b>F</b>	Distance between Construction Signs (m)	50	90	120	140	150



**DI-23 Work in Intersection: Right Lane Closed**

**Multi-Lane Divided**

Mobile Operations    Intermittent    Very Short Duration    **Short Duration**    Long Duration

**NOTES**

i) If space permits, use TC-53A or TC-53B to surround the Work Area, otherwise reduce spacing between TC-54.

ii) It may be necessary to prohibit certain turning movements.

iii) Flashing Amber Light above TC-7 must not be used at intersections with active signals.

\*The TC-4 sign must be installed at or just beyond the beginning of a lane closure taper.

For further detail on Work Zone components, see [Table B \(Short/Long, pg. 241\)](#).

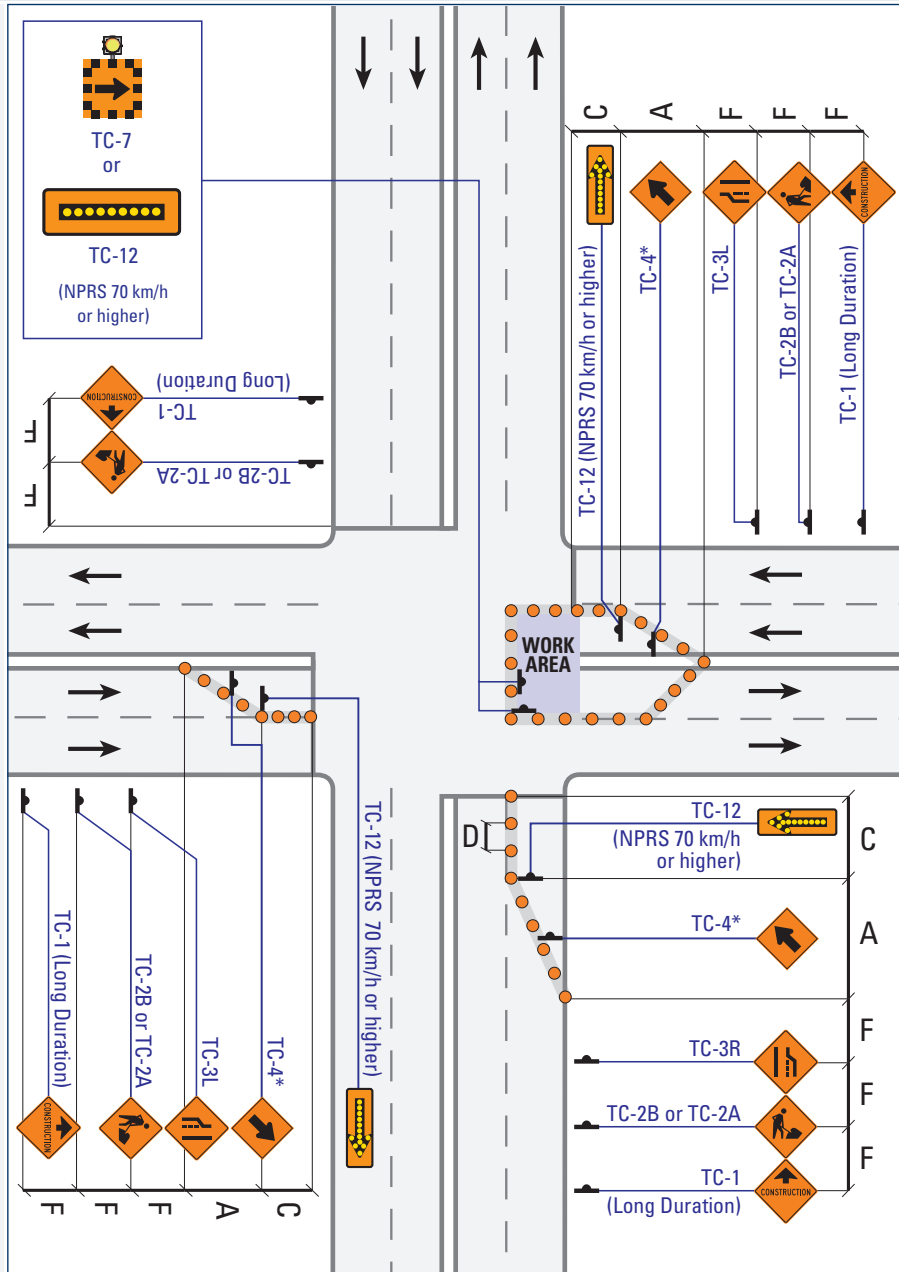

**Normal Posted Regulatory Speed (km/h)**

Label	Description	50	60	70	80	90
<b>A</b>	Taper Length for Full Lane Closure (m)	60	85	155	180	200
<b>C</b>	Longitudinal Buffer Area (LBA) (m)	(30)	(40)	50	60	75
<b>D</b>	Maximum Distance between Markers (m)	6	9	9	12	12
	Minimum Number of Markers for Taper	5	7	9	11	13
<b>F</b>	Distance between Construction Signs (m)	50	90	120	140	150

**DI-24 Work in Intersection: Left Lane Closed**

**Multi-Lane Divided** Mobile Operations Intermittent Very Short Duration **Short Duration** Long Duration

**NOTES**

i) If space permits, use TC-53A or TC-53B to surround the Work Area, otherwise reduce spacing between TC-54.

ii) It may be necessary to prohibit additional turning movements.

iii) Flashing Amber Light above TC-7 must not be used at intersections with active signals.

iv) See DS-17 "Route Detour", for applicable layout.

\*The TC-4 sign must be installed at or just beyond the beginning of a lane closure taper.

For further detail on Work Zone components, see [Table B \(Short/Long, pg. 241\)](#).

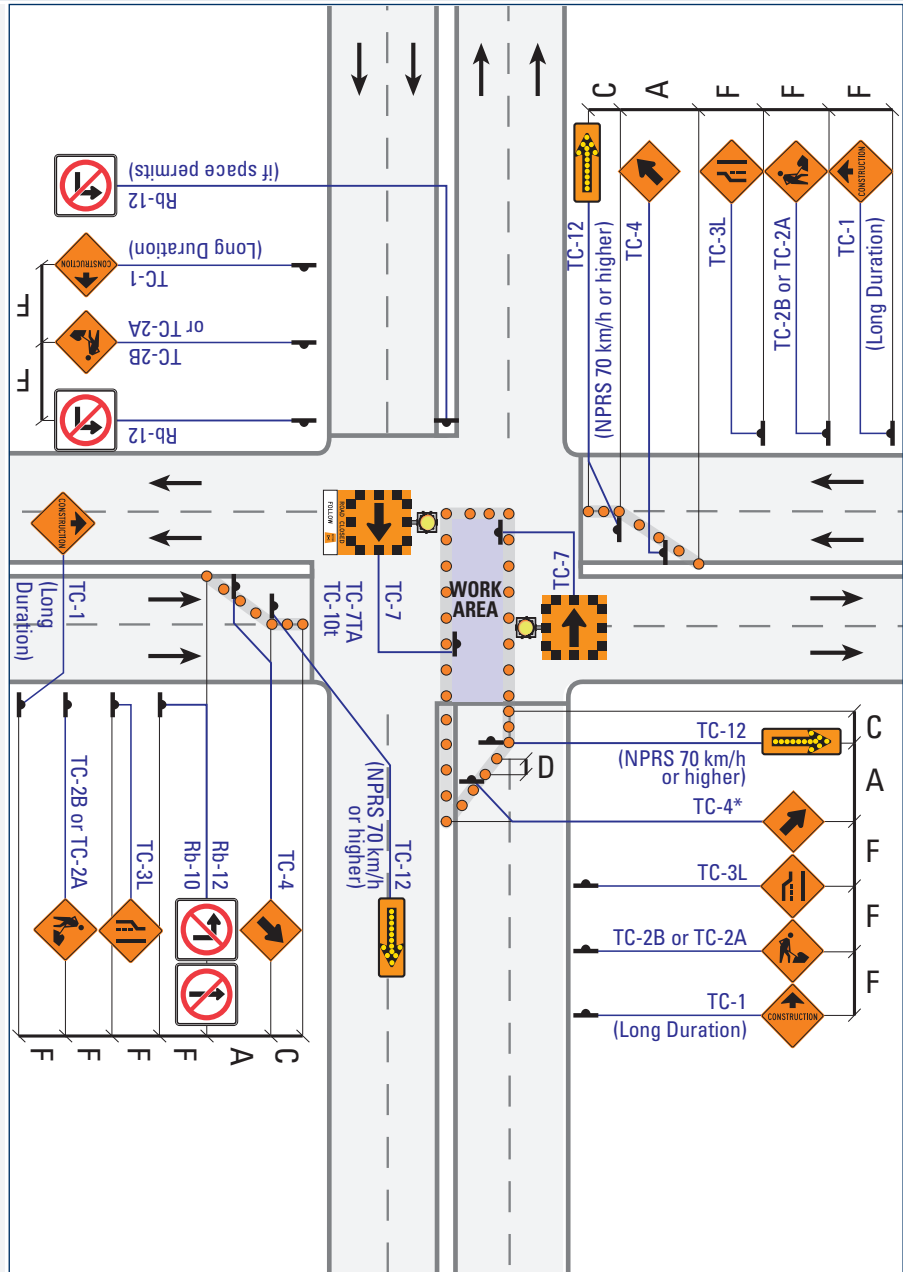

Normal Posted Regulatory Speed (km/h)

Label	Description	50	60	70	80	90
<b>A</b>	Taper Length for Full Lane Closure (m)	60	85	155	180	200
<b>C</b>	Longitudinal Buffer Area (LBA) (m)	(30)	(40)	50	60	75
<b>D</b>	Maximum Distance between Markers (m)	6	9	9	12	12
	Minimum Number of Markers for Taper	5	7	9	11	13
<b>F</b>	Distance between Construction Signs (m)	50	90	120	140	150

**DI-25 Work in Intersection: Road Closed (Detour) - Option 1**

**Multi-Lane Divided**

Mobile Operations

Intermittent

Very Short Duration

Short Duration

Long Duration

**NOTES**

i) If space permits, use TC-53A or TC-53B to surround the Work Area, otherwise reduce spacing between TC-54.

ii) Flashing Amber Light above TC-7 must not be used at intersections with active signals.

iii) See DS-17 "Route Detour", for applicable layout.

For further detail on Work Zone components, see [Table B \(Short/Long, pg. 241\)](#).

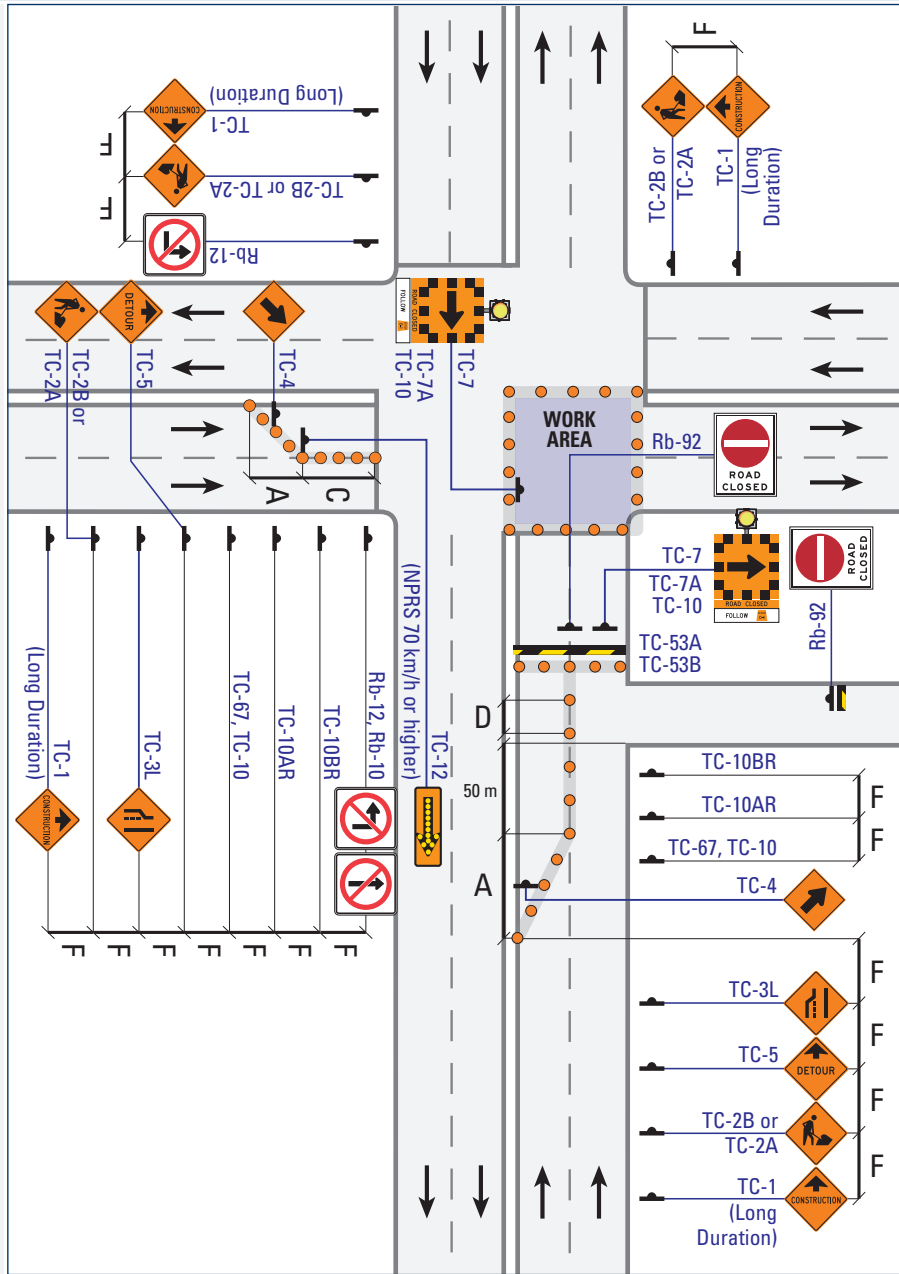

**Normal Posted Regulatory Speed (km/h)**

Label	Description	50	60	70	80	90
<b>A</b>	Taper Length for Full Lane Closure (m)	60	85	155	180	200
<b>C</b>	Longitudinal Buffer Area (LBA) (m)	(30)	(40)	50	60	75
<b>D</b>	Maximum Distance between Markers (m)	6	9	9	12	12
	Minimum Number of Markers for Taper	5	7	9	11	13
<b>F</b>	Distance between Construction Signs (m)	50	90	120	140	150

**DI-26 Work in Intersection: Two Lanes Closed - Option 2**

**Multi-Lane Divided** Mobile Operations Intermittent Very Short Duration Short Duration Long Duration

**NOTES**

i) If space permits, use TC-53A or TC-53B to surround the Work Area, otherwise reduce spacing between TC-54.

ii) It may be necessary to prohibit certain turning movements.

iii) Flashing Amber Light above TC-7 must not be used at intersections with active signals.

iv) See DS-17 "Route Detour", for applicable layout.

**The median elevation must match the highway elevation. Remove necessary portion of the raised median. If a traffic signal pole is present, it must be relocated with a temporary traffic signal.**

\*The TC-4 sign must be installed at or just beyond the beginning of a lane closure taper.

For further detail on Work Zone components, see Table B (Short/Long, pg. 241).

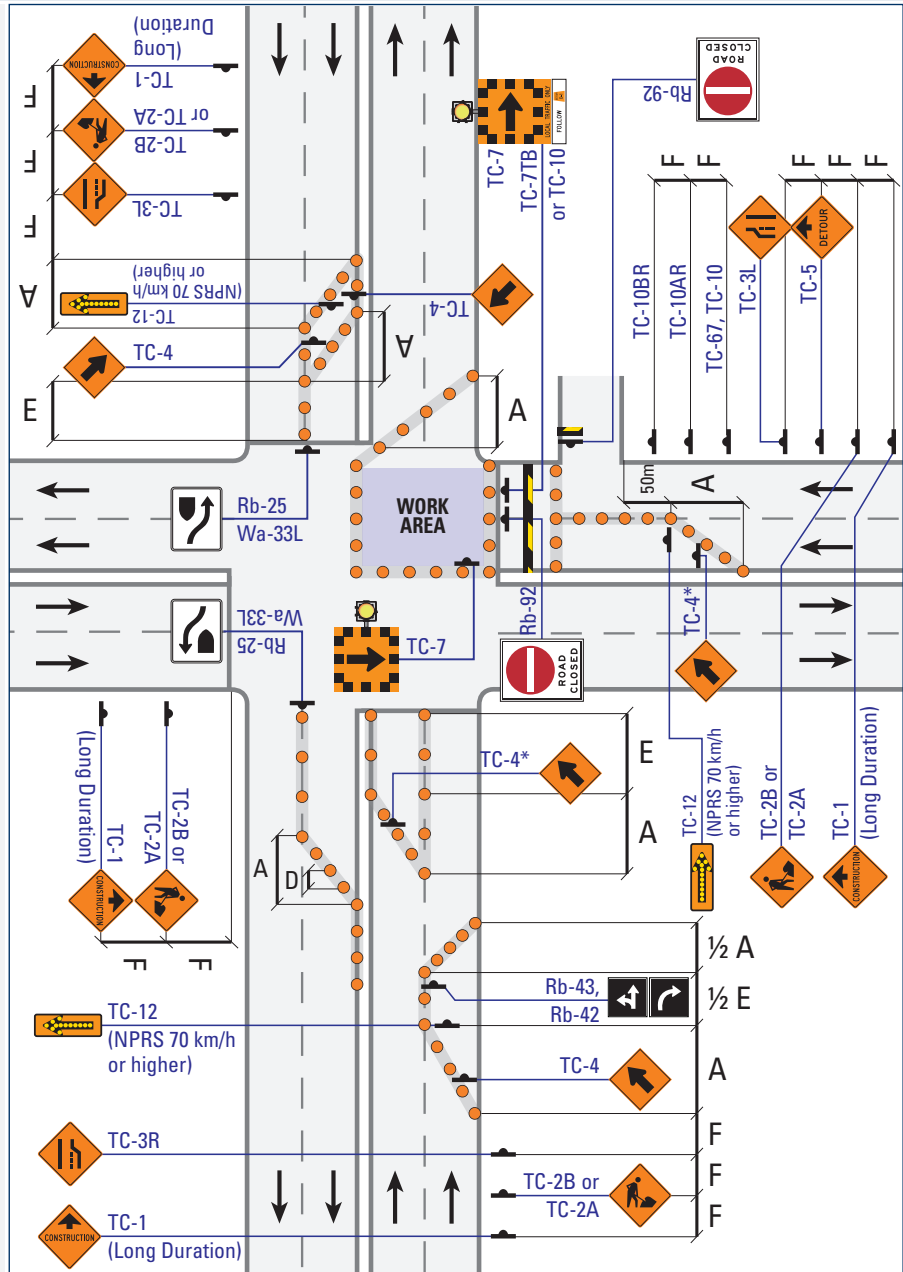

Normal Posted Regulatory Speed (km/h)

Label	Description	50	60	70	80	90
A	Taper Length for Full Lane Closure (m)	60	85	155	180	200
D	Maximum Distance between Markers (m)	6	9	9	12	12
	Minimum Number of Markers for Taper	5	7	9	11	13
E	Minimum Tangent between Tapers (m)	60	85	155	180	200
F	Distance between Construction Signs (m)	50	90	120	140	150

**DI-27**

**Pedestrian Accomodation: Intersection Sidewalk Detour Onto Roadway**

**Multi-Lane Divided**

Mobile Operations

Intermittent

Very Short Duration

**Short Duration**

Long Duration

**NOTES**

- i) For Sidewalk Closures of Long Duration, a boardwalk and railing should be provided instead of Pedestrian Barricades.
- ii) Minimum width of the temporary walkway is 1.2 m.
- iii) AODA-compliant ramps are required if the curb is raised.

For further detail on Work Zone components, see [Table B \(Short/Long, pg. 241\)](#).

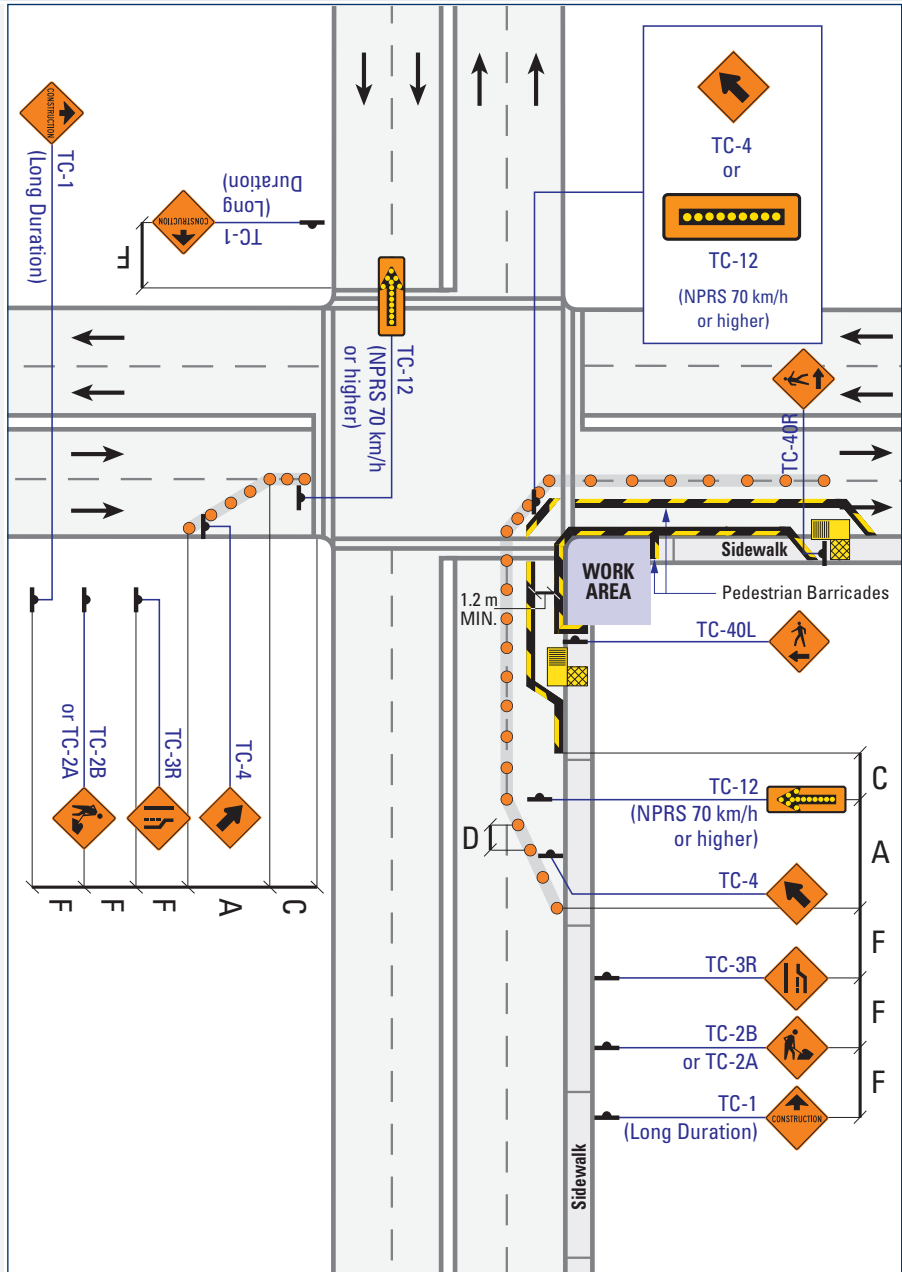

Label	Description	Normal Posted Regulatory Speed (km/h)				
		50	60	70	80	90
<b>A</b>	Taper Length for Full Lane Closure (m)	60	85	155	180	200
<b>C</b>	Longitudinal Buffer Area (LBA) (m)	(30)	(40)	50	60	75
<b>D</b>	Maximum Distance between Markers (m)	6	9	9	12	12
	Minimum Number of Markers for Taper	5	7	9	11	13
<b>F</b>	Distance between Construction Signs (m)	50	90	120	140	150

DI-28

**Pedestrian Detour: Crosswalk Closure**

Multi-Lane Divided

Mobile Operations

Intermittent

Very Short Duration

Short Duration

Long Duration

NOTES

i) Supplementary layout. This layout shows pedestrian signage only and shall be used in conjunction with other appropriate layouts.

ii) See DS-17 & DS-18 for required signage for vehicle Detour.

For further detail on Work Zone components, see [Table B \(Short/Long, pg. 241\)](#).

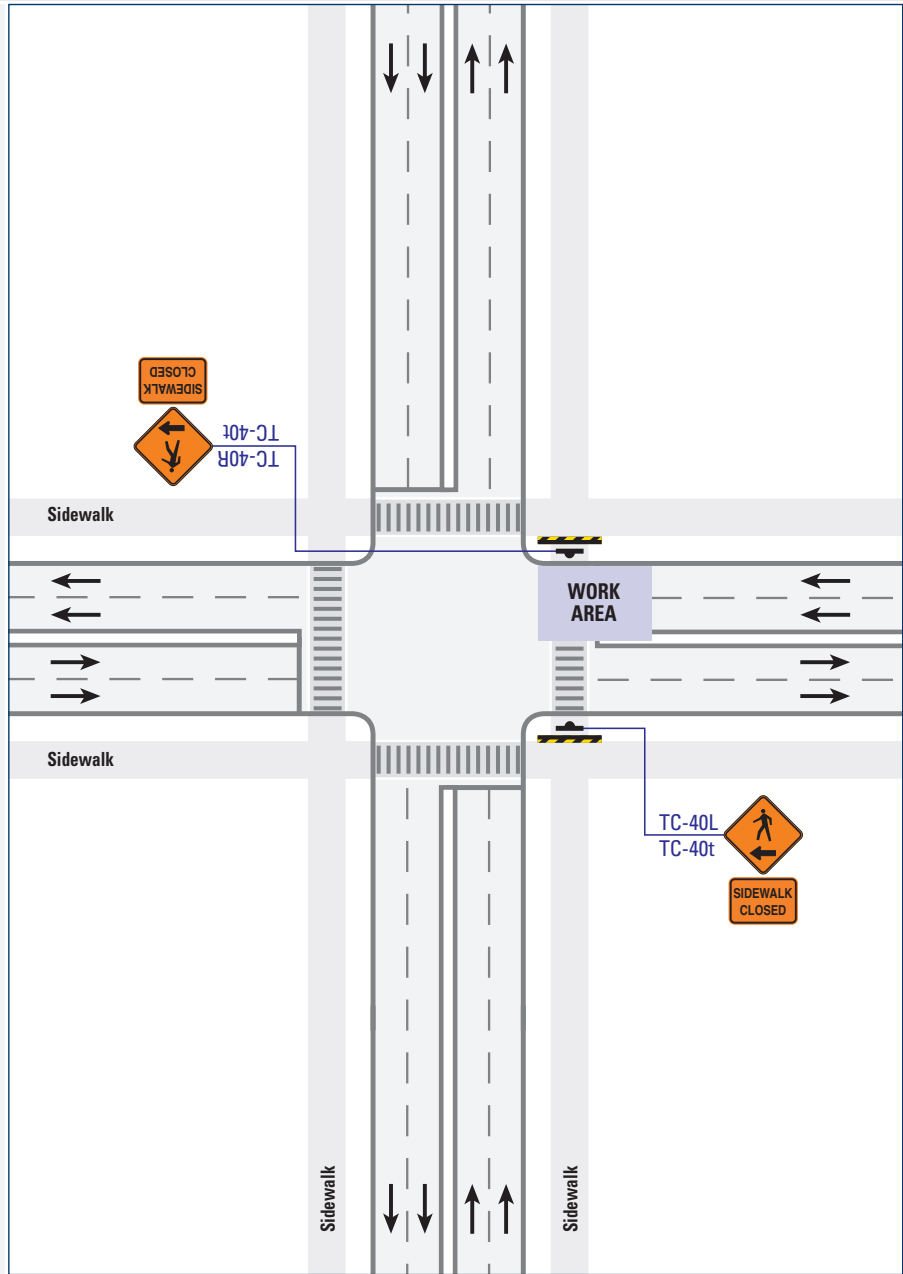

**DI-29 Pedestrian Detour: Crosswalk and Sidewalk Closure**

**Multi-Lane Divided**

Mobile Operations

Intermittent

Very Short Duration

**Short Duration**

Long Duration

**NOTES**

i) TC-40L/R Pedestrian Direction sign must be placed at the nearest upstream controlled pedestrian crossing (traffic signal of Pedestrian Crossover) in each direction.

For further detail on Work Zone components, see [Table B \(Short/Long, pg. 241\)](#).

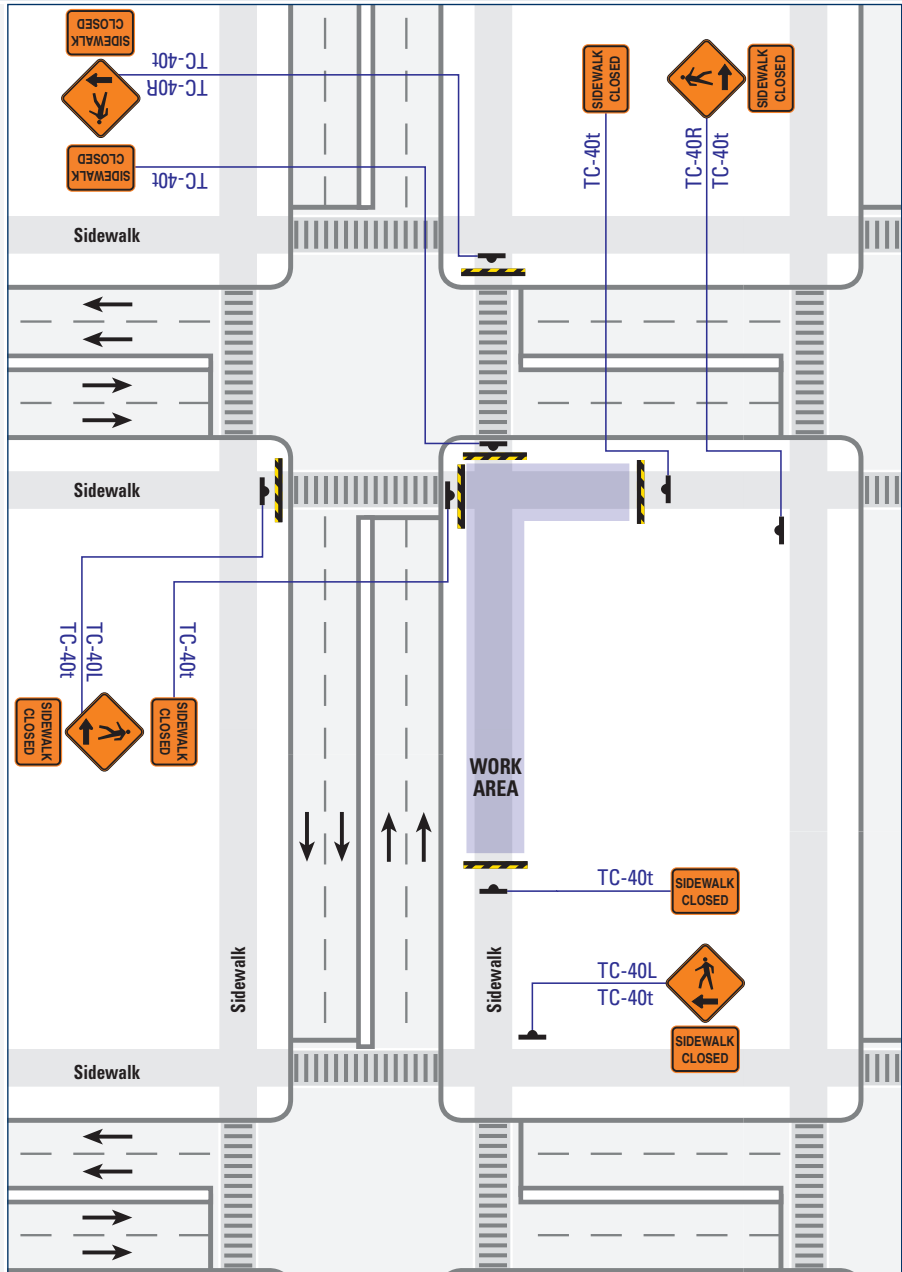

DI-30

Cyclist: Detour

Multi-Lane Divided

Mobile Operations

Intermittent

Very Short Duration

Short Duration

Long Duration

NOTES

Shared lane only to be used if considered by OTM Book 18 or MTO Bikeways Design Manual, Desirable Cycling Facility Nomograph. Otherwise, cycling Detour should be provided.

For further detail on Work Zone components, see Table B (Short/Long, pg. 241).

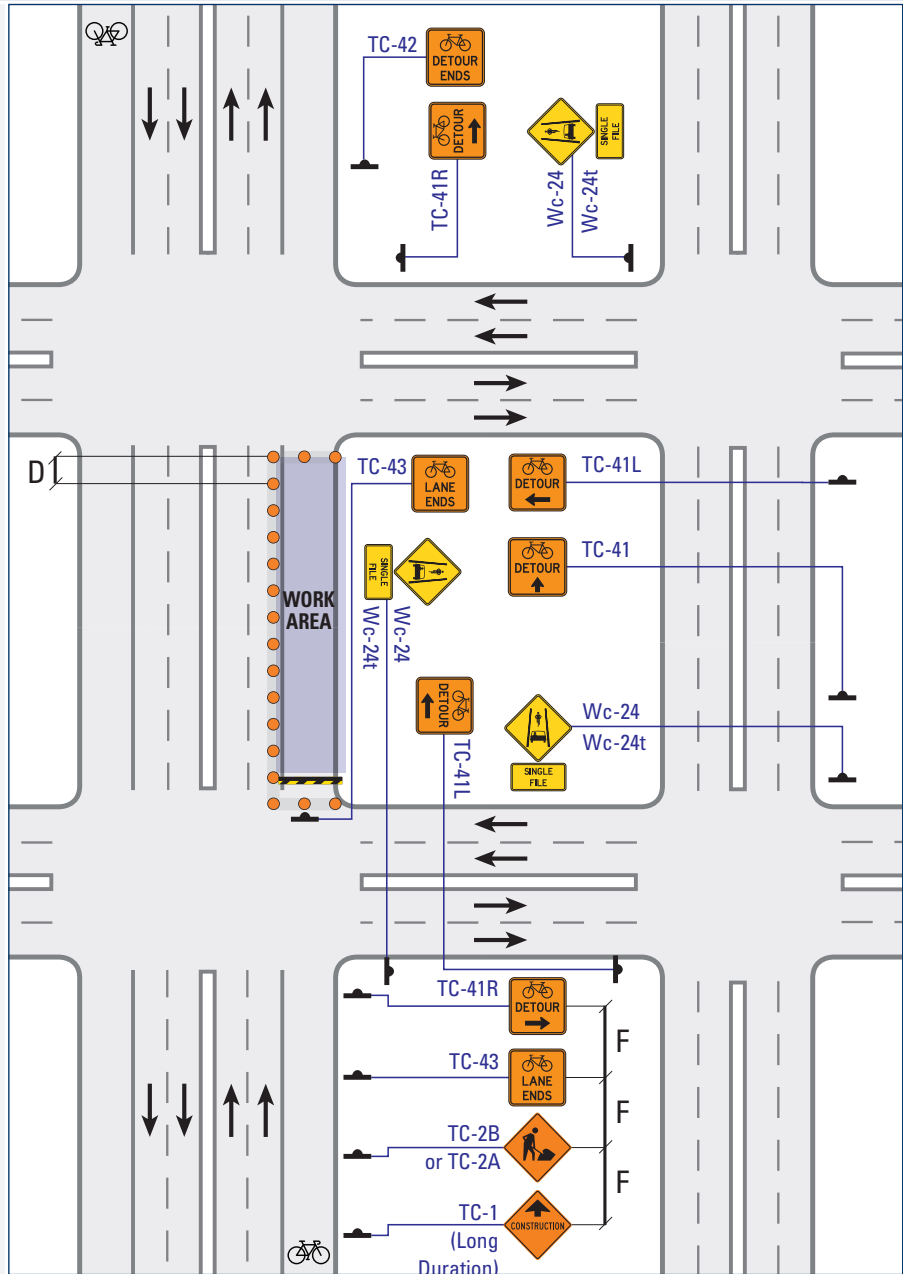

Normal Posted Regulatory Speed (km/h)

Label	Description	50	60	70	80	90
D	Maximum Distance between Markers (m)	6	9	9	12	12
F	Distance between Construction Signs (m)	50	90	120	140	150



DI-31

**Bicycle Lane Closed: Dismount and Walk**

Multi-Lane Divided

Mobile Operations

Intermittent

Very Short Duration

Short Duration

Long Duration

NOTES

i) Supplementary layout. This layout shows cyclist signage only and shall be used in conjunction with other appropriate layouts.

ii) See DS-17 & DS-18 for required signage for vehicle Detour.

iii) Ramps must be AODA-compliant.

For further detail on Work Zone components, see [Table B \(Short/Long, pg. 241\)](#).

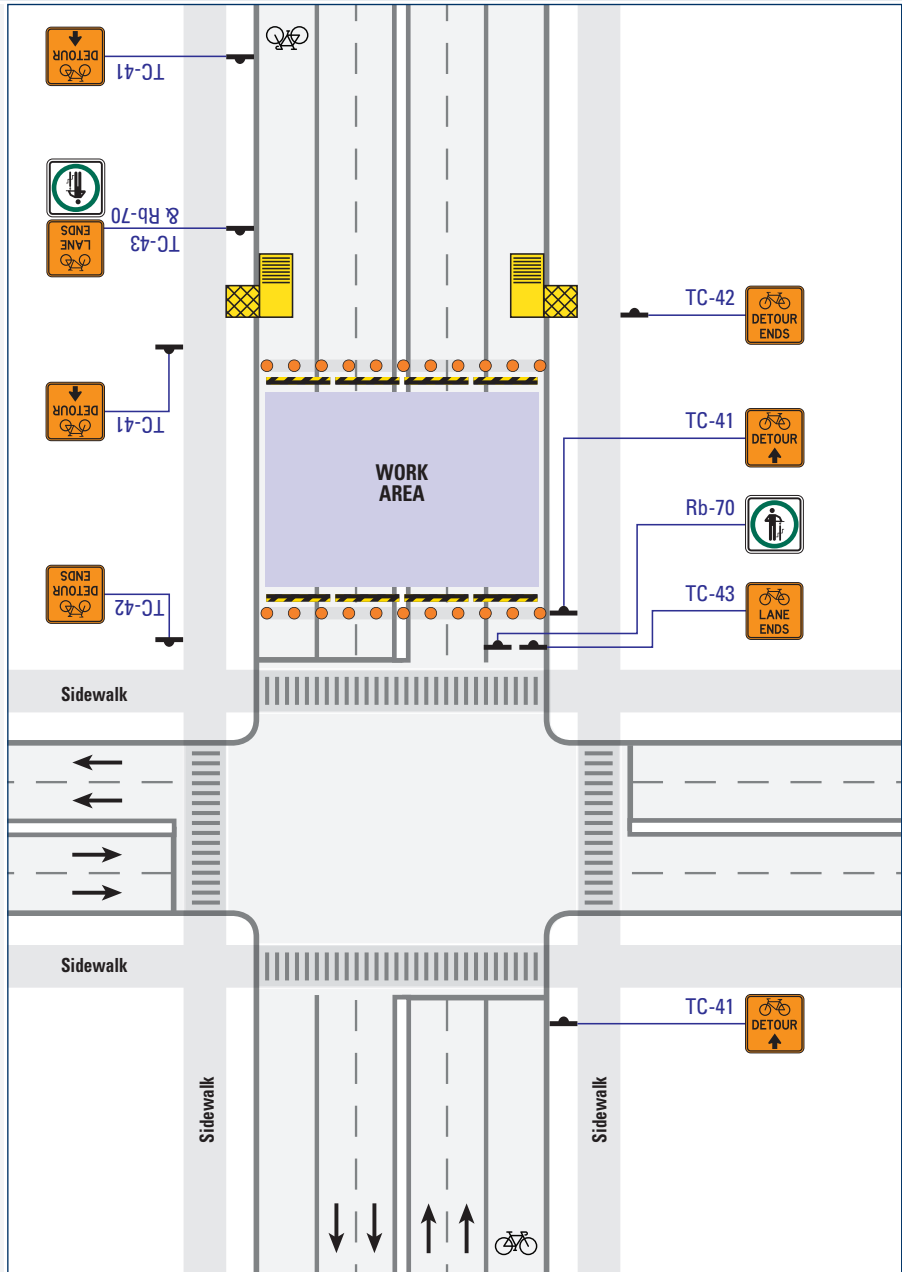

**DO-1**

**Roundabout: Encroachment**

**Multi-Lane Divided**

Mobile Operations

Intermittent

**Very Short Duration**

Short Duration

Long Duration

**NOTES**

- i) It may be necessary to leave a wider lane width if there is a high truck percentage.
- ii) Total lane width of 10 m must be maintained. If minimum lane widths cannot be maintained then see Lane Closure layouts.
- iii) Markers are not required if a Work Vehicle with Beacon + 4WF or TC-12 is present.

For further detail on Work Zone components, see [Table A \(Mobile/Intermittent/Very Short, pg. 240\)](#).

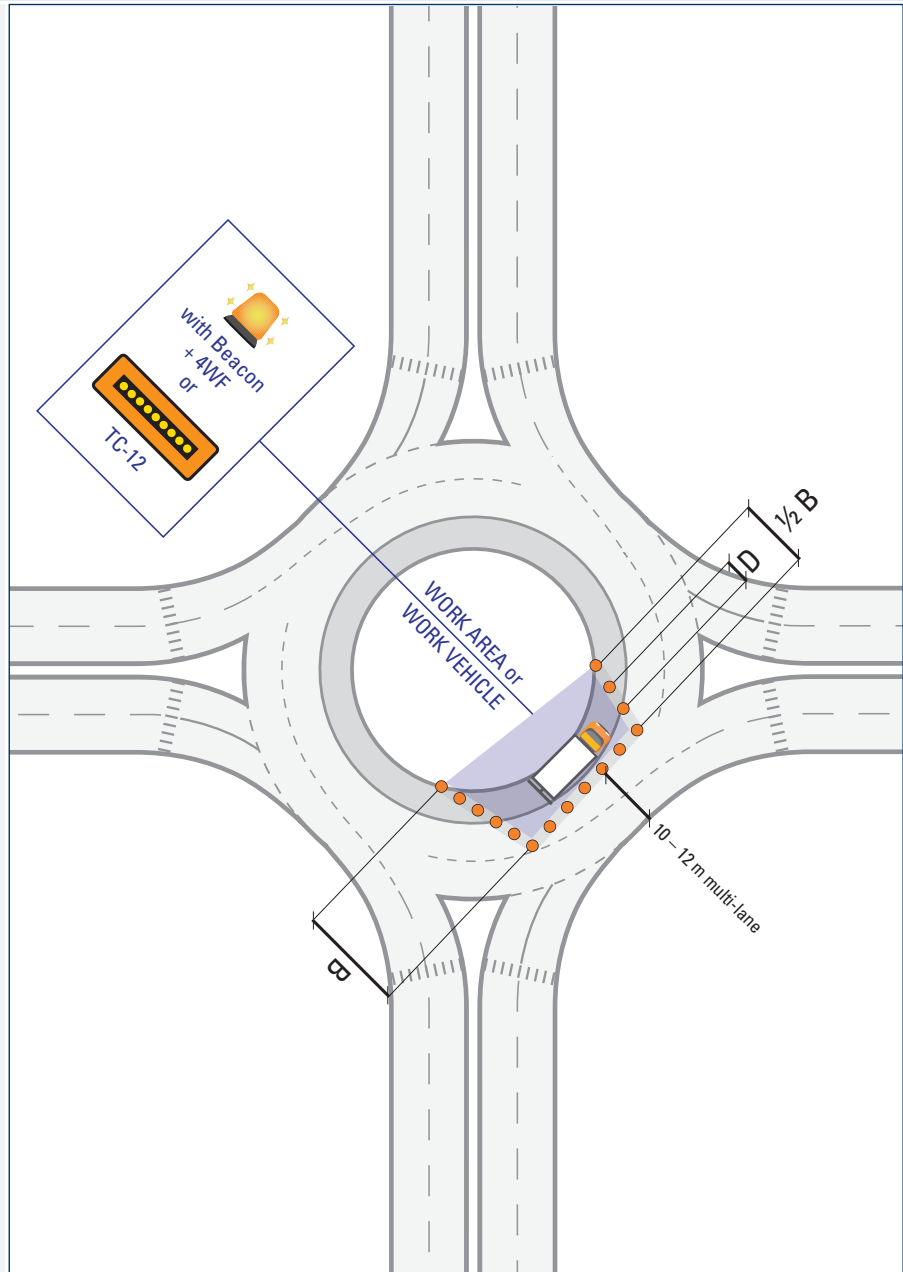

Label	Description	Normal Posted Regulatory Speed (km/h)				
		50	60	70	80	90
<b>B</b>	Shoulder Taper (m)	20	30	35	35	40
<b>D</b>	Maximum Distance between Markers (m)	6	6	9	9	12
	Minimum Number of Markers for Taper	4	5	5	7	8

**DO-2 Roundabout: Encroachment**

**Multi-Lane Divided**

Mobile Operations

Intermittent

Very Short Duration

Short Duration

Long Duration

**NOTES**

i) It may be necessary to leave a wider lane width if there is a high truck percentage.

ii) Total lane width of 10 m must be maintained. If minimum lane widths cannot be maintained then see Lane Closure layouts.

\*The TC-4 sign must be installed at or just beyond the beginning of a lane closure taper.

For further detail on Work Zone components, see [Table B \(Short/Long, pg. 241\)](#).

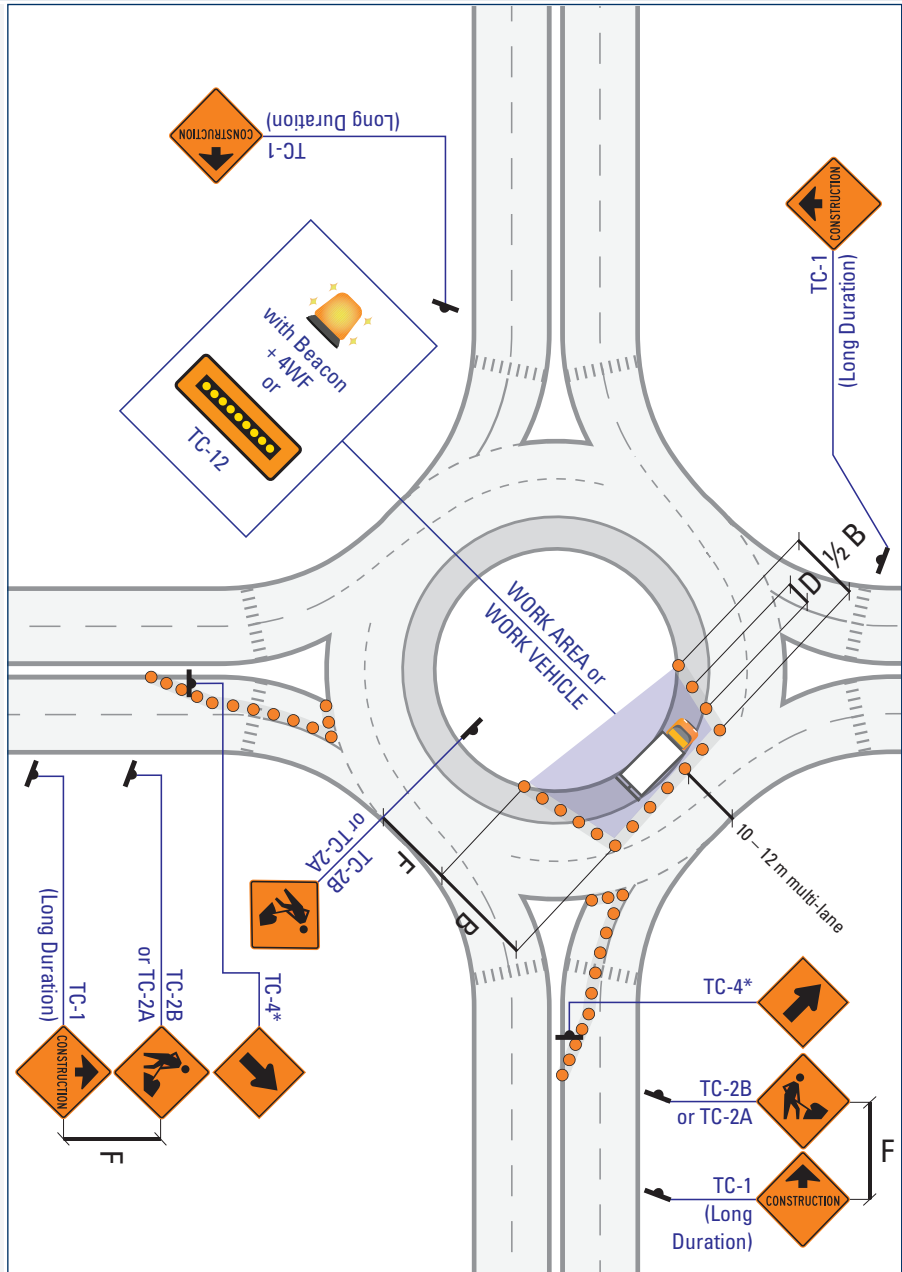

Label	Description	Normal Posted Regulatory Speed (km/h)				
		50	60	70	80	90
<b>B</b>	Shoulder Taper (m)	20	30	55	60	70
<b>D</b>	Maximum Distance between Markers (m)	6	9	9	12	12
	Minimum Number of Markers for Taper	5	7	9	11	13
<b>F</b>	Distance between Construction Signs (m)	50	90	120	140	150

**DO-3 Roundabout: Inside Lane Partially Closed**

Multi-Lane Divided    Mobile Operations    Intermittent    **Very Short Duration**    Short Duration    Long Duration

**NOTES**

i) It may be necessary to leave a wider lane width if there is a high truck percentage.

For further detail on Work Zone components, see [Table A \(Mobile/Intermittent/Very Short, pg. 240\)](#).

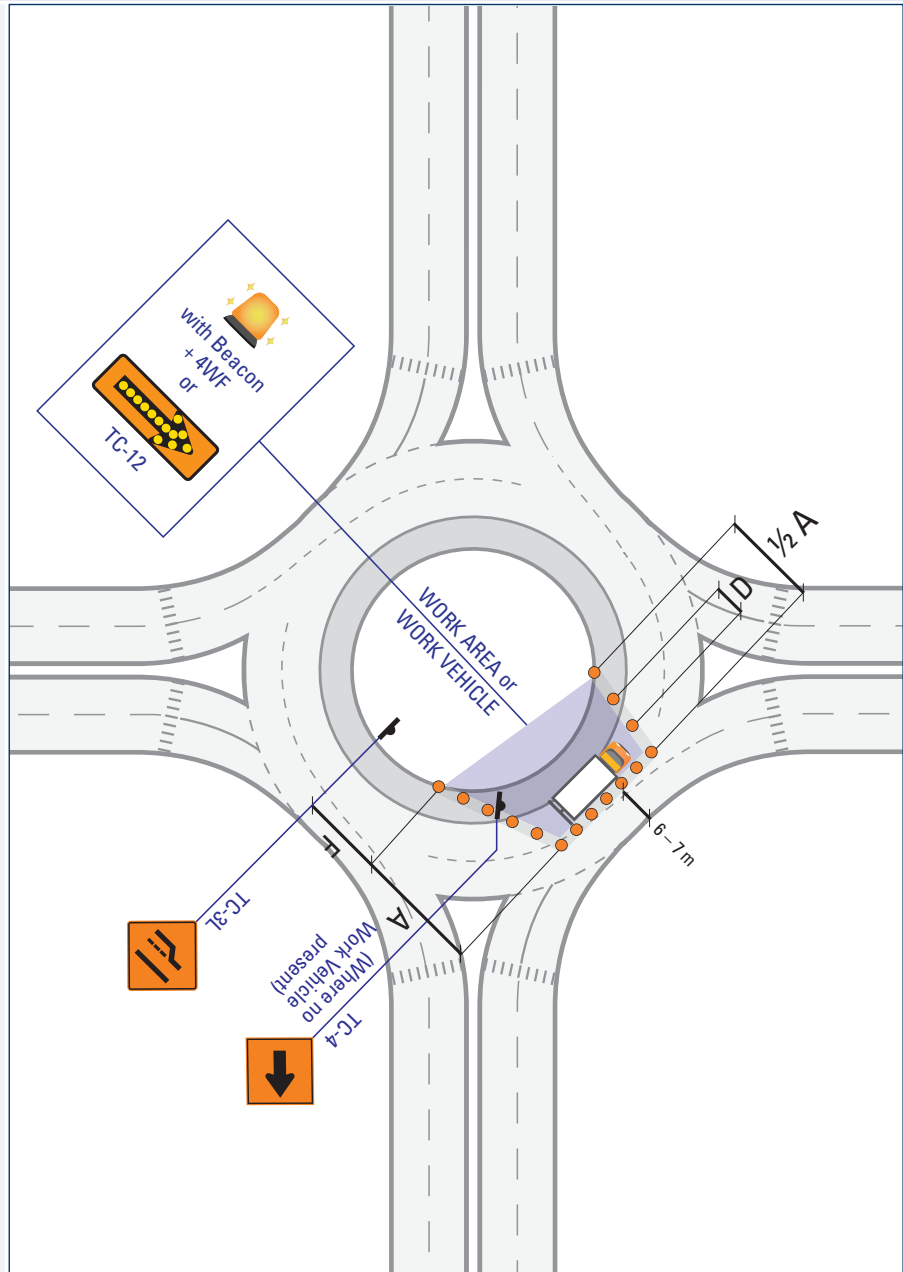

Normal Posted Regulatory Speed (km/h)

Label	Description	Normal Posted Regulatory Speed (km/h)				
		50	60	70	80	90
<b>A</b>	Taper Length for Full Lane Closure (m)	60	85	100	100	110
<b>D</b>	Maximum Distance between Markers (m)	6	6	9	9	12
	Minimum Number of Markers for Taper	4	5	5	7	8
<b>F</b>	Distance between Construction Signs (m)	30	30	60	60	80

**DO-4 Roundabout: Outside Lane Partially Closed**

Multi-Lane Divided    Mobile Operations    Intermittent    **Very Short Duration**    Short Duration    Long Duration

**NOTES**

i) It may be necessary to leave a wider lane width if there is a high truck percentage.

For further detail on Work Zone components, see [Table A \(Mobile/Intermittent/Very Short, pg. 240\)](#).

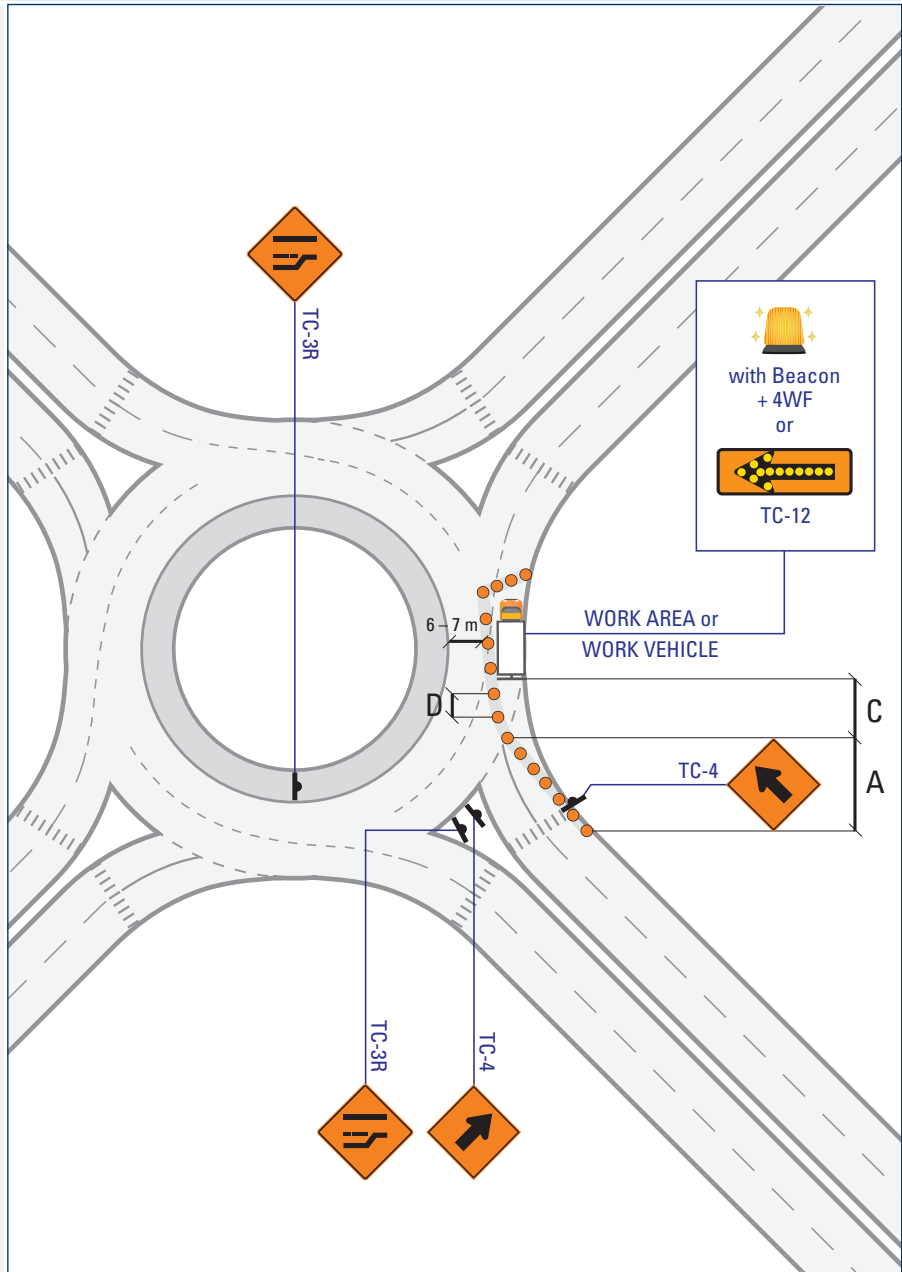

Label	Description	Normal Posted Regulatory Speed (km/h)				
		50	60	70	80	90
<b>A</b>	Taper Length for Full Lane Closure (m)	60	85	100	100	110
<b>C</b>	Longitudinal Buffer Area (LBA) (m)	(30)	(40)	50	60	75
<b>D</b>	Maximum Distance between Markers (m)	6	6	9	9	12
	Minimum Number of Markers for Taper	4	5	5	7	8

**DO-5**

**Roundabout: Left Exit or Partial Outside Lane Closed**

**Multi-Lane Divided**

Mobile Operations

Intermittent

**Very Short Duration**

Short Duration

Long Duration

**NOTES**

i) It may be necessary to leave a wider lane width if there is a high truck percentage.

\*The TC-4 sign must be installed at or just beyond the beginning of a lane closure taper.

For further detail on Work Zone components, see [Table A \(Mobile/Intermittent/Very Short, pg. 240\)](#).

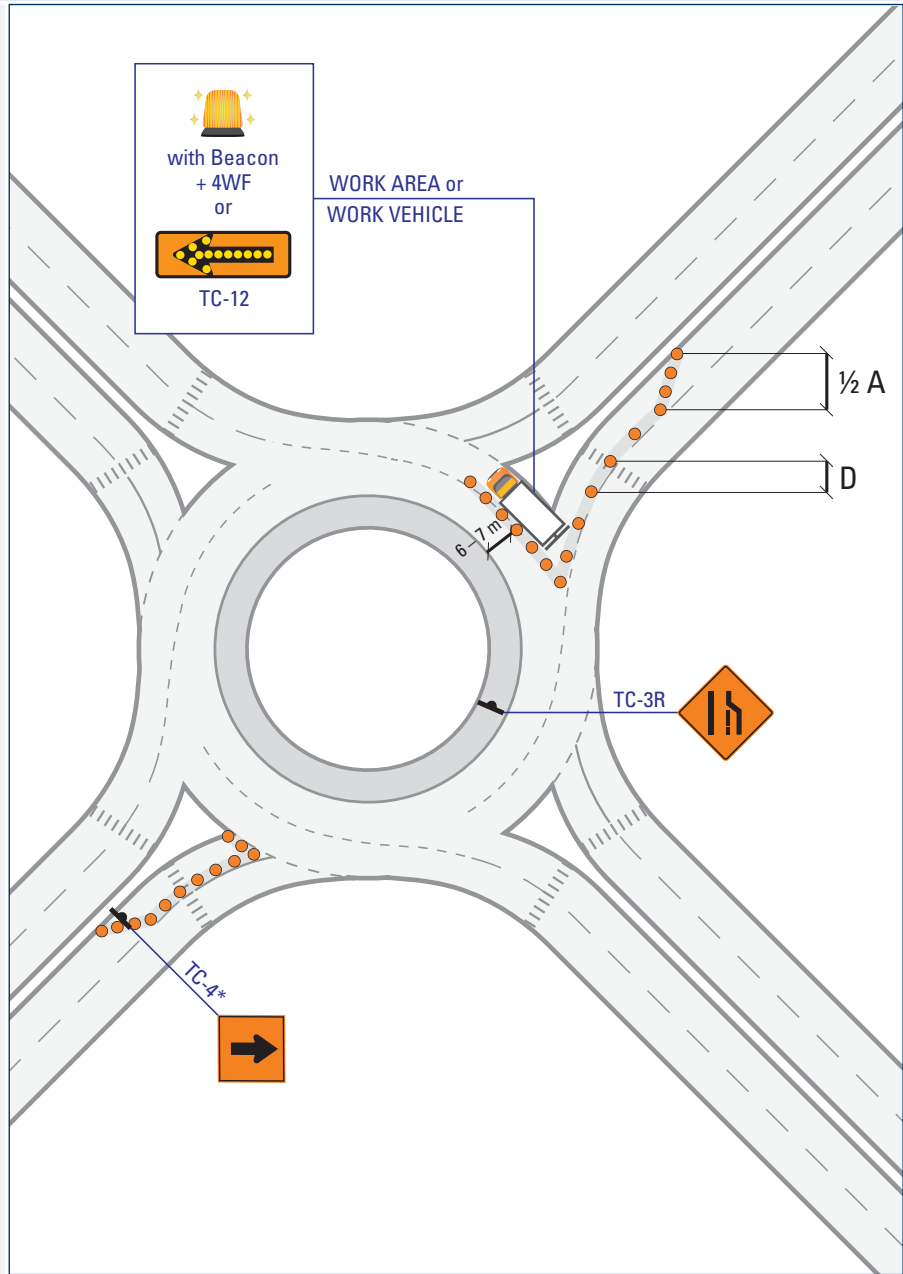

Label	Description	Normal Posted Regulatory Speed (km/h)				
		50	60	70	80	90
<b>A</b>	Taper Length for Full Lane Closure (m)	60	85	100	100	100
<b>D</b>	Maximum Distance between Markers (m)	6	6	9	9	12
	Minimum Number of Markers for Taper	4	5	5	7	8

**DO-6 Roundabout: Inside Lane Closed**

**Multi-Lane Divided**

Mobile Operations

Intermittent

Very Short Duration

Short Duration

Long Duration

**NOTES**

i) It may be necessary to leave a wider lane width if there is a high truck percentage.

ii) Work Area may be anywhere in the inside lane. All entrances must be reduced to one lane.

\*The TC-4 sign must be installed at or just beyond the beginning of a lane closure taper.

For further detail on Work Zone components, see [Table B \(Short/Long, pg. 241\)](#).

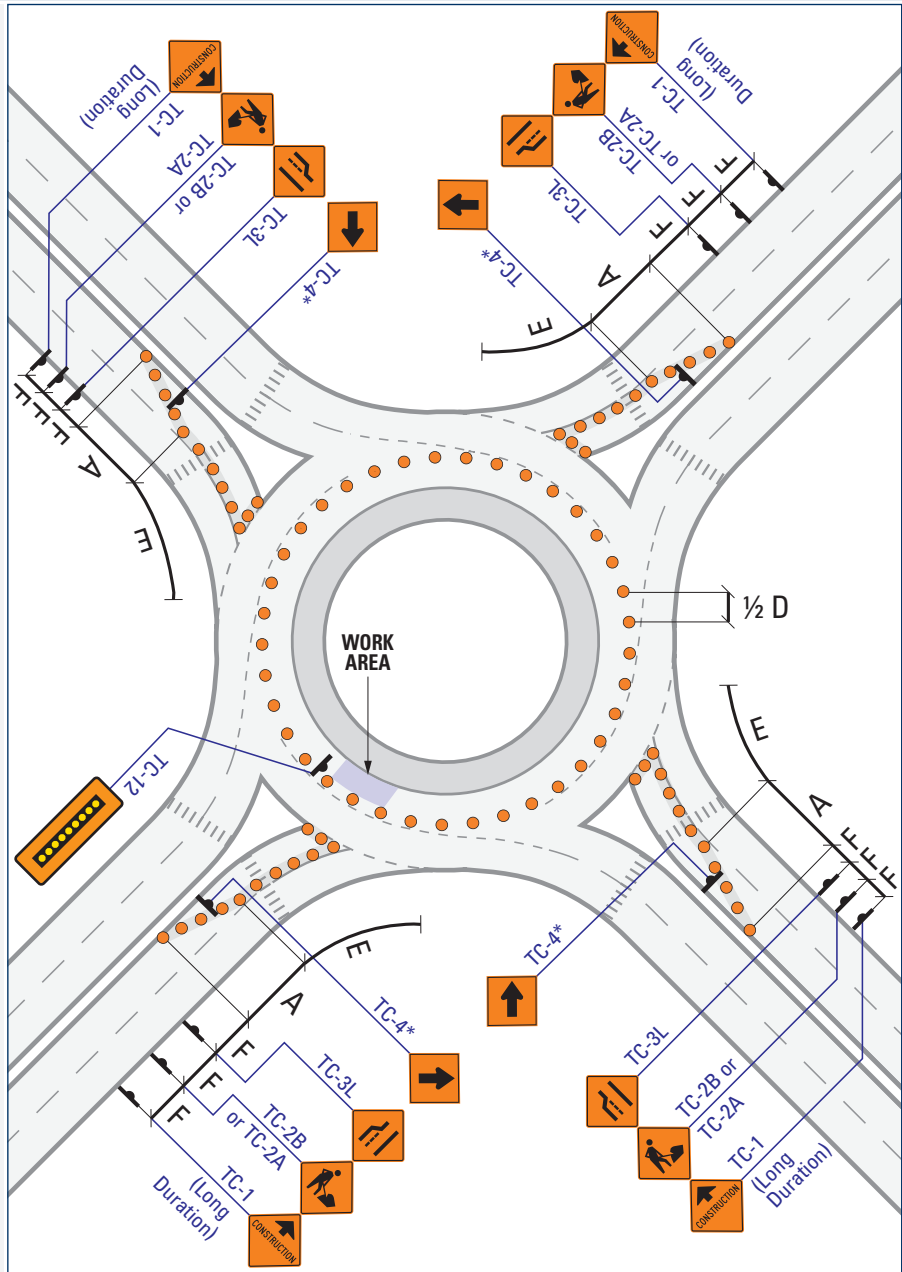

Label	Description	Normal Posted Regulatory Speed (km/h)				
		50	60	70	80	90
<b>A</b>	Taper Length for Full Lane Closure (m)	60	85	155	180	200
<b>D</b>	Maximum Distance between Markers (m)	6	9	9	12	12
	Minimum Number of Markers for Taper	5	7	9	11	13
<b>E</b>	Minimum Tangent between Tapers (m)	60	85	155	180	200
<b>F</b>	Distance between Construction Signs (m)	50	90	120	140	150

**DO-7 Roundabout: Outside Lane Closed**

**Multi-Lane Divided**    Mobile Operations    Intermittent    Very Short Duration    **Short Duration**    Long Duration

**NOTES**

i) It may be necessary to leave a wider lane width if there is a high truck percentage.

ii) Work Area may be in any of the closed quadrants. All entrances and exits must be reduced to one lane.

\*The TC-4 sign must be installed at or just beyond the beginning of a lane closure taper.

For further detail on Work Zone components, see [Table B \(Short/Long, pg. 241\)](#).

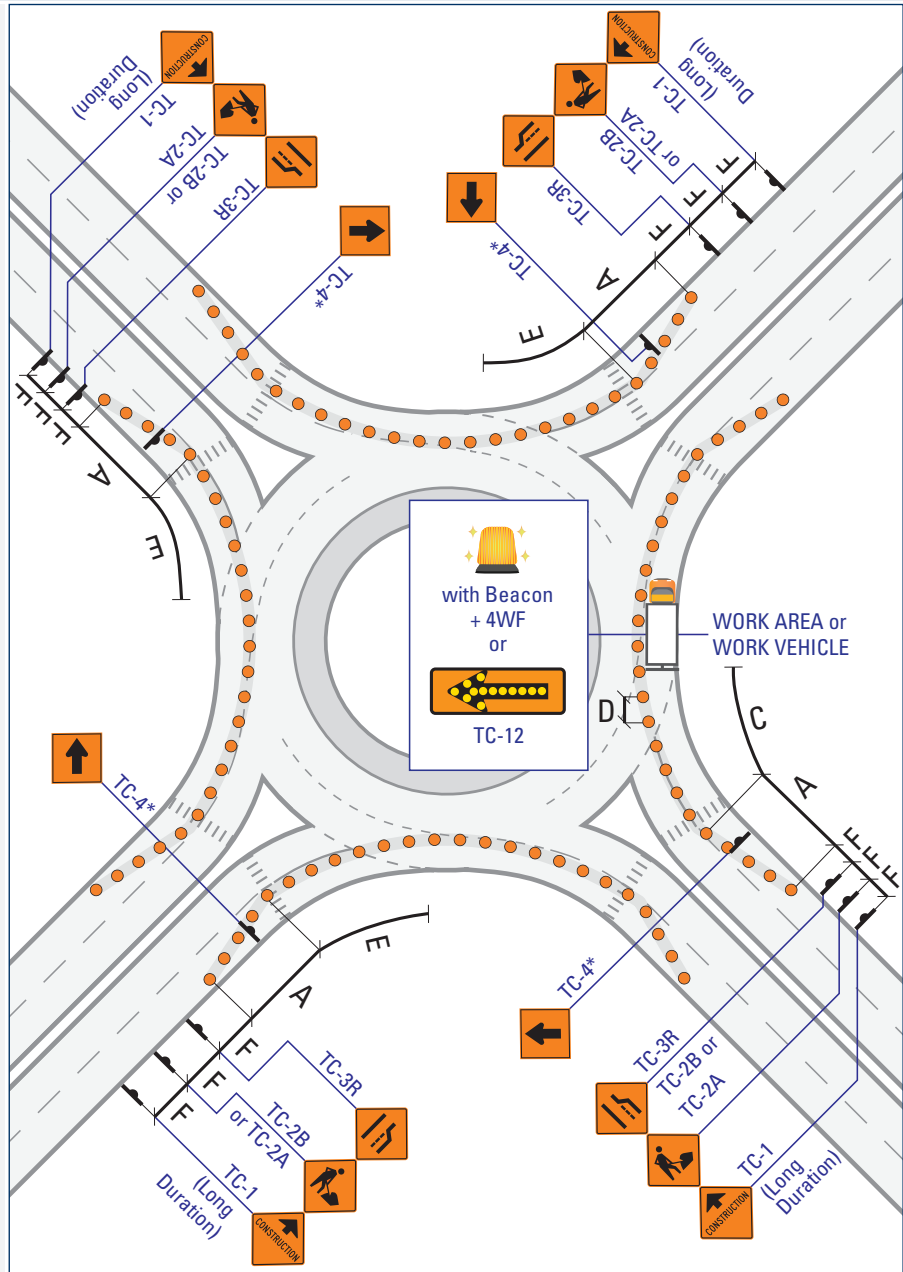

Normal Posted Regulatory Speed (km/h)

Label	Description	50	60	70	80	90
<b>A</b>	Taper Length for Full Lane Closure (m)	60	85	155	180	200
<b>C</b>	Longitudinal Buffer Area (LBA) (m)	(30)	(40)	50	60	75
<b>D</b>	Maximum Distance between Markers (m)	6	9	9	12	12
	Minimum Number of Markers for Taper	5	7	9	11	13
<b>E</b>	Minimum Tangent between Tapers (m)	60	85	155	180	200
<b>F</b>	Distance between Construction Signs (m)	50	90	120	140	150



**DO-8 Roundabout: Left Exit or Partial Outside Lane Closed**

**Multi-Lane Divided**

Mobile Operations

Intermittent

Very Short Duration

Short Duration

Long Duration

**NOTES**

- i) It may be necessary to leave a wider lane width if there is a high truck percentage.
  - ii) All entrances must be reduced to one lane.
- \*The TC-4 sign must be installed at or just beyond the beginning of a lane closure taper.

For further detail on Work Zone components, see [Table B \(Short/Long, pg. 241\)](#).

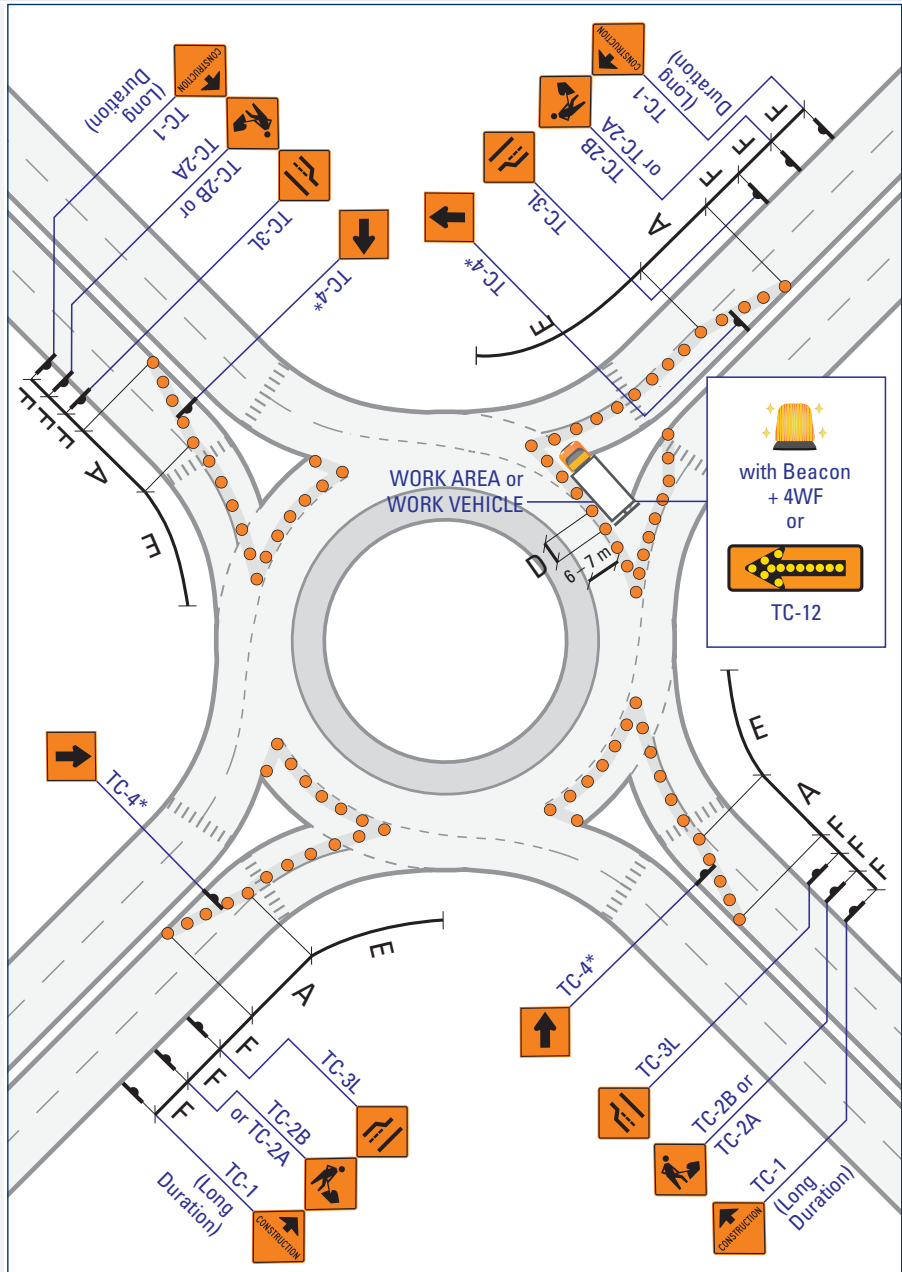

Label	Description	Normal Posted Regulatory Speed (km/h)				
		50	60	70	80	90
<b>A</b>	Taper Length for Full Lane Closure (m)	60	85	155	180	200
<b>D</b>	Maximum Distance between Markers (m)	6	9	9	12	12
	Minimum Number of Markers for Taper	5	7	9	11	13
<b>E</b>	Minimum Tangent between Tapers (m)	60	85	155	180	200
<b>F</b>	Distance between Construction Signs (m)	50	90	120	140	150

**DO-9 Roundabout: One Exit Closed (Detour)**

Multi-Lane Divided    Mobile Operations    Intermittent    Very Short Duration    **Short Duration**    Long Duration

**NOTES**

i) See DS-17 and DS-18 for Detour signing in advance and beyond the Roundabout.

ii) Any existing signs that contradict or that are duplicated should be covered.

For further detail on Work Zone components, see [Table B \(Short/Long, pg. 241\)](#).

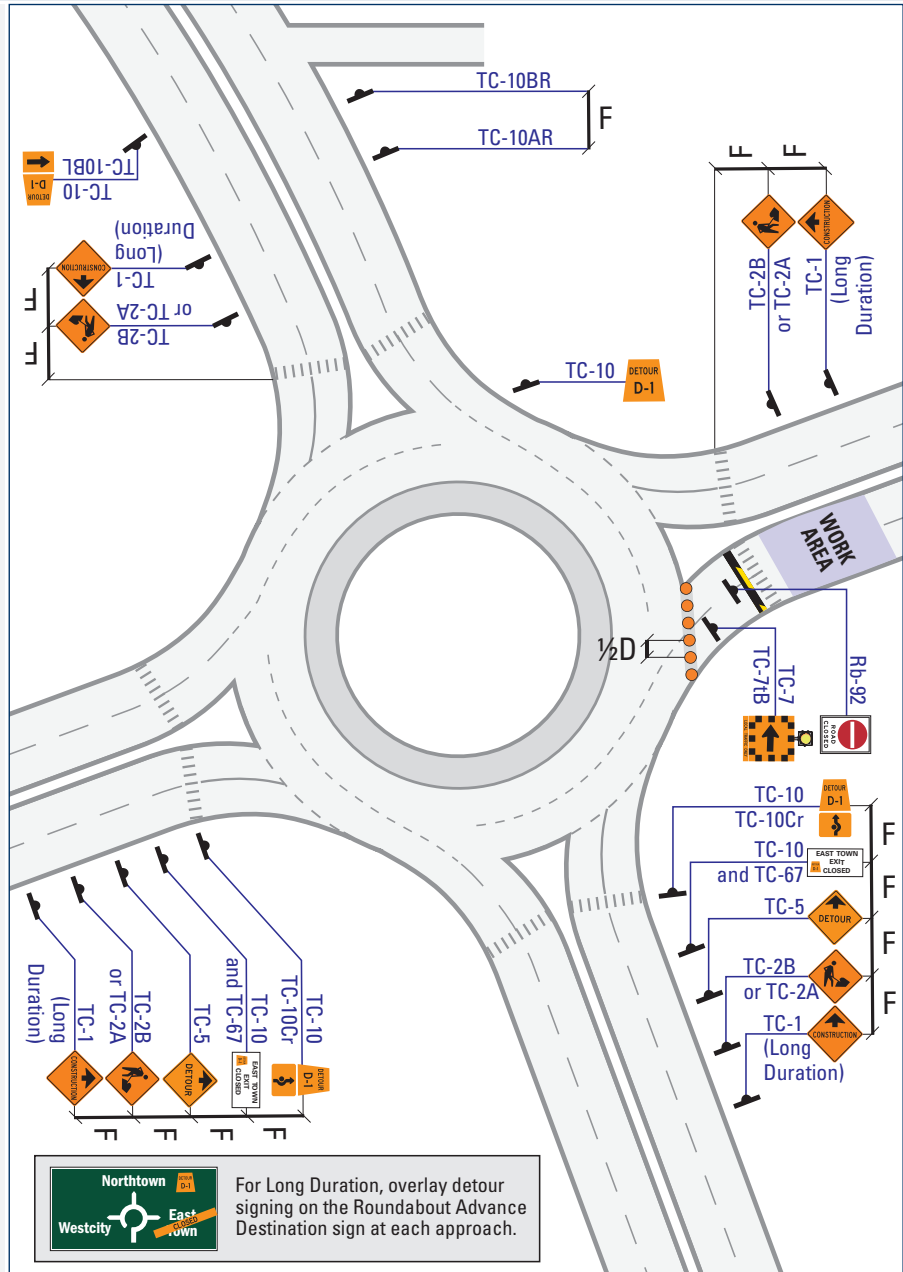

Label	Description	Normal Posted Regulatory Speed (km/h)				
		50	60	70	80	90
<b>D</b>	Maximum Distance between Markers (m)	6	9	9	12	12
	Minimum Number of Markers for Taper	5	7	9	11	13
<b>F</b>	Distance between Construction Signs (m)	50	90	120	140	150

**DR-1 Lane Closed at Exit Ramp**

**Multi-Lane Divided**

Mobile Operations

Intermittent

Very Short Duration

Short Duration

Long Duration

**NOTES**

i) For Right Lane Closed, see DS-15.

ii) In the immediate area of the exit, Marker spacings of half of those shown on Table B should be used.

For further detail on Work Zone components, see [Table B \(Short/Long, pg. 241\)](#).

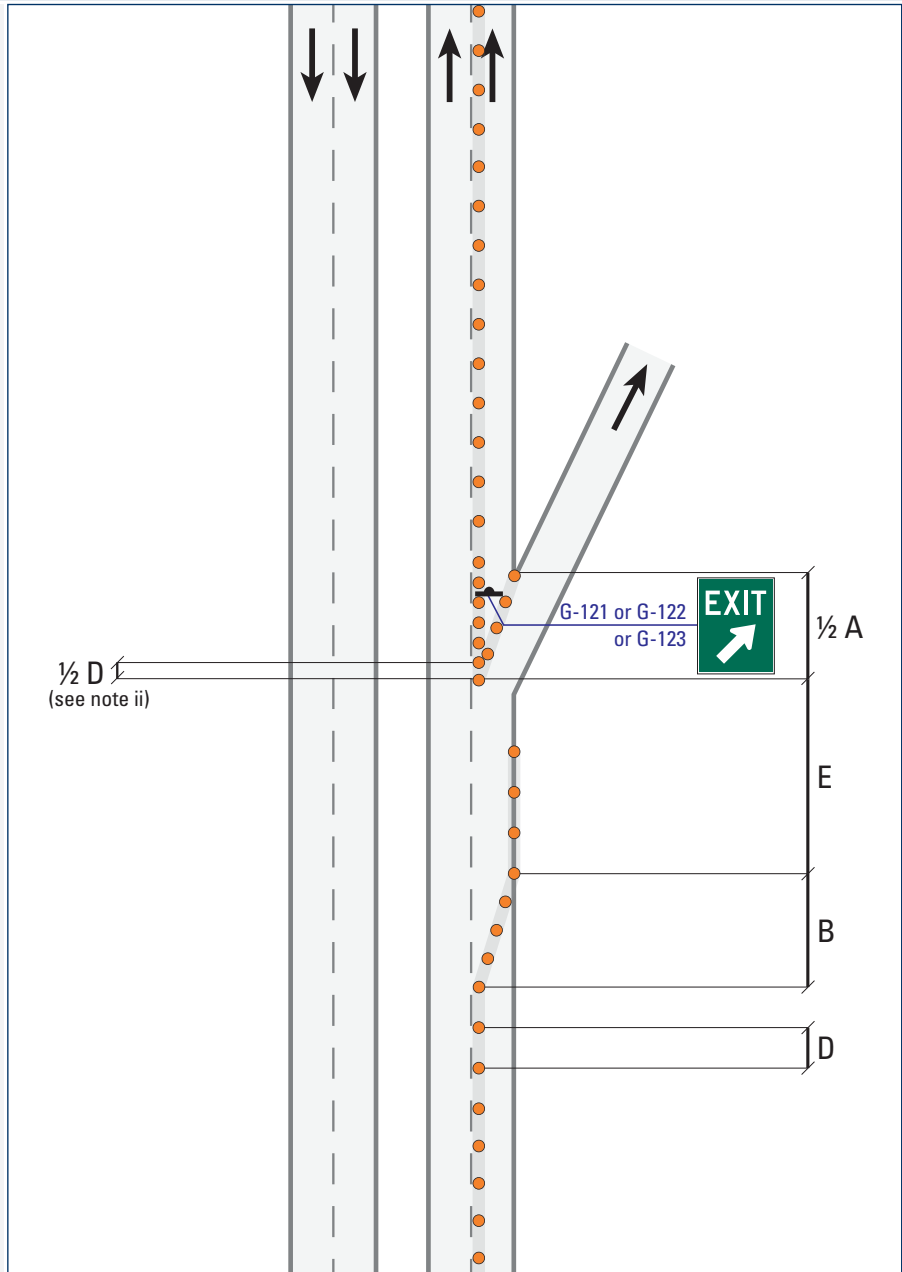

Label	Description	Normal Posted Regulatory Speed (km/h)				
		50	60	70	80	90
<b>A</b>	Taper Length for Full Lane Closure (m)	60	85	155	180	200
<b>B</b>	Shoulder Taper (m)	20	30	55	60	70
<b>D</b>	Maximum Distance between Markers (m)	6	9	9	12	12
	Minimum Number of Markers for Taper	5	7	9	11	13
<b>E</b>	Minimum Tangent between Tapers (m)	60	85	155	180	200

**DR-2 Lane Closed at Exit Ramp with a Deceleration Lane**

**Multi-Lane Divided**    Mobile Operations    Intermittent    Very Short Duration    Short Duration    Long Duration

**NOTES**

i) For Right Lane Closed, see DS-15.

ii) In the immediate area of the exit, Marker spacings of half of those shown on Table B should be used.

For further detail on Work Zone components, see [Table B \(Short/Long, pg. 241\)](#).

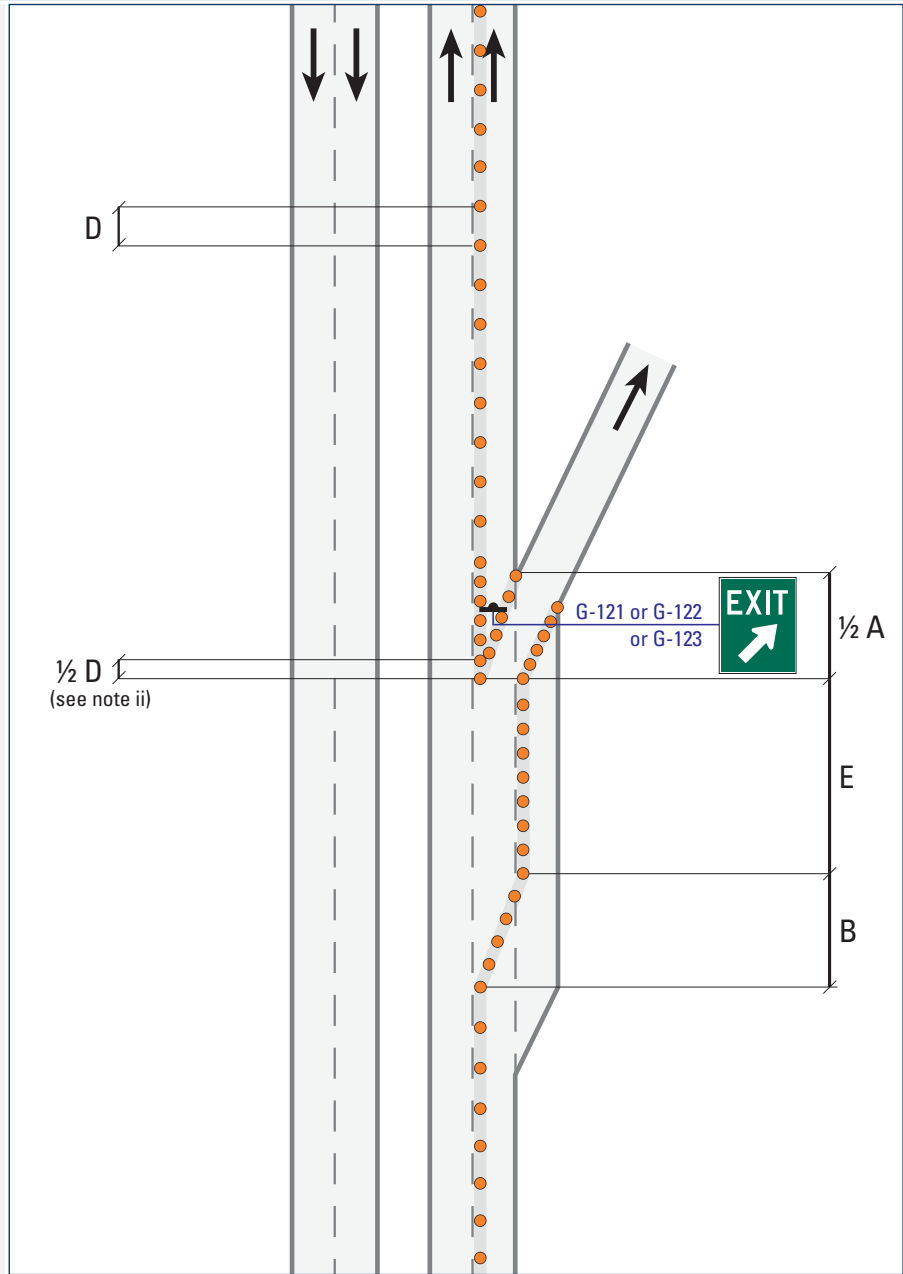

Label	Description	Normal Posted Regulatory Speed (km/h)				
		50	60	70	80	90
<b>A</b>	Taper Length for Full Lane Closure (m)	60	85	155	180	200
<b>B</b>	Shoulder Taper (m)	20	30	55	60	70
<b>D</b>	Maximum Distance between Markers (m)	6	9	9	12	12
	Minimum Number of Markers for Taper	5	7	9	11	13
<b>E</b>	Minimum Tangent between Tapers (m)	60	85	155	180	200

**DR-3 Lane Closed at Entrance Ramp**

Multi-Lane Divided    Mobile Operations    Intermittent    Very Short Duration    Short Duration    Long Duration

**NOTES**

- i) For Right Lane Closed, see DS-15.
- ii) Where space and work activities permit, the acceleration lane should be made as long as possible.
- iii) In the immediate area of the entrance, Marker spacings of half of those shown on Table B should be used.

\*The TC-4 sign must be installed at or just beyond the beginning of a lane closure taper.

For further detail on Work Zone components, see [Table B \(Short/Long, pg. 241\)](#).

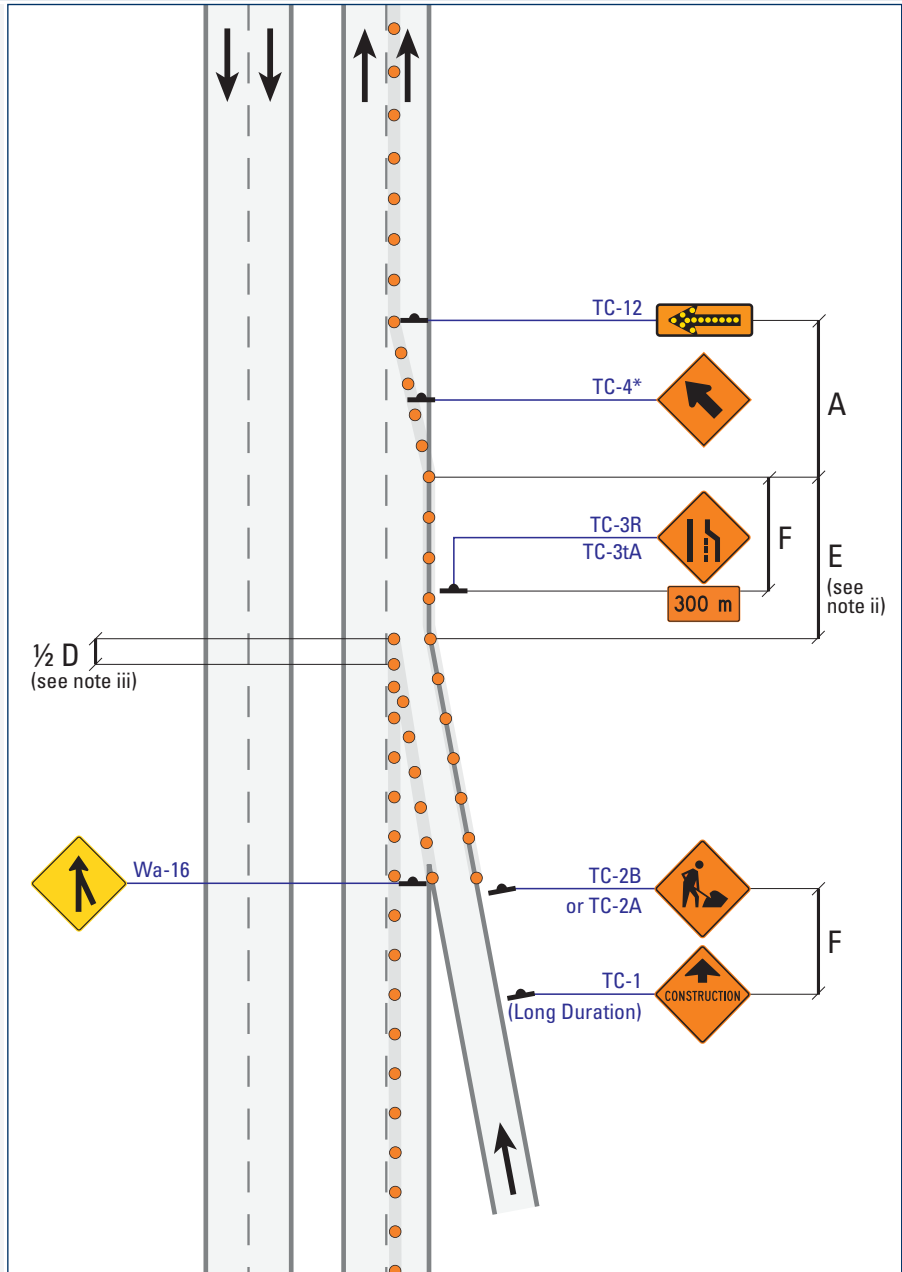

Label	Description	Normal Posted Regulatory Speed (km/h)				
		50	60	70	80	90
<b>A</b>	Taper Length for Full Lane Closure (m)	60	85	155	180	200
<b>D</b>	Maximum Distance between Markers (m)	6	9	9	12	12
	Minimum Number of Markers for Taper	5	7	9	11	13
<b>E</b>	Minimum Tangent between Tapers (m)	60	85	155	180	200
<b>F</b>	Distance between Construction Signs (m)	50	90	120	140	150

**DR-4 Lane Closed at Entrance Ramp with an Acceleration Lane**

**Multi-Lane Divided**    Mobile Operations    Intermittent    Very Short Duration    **Short Duration**    Long Duration

**NOTES**

- i) For Right Lane Closed, see DS-15.
- ii) Where space and work activities permit, the acceleration lane should be made as long as possible.
- iii) In the immediate area of the entrance, Marker spacings of half of those shown on Table B should be used.

\*The TC-4 sign must be installed at or just beyond the beginning of a lane closure taper.

For further detail on Work Zone components, see [Table B \(Short/Long, pg. 241\)](#).

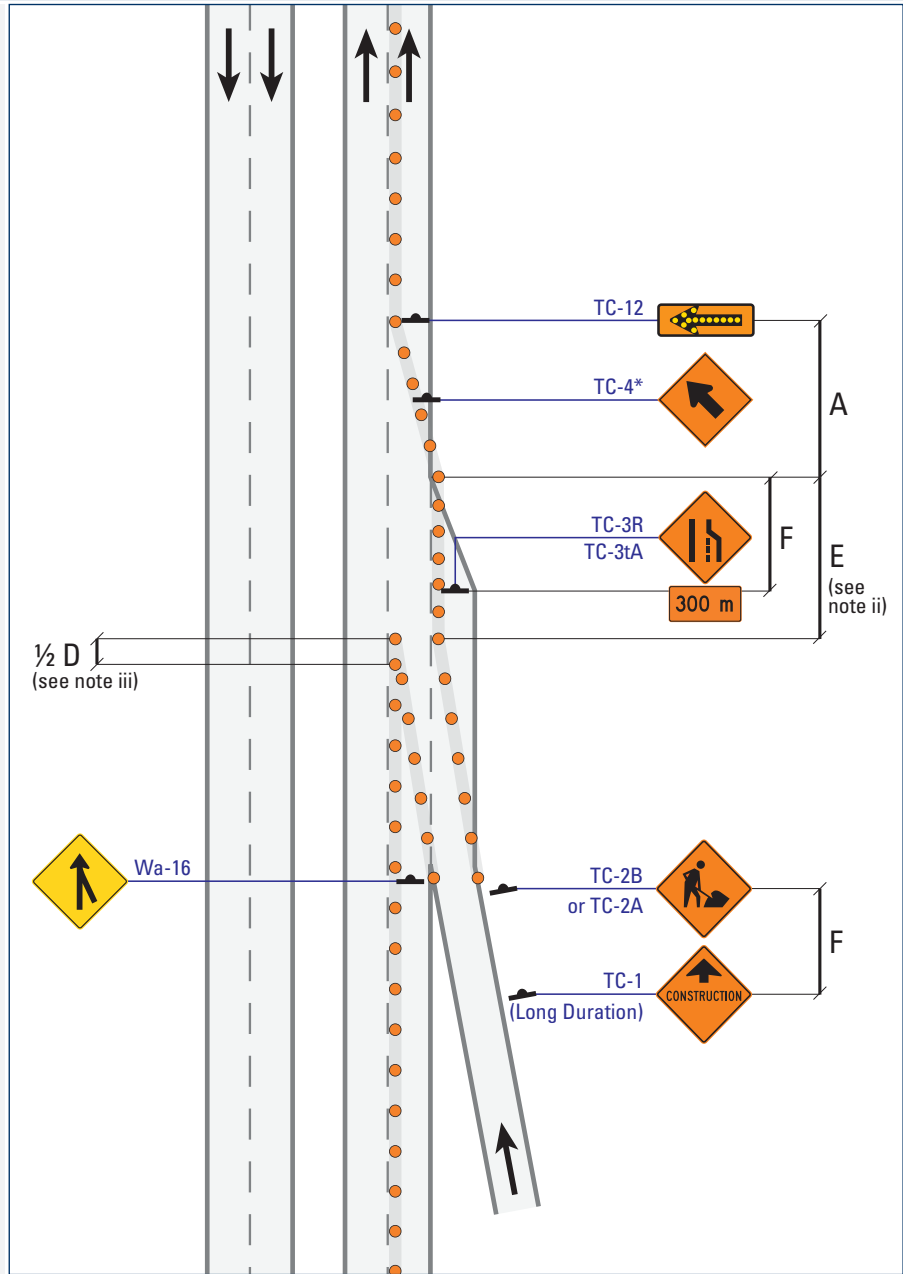

Normal Posted Regulatory Speed (km/h)

Label	Description	50	60	70	80	90
<b>A</b>	Taper Length for Full Lane Closure (m)	60	85	155	180	200
<b>D</b>	Maximum Distance between Markers (m)	6	9	9	12	12
	Minimum Number of Markers for Taper	5	7	9	11	13
<b>E</b>	Minimum Tangent between Tapers (m)	60	85	155	180	200
<b>F</b>	Distance between Construction Signs (m)	50	90	120	140	150

**DR-5 Ramp Closed**

**Multi-Lane Divided**

Mobile Operations

Intermittent

Very Short Duration

**Short Duration**

Long Duration

**NOTES**

i) Closed sign on Directional Guide Signs to be used for Long Duration only. For details, see OTM Book 8.

For further detail on Work Zone components, see [Table B \(Short/Long, pg. 241\)](#).

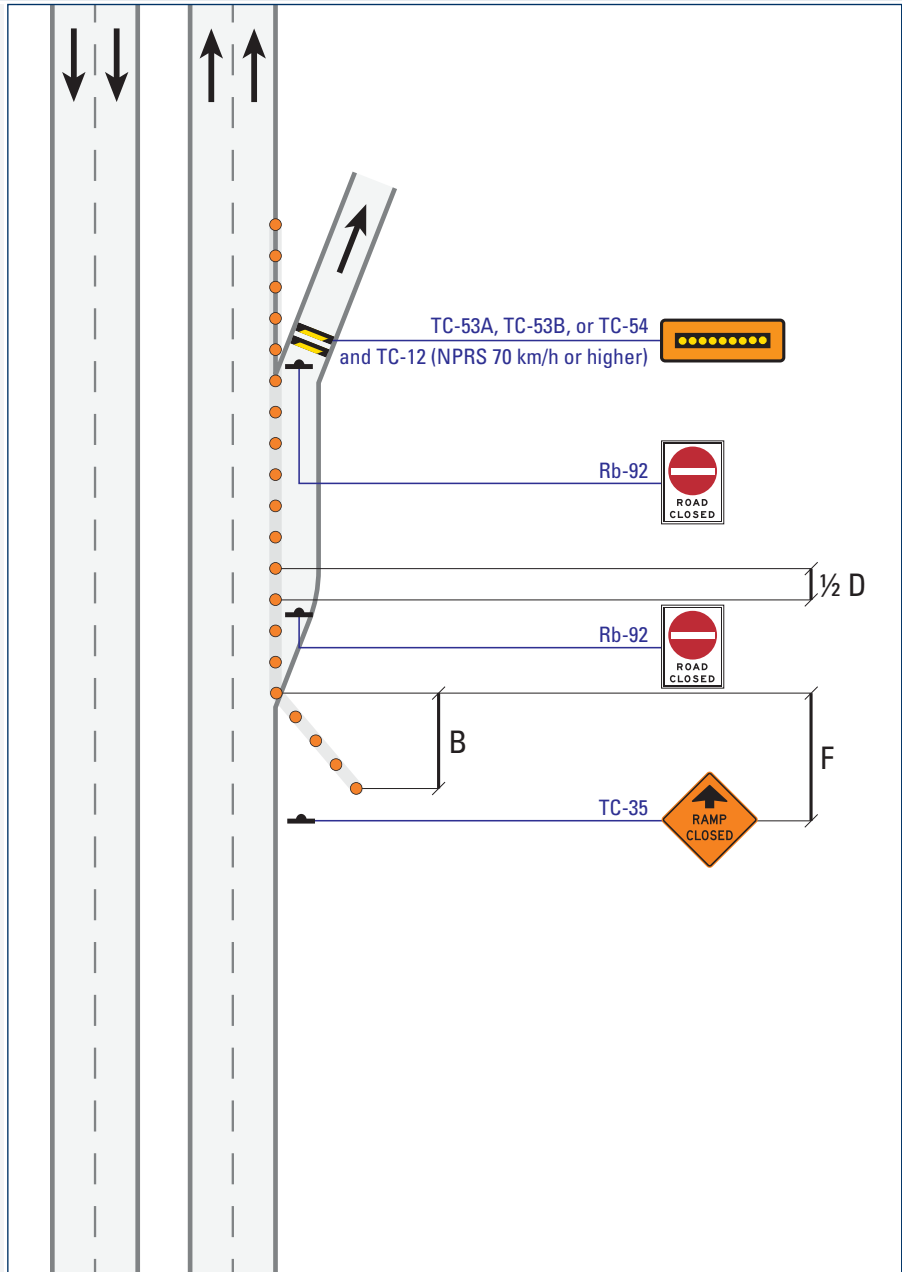

Label	Description	Normal Posted Regulatory Speed (km/h)				
		50	60	70	80	90
<b>B</b>	Shoulder Taper (m)	20	30	55	60	70
<b>D</b>	Maximum Distance between Markers (m)	6	9	9	12	12
	Minimum Number of Markers for Taper	5	7	9	11	13
<b>F</b>	Distance between Construction Signs (m)	50	90	120	140	150

**DR-6 Right Developed Lane Closed**

**Multi-Lane Divided**    Mobile Operations    Intermittent    Very Short Duration    Short Duration    Long Duration

**NOTES**

i) Left Developed Lane Closed: mirror image of Right Developed Lane Closed.

For further detail on Work Zone components, see [Table B \(Short/Long, pg. 241\)](#).

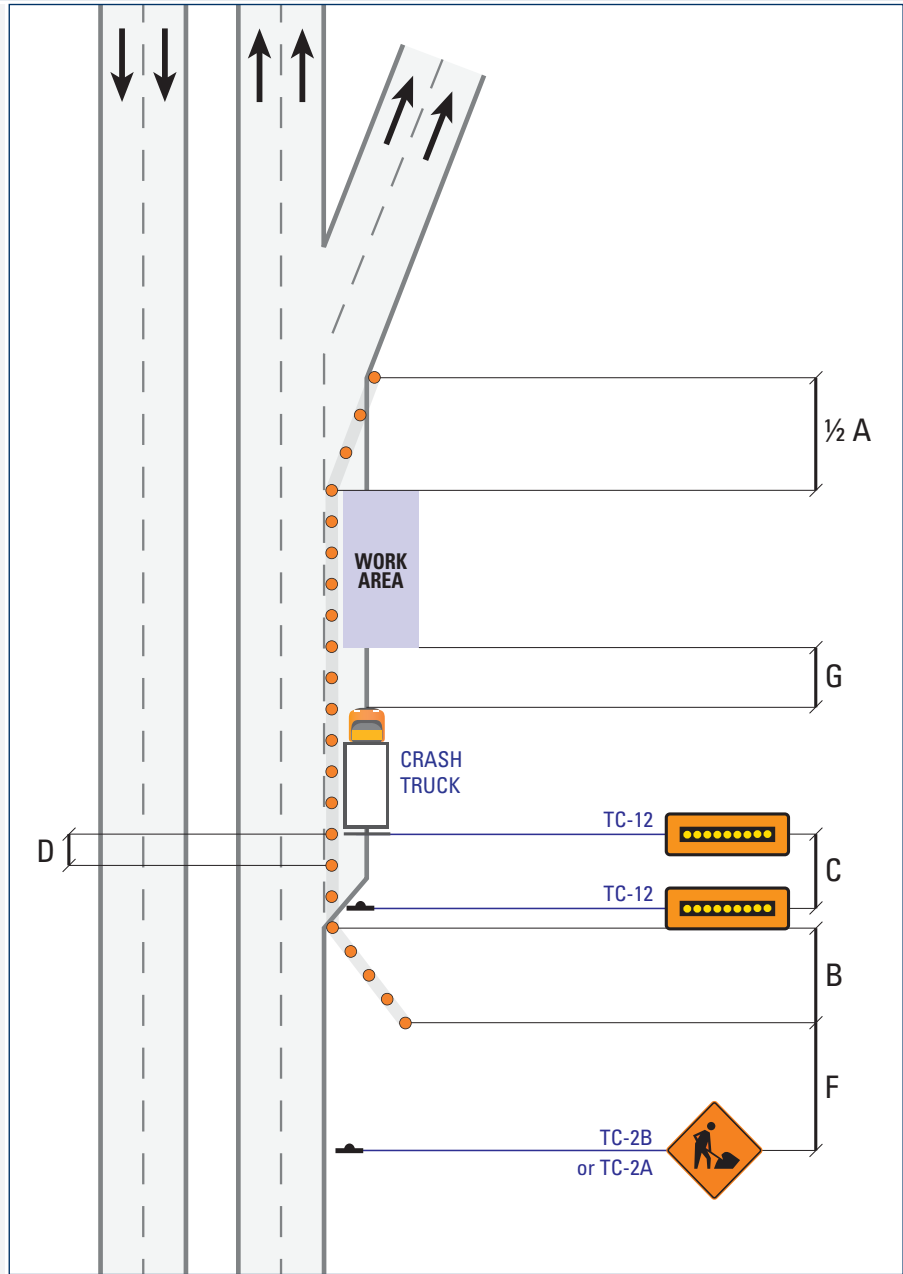

Normal Posted Regulatory Speed (km/h)

Label	Description	50	60	70	80	90
<b>A</b>	Taper Length for Full Lane Closure (m)	60	85	155	180	200
<b>B</b>	Shoulder Taper (m)	20	30	55	60	70
<b>C</b>	Longitudinal Buffer Area (LBA) (m)	(30)	(40)	50	60	75
<b>D</b>	Maximum Distance between Markers (m)	6	9	9	12	12
	Minimum Number of Markers for Taper	5	7	9	11	13
<b>F</b>	Distance between Construction Signs (m)	50	90	120	140	150
<b>G</b>	Stationary Work (Lateral Intrusion Deterrence Gap (LIDG) (m)	(35)	(40)	50	60	65



**FG-1 Designated Construction Zone Signing**

Freeway Mobile Operations Intermittent Very Short Duration Short Duration Long Duration

**NOTES**

- i) Where signs cannot be accommodated in the median, provide additional oversize signs on the right shoulder as practicable.
- ii) Recommended, but not required.
- iii) Where required by contract.
- iv) Supplementary layout. This layout shall be used in conjunction with other appropriate layouts. Locations of TC-1, TC-1A, TC-1B shown in FG-1 overrides the locations shown in other layouts when used in conjunction with FG-1.

For further detail on Work Zone components, see [Table C \(Freeways, pg. 242\)](#).

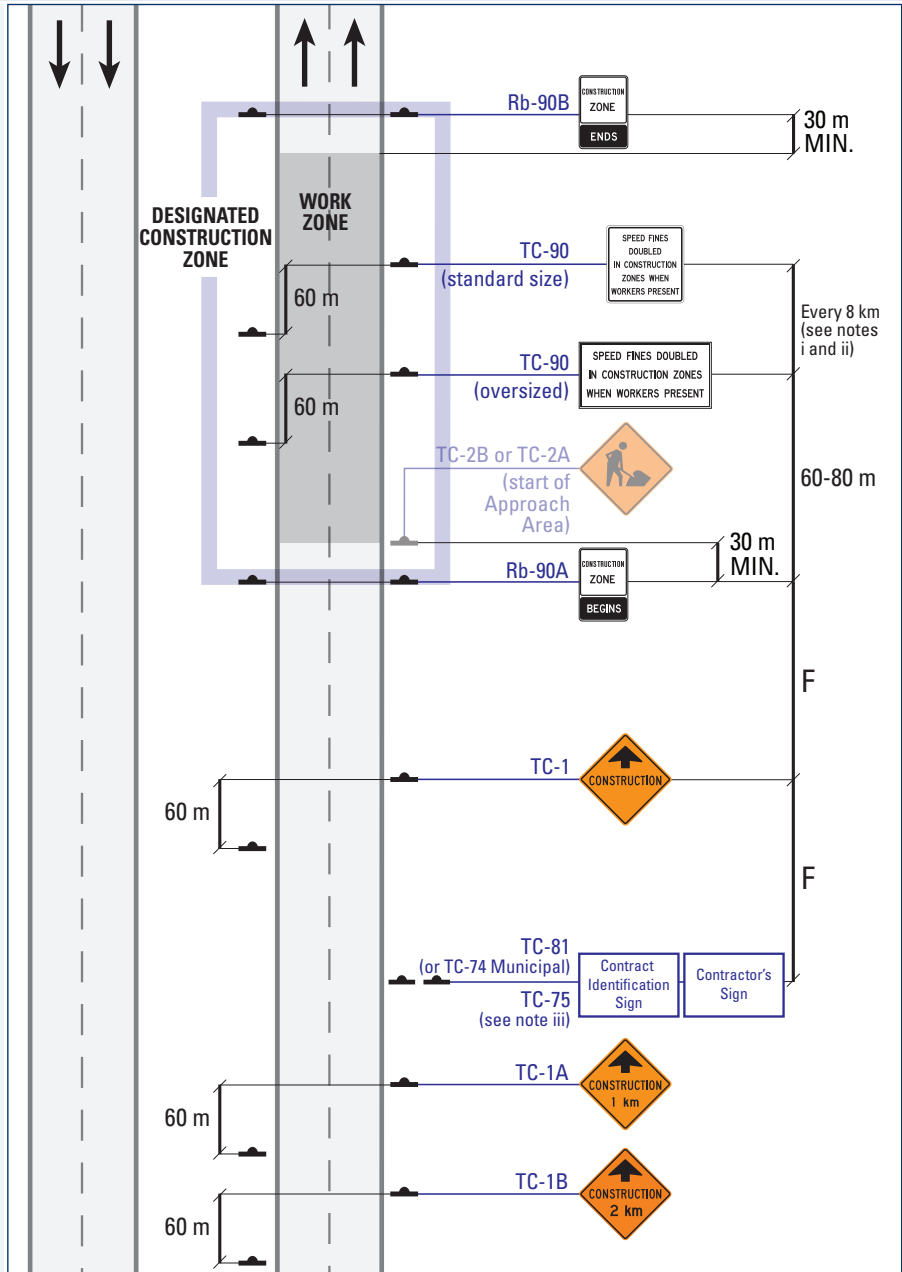

Label	Description	Normal Posted Regulatory Speed (km/h)			
		80	90	100	110
<b>F</b>	Distance between Construction Signs (m)	160	180	200	200

**FG-2 Reduced Speed Zone Signing**

**Freeway**      Mobile Operations      Intermittent      Very Short Duration      **Short Duration**      Long Duration

- NOTES**
- i) Refer to Regulation 615 of the Highway Traffic Act and OTM Book 5 for distance between regulatory speed limit signs.
  - ii) For Regulatory Speed Reduction, a Designated Construction Zone must be established and signed as per FG-1.
  - iii) Where signs cannot be accommodated in the median, provide additional signs on the right shoulder or oversize as practicable.
  - iv) Reduced Speed Zone may include all of or only part(s) of the Designated Construction Zone.
  - v) Additional signs may be required based on the length of zone.
  - vi) Supplementary layout. This layout shall be used in conjunction with other appropriate layouts.
- For further detail on Work Zone components, see [Table C \(Freeways, pg. 242\)](#).

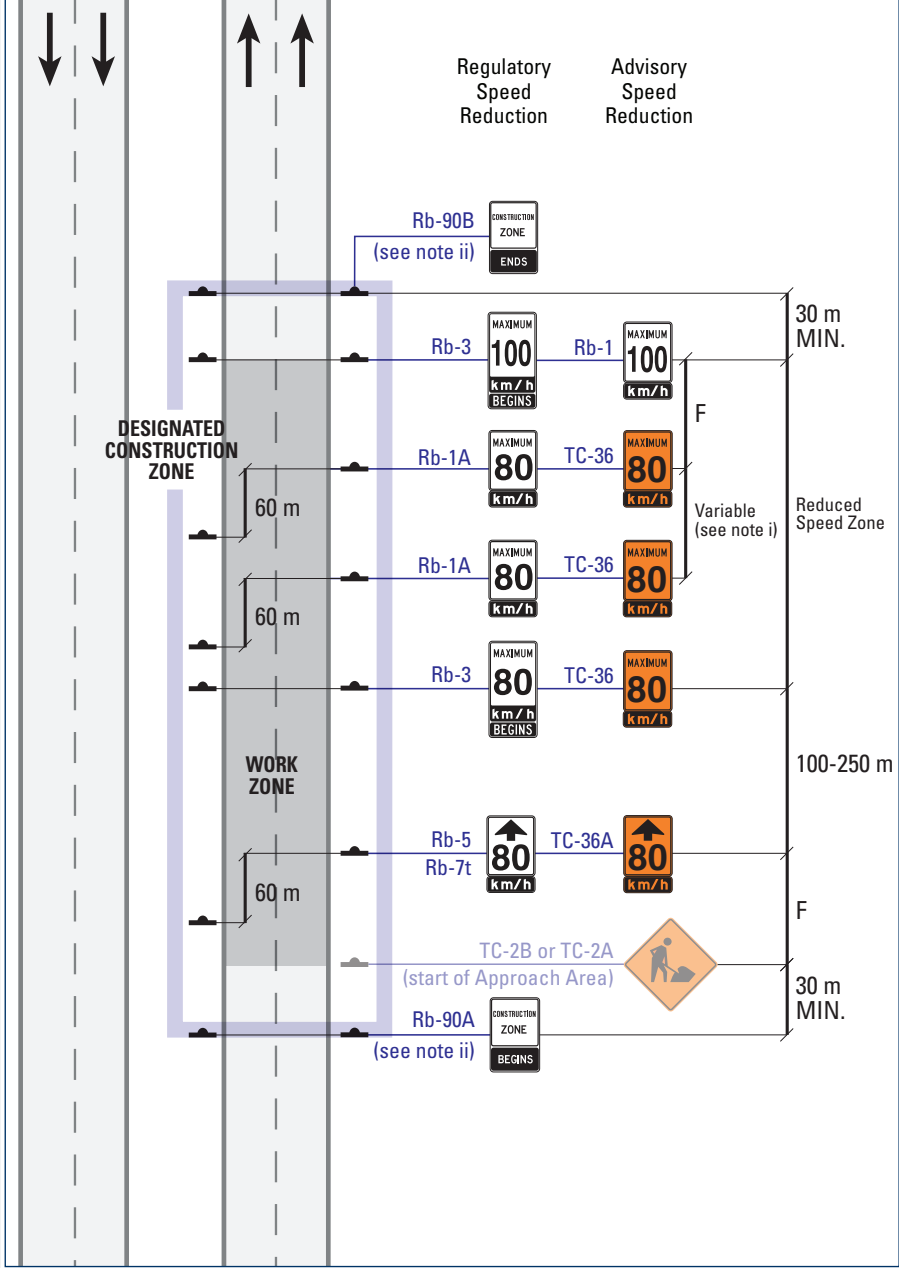

Label	Description	Normal Posted Regulatory Speed (km/h)			
		80	90	100	110
<b>F</b>	Distance between Construction Signs (m)	160	180	200	200

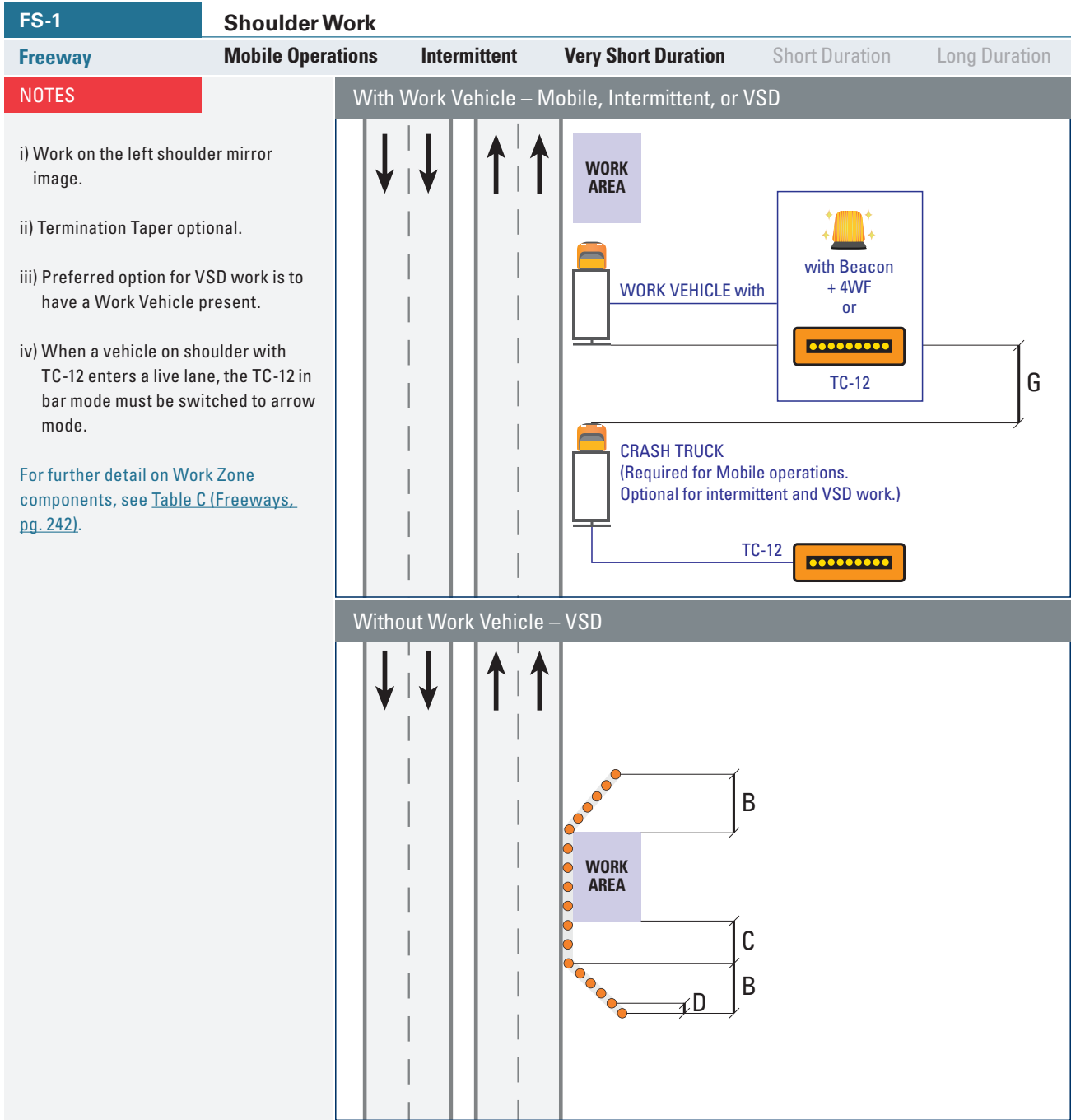

Label	Description	Normal Posted Regulatory Speed (km/h)			
		80	90	100	110
<b>B</b>	Shoulder Taper (m)	75	85	100	100
<b>C</b>	Longitudinal Buffer Area (LBA) (m)	60	75	95	110
<b>D</b>	Maximum Distance between Markers (m)	12	24	24	24
<b>G</b>	Mobile Work: Lateral Intrusion Deterrence Gap (LIDG) (m)	45	50	55	60
<b>G</b>	Stationary Work (Lateral Intrusion Deterrence Gap (LIDG) (m)	60	65	70	75

**FS-2** **Shoulder Work**

**Freeway** Mobile Operations Intermittent Very Short Duration **Short Duration** Long Duration

**NOTES**

i) Work on the left shoulder mirror image.

**For stationary Long Duration operations (longer than five days), Temporary Concrete Barriers must be used to separate the Work Area from traffic.**

For further detail on Work Zone components, see [Table C \(Freeways, pg. 242\)](#).

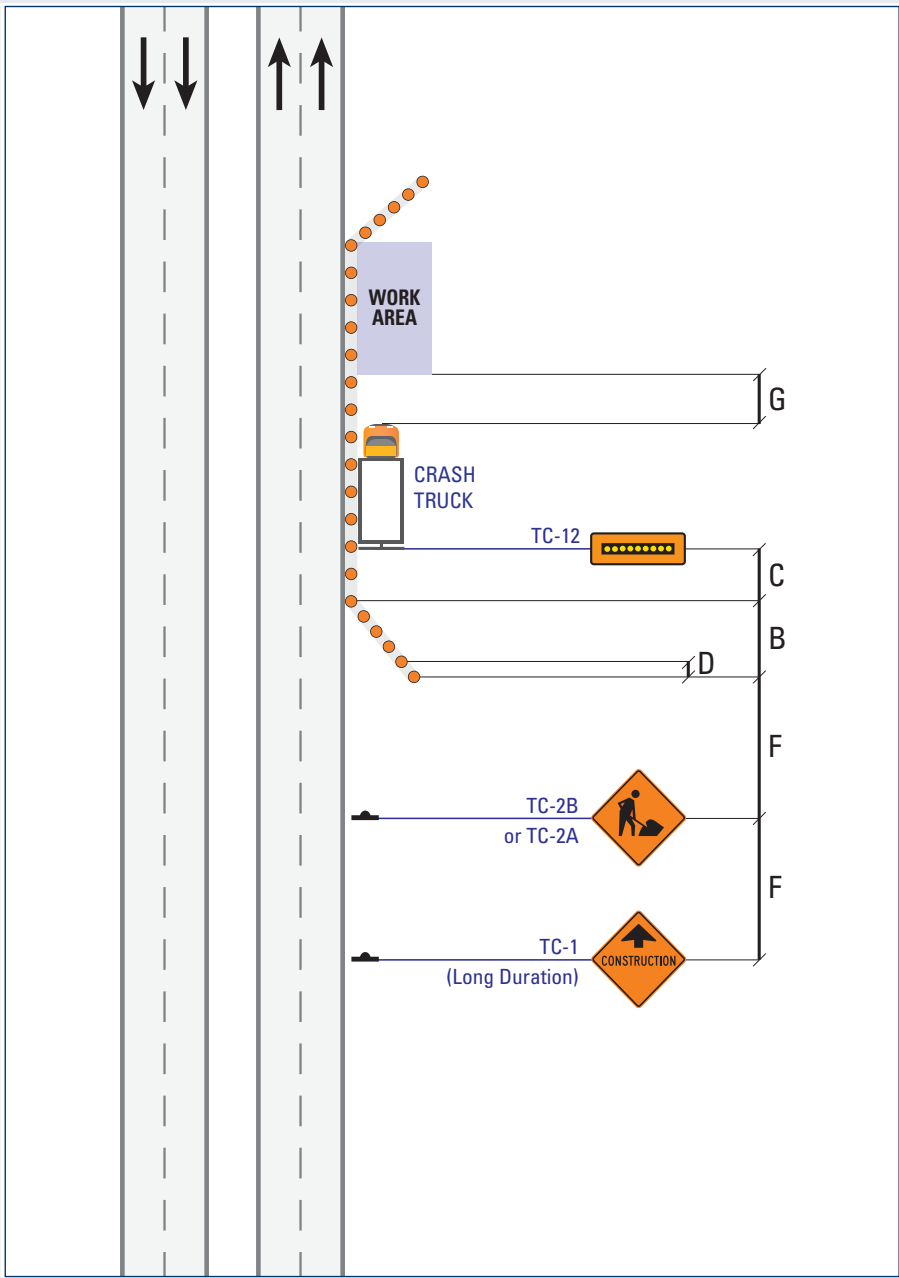

Label	Description	Normal Posted Regulatory Speed (km/h)			
		80	90	100	110
<b>B</b>	Shoulder Taper (m)	75	85	100	100
<b>C</b>	Longitudinal Buffer Area (LBA) (m)	60	75	95	110
<b>D</b>	Maximum Distance between Markers (m)	12	24	24	24
<b>F</b>	Distance between Construction Signs (m)	160	180	200	200
<b>G</b>	Stationary Work (Lateral Intrusion Deterrence Gap (LIDG) (m)	60	65	70	75

**FS-3 Partial Lane Shift: Narrow Lanes**

**Freeway**

Mobile Operations

Intermittent

Very Short Duration

Short Duration

**Long Duration**

**NOTES**

i) Minimum lane width is 3.5 m. Additionally, an offset of 0.3 m to 0.6 m between Markers and the edge of the travelled lane is desirable.

ii) For narrowed lanes exceeding 1 km, use a TC-16EL (ER) in place of the TC-9L (R). Add an additional TC16ER (EL) at the beginning of end Taper.

**For stationary Long Duration operations (longer than five days), Temporary Concrete Barriers must be used to separate the Work Area from traffic.**

For further detail on Work Zone components, see [Table C \(Freeways, pg. 242\)](#).

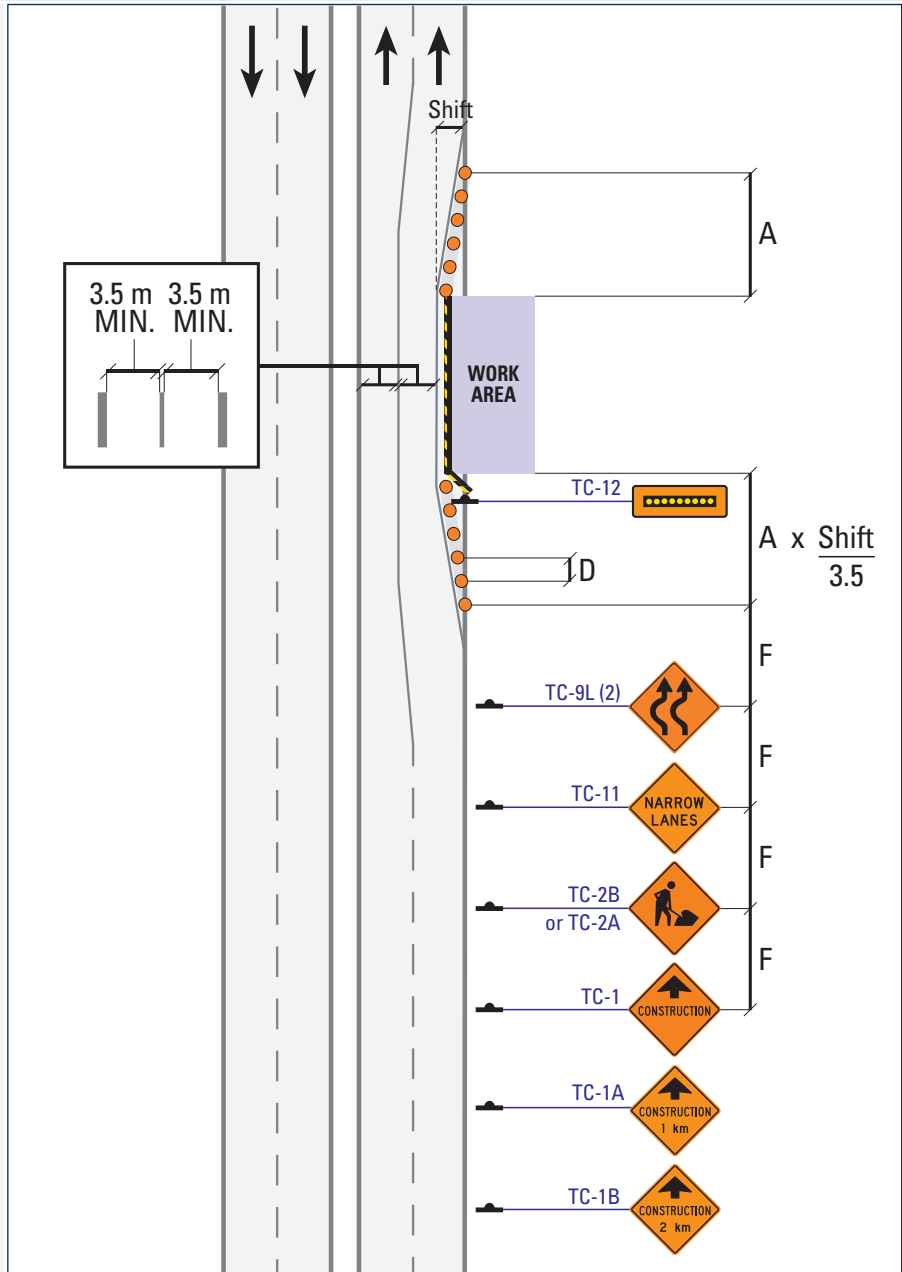

Label	Description	Normal Posted Regulatory Speed (km/h)			
		80	90	100	110
<b>A</b>	Taper Length for Full Lane Closure (m)	220	250	300	300
<b>D</b>	Maximum Distance between Markers (m)	12	24	24	24
<b>F</b>	Distance between Construction Signs (m)	160	180	200	200

**FS-4 Lane Realignment**

**Freeway**      Mobile Operations      Intermittent      Very Short Duration      Short Duration      **Long Duration**

**NOTES**

- i) Refer to OTM Book 6 for the appropriate placement of TC-18L.
- ii) Markers used for additional Delineation through Tangent on the far-side of the Work Area are optional.
- iii) If Temporary Concrete Barriers are used, the Crash Truck is not required.
- iv) TC-1A and TC-1B Advance Warning are required for freeways (not shown).
- v) Work on the right shoulder: mirror image.

**For stationary Long Duration operations (longer than five days), Temporary Concrete Barriers must be used to separate the Work Area from traffic.**

For further detail on Work Zone components, see [Table C \(Freeways, pg. 242\)](#).

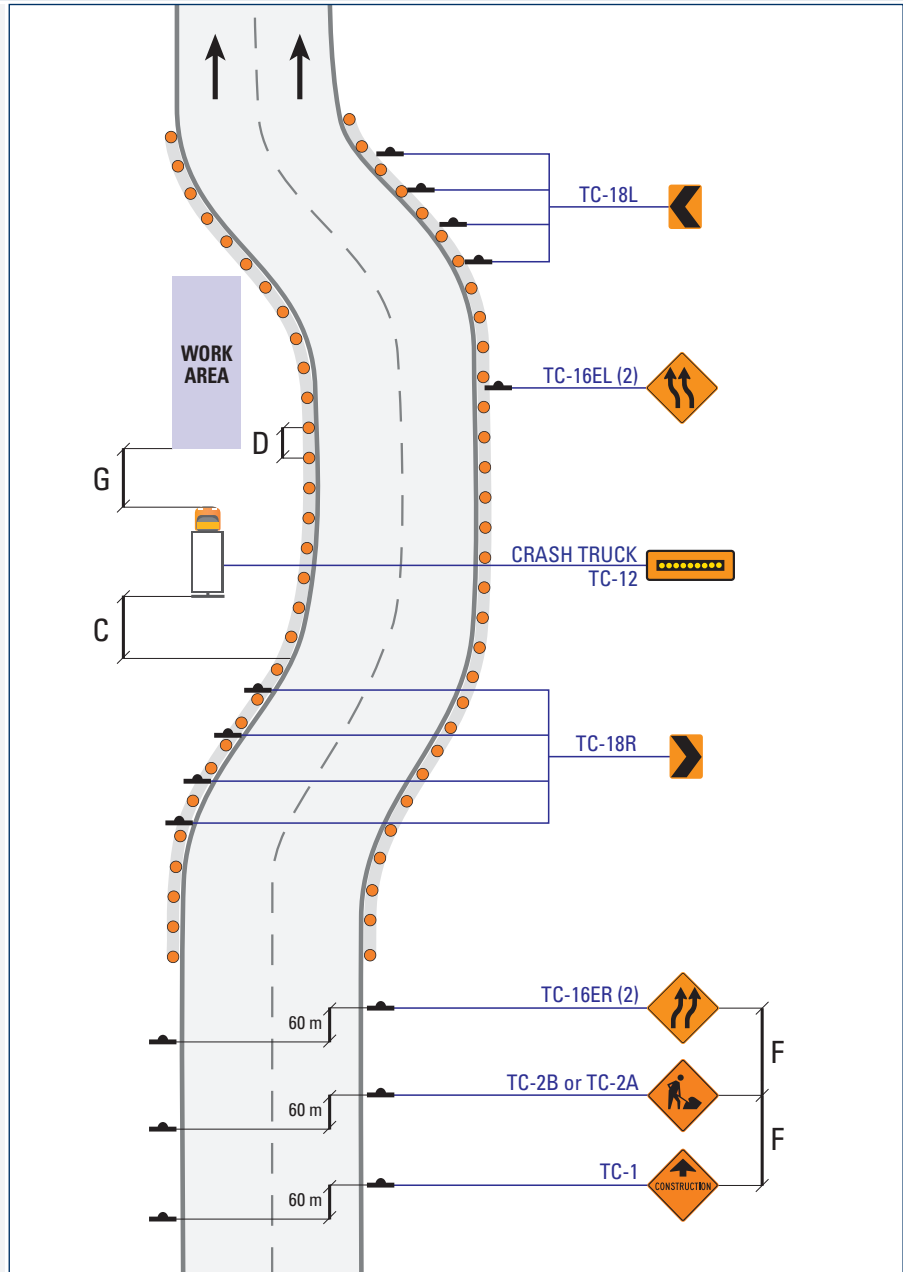

Label	Description	Normal Posted Regulatory Speed (km/h)			
		80	90	100	110
<b>C</b>	Longitudinal Buffer Area (LBA) (m)	60	75	95	110
<b>D</b>	Maximum Distance between Markers (m)	12	24	24	24
<b>F</b>	Distance between Construction Signs (m)	160	180	200	200
<b>G</b>	Stationary Work (Lateral Intrusion Deterrence Gap (LIDG) (m)	60	65	70	75

**FS-5 Zone Painting: Right or Left Lane Closed**

**Freeway**

**Mobile Operations**

Intermittent

Very Short Duration

Short Duration

Long Duration

**NOTES**

- i) MTO requirements illustrated. Other Road Authorities may not require a "ROAD PAINTING" information sign or additional Crash Truck #1.
- ii) Sign Truck may be replaced by an approved equivalent VMS.
- iii) Left Lane Closed: mirror image of Right Lane Closed, where shoulder exists. Where no shoulder or narrow shoulder exists, the Sign Truck must follow on the right shoulder with TC-12 in bar mode with "ROAD PAINTING LEFT LANE CLOSED" sign.
- iv) The distance between Sign Truck and Buffer Vehicle may be adjusted to accommodate hills, curves, restricted visibility, or other specific conditions.
- v) When a vehicle on shoulder with TC-12 enters a live lane, the TC-12 in bar mode must be switched to arrow mode.

For further detail on Work Zone components, see [Table C \(Freeways, pg. 242\)](#).

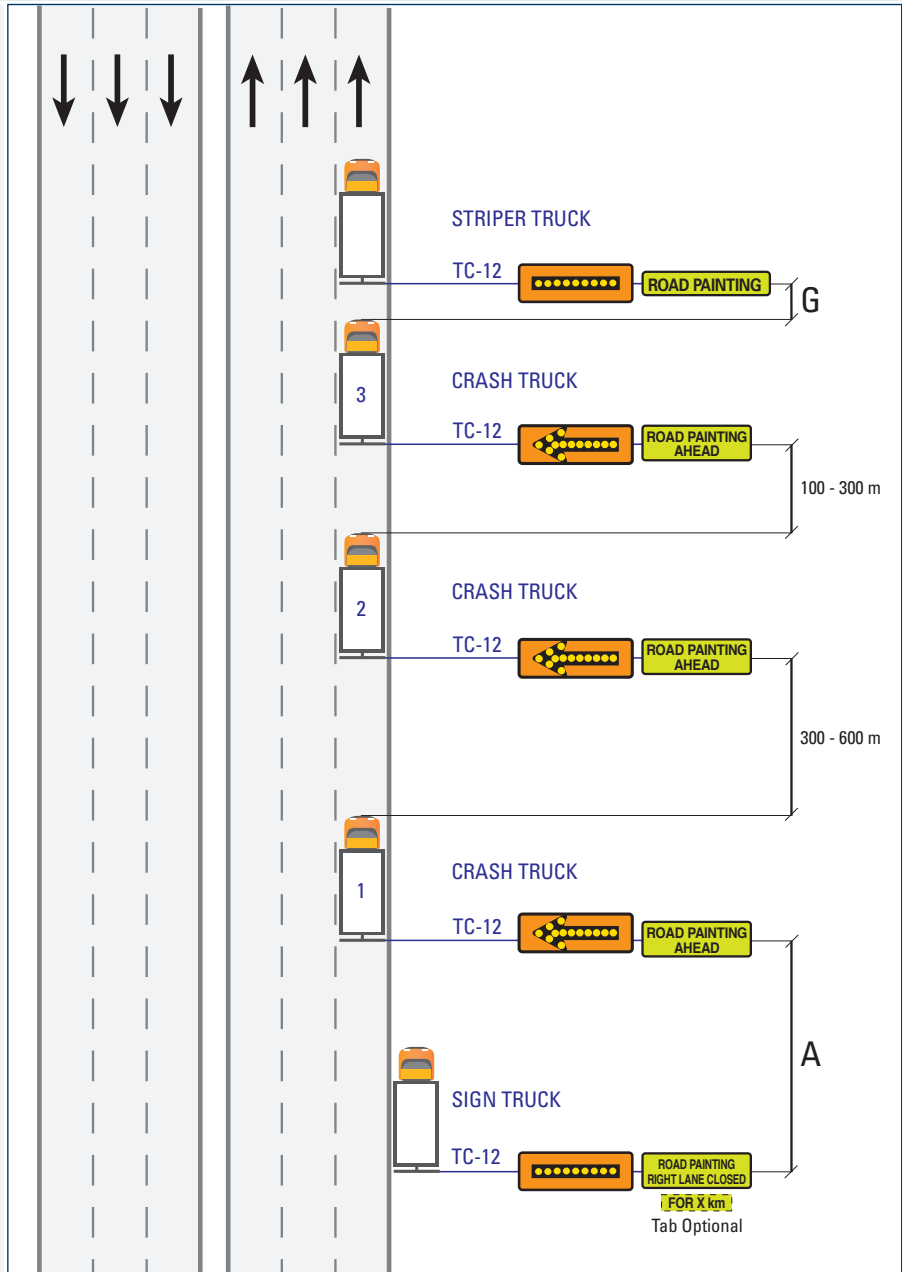

Label	Description	Normal Posted Regulatory Speed (km/h)			
		80	90	100	110
<b>A</b>	Taper Length for Full Lane Closure (m)	220	250	300	300
<b>G</b>	Stationary Work (Lateral Intrusion Deterrence Gap (LIDG) (m)	45	50	55	60

**FS-6 Right or Left Lane Closed or Occupied**

**Freeway**      **Mobile Operations**      Intermittent      Very Short Duration      Short Duration      Long Duration

**NOTES**

i) Distance between Sign Truck and Crash Truck may be adjusted to accommodate hills, curves, restricted visibility, or other site specific conditions.

ii) Left Lane Closed: mirror image of Right Lane Closed, where shoulder exists. Where no shoulder or narrow shoulder exists, Sign Truck may be eliminated. Optionally, modify by replacing the Sign Truck with a Crash Truck with a TC-12 in arrow mode moving behind, in the same lane as the first Crash Truck in bar mode.

iii) When a vehicle on shoulder with TC-12 enters a live lane, the TC-12 in bar mode must be switched to arrow mode.

For further detail on Work Zone components, see [Table C \(Freeways, pg. 242\)](#).

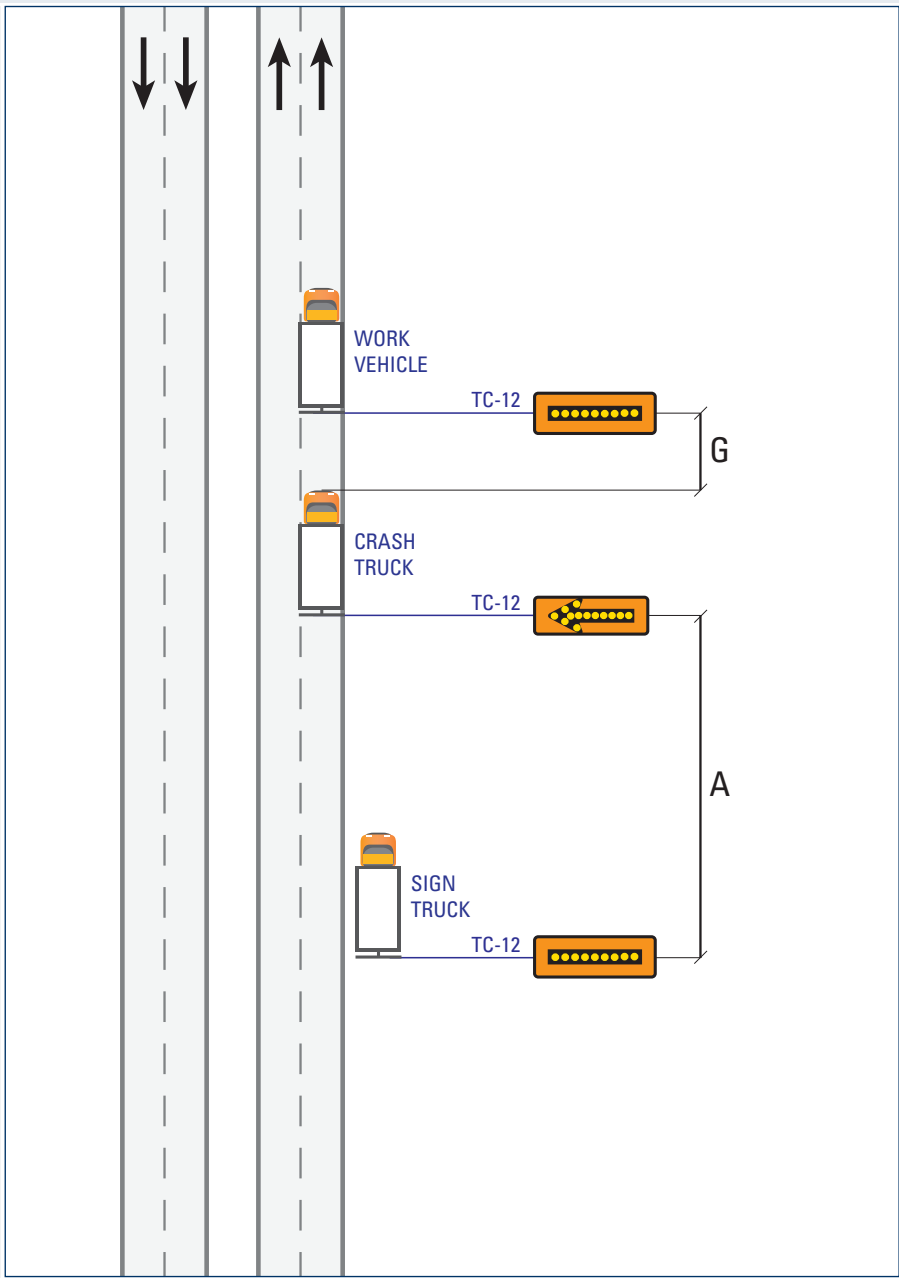

Label	Description	Normal Posted Regulatory Speed (km/h)			
		80	90	100	110
<b>A</b>	Taper Length for Full Lane Closure (m)	220	250	300	300
<b>G</b>	Stationary Work (Lateral Intrusion Deterrence Gap (LIDG) (m)	45	50	55	60



**FS-7 Right or Left Lane Closed**

**Freeway**

Mobile Operations

Intermittent

**Very Short Duration**

Short Duration

Long Duration

**NOTES**

i) The Work Area may include Work Vehicles. All Work Vehicles in the Work Area (downstream of the Crash Truck) with an activated TC-12 must have the TC-12 in bar mode.

ii) Left Lane Closed: mirror image of Right Lane Closed.

iii) For HOV Lane Closure (or other legally limited lane use): lengthen C such that the transition Taper is within the legal access/egress zone, and lengthen Work Area such that exit Taper is within legal access/egress zone. Where not practicable, notify and/or have police present.

For further detail on Work Zone components, see [Table C \(Freeways, pg. 242\)](#).

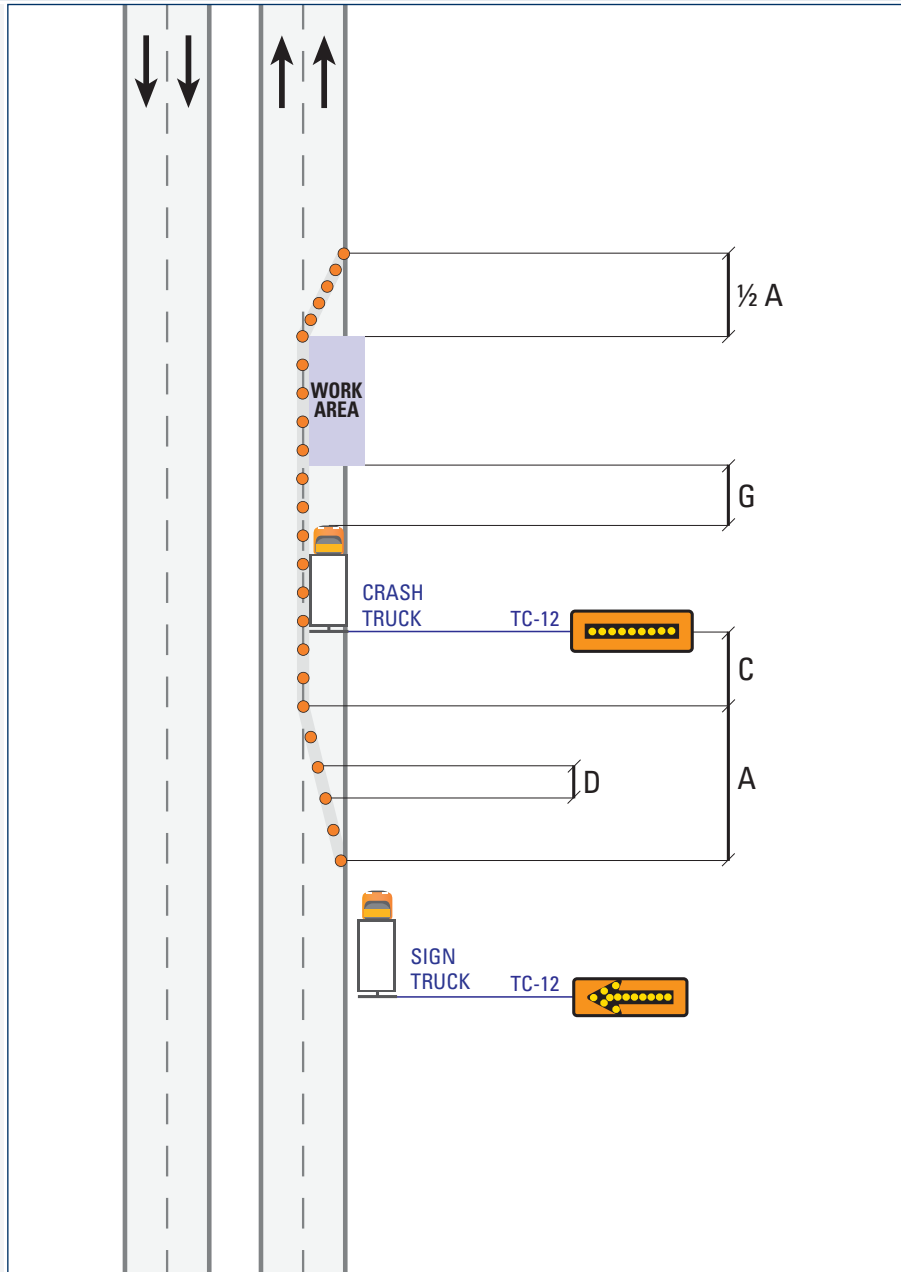

Label	Description	Normal Posted Regulatory Speed (km/h)			
		80	90	100	110
<b>A</b>	Taper Length for Full Lane Closure (m)	220	250	300	300
<b>C</b>	Longitudinal Buffer Area (LBA) (m)	60	75	95	110
<b>D</b>	Maximum Distance between Markers (m)	12	24	24	24
<b>G</b>	Stationary Work (Lateral Intrusion Deterrence Gap (LIDG) (m)	60	65	70	75

**FS-8 Right or Left Lane Closed**

Freeway Mobile Operations Intermittent Very Short Duration Short Duration Long Duration

**NOTES**

- i) Left Lane Closed: mirror image of Right Lane Closed.
- ii) Where signs cannot be accommodated in the median, provide additional signs on the right shoulder.
- iii) The Work Area may include Work Vehicles. All Work Vehicles in the Work Area (downstream of the Crash Truck) with an activated TC-12 must have the TC-12 in bar mode.
- iv) For HOV Lane Closure (or other legally limited lane use): lengthen C such that the transition Taper is within the legal access/egress zone, and lengthen Work Area such that exit Taper is within legal access/egress zone. Where not practicable, notify and/or have police present.

**For stationary Long Duration operations (longer than five days), Temporary Concrete Barriers must be used to separate the Work Area from traffic.**

\*The TC-4 sign must be installed at or just beyond the beginning of a lane closure taper.

For further detail on Work Zone components, see [Table C \(Freeways, pg. 242\)](#).

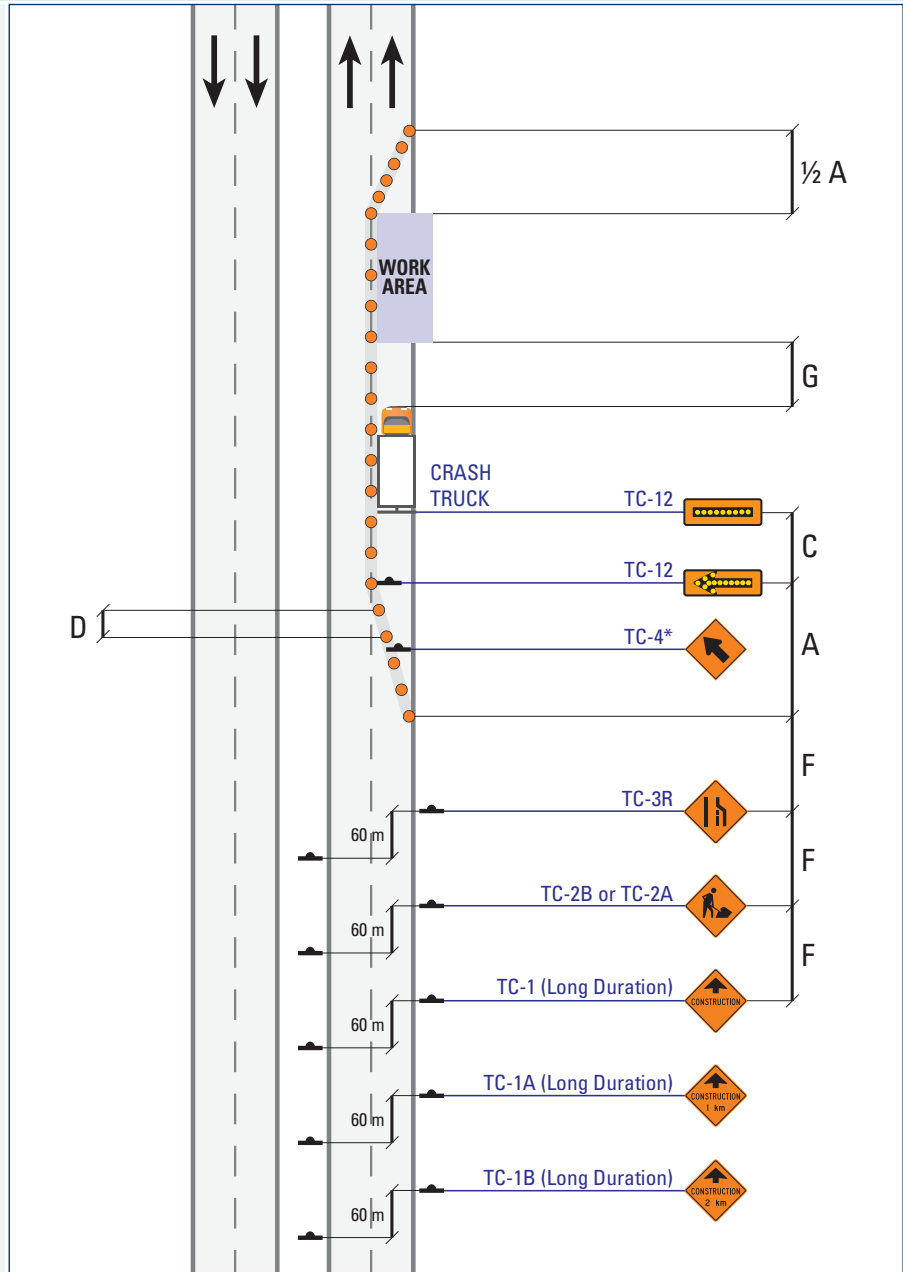

Label	Description	Normal Posted Regulatory Speed (km/h)			
		80	90	100	110
A	Taper Length for Full Lane Closure (m)	220	250	300	300
C	Longitudinal Buffer Area (LBA) (m)	60	75	95	110
D	Maximum Distance between Markers (m)	12	24	24	24
F	Distance between Construction Signs (m)	160	180	200	200
G	Stationary Work (Lateral Intrusion Deterrence Gap (LIDG) (m)	60	65	70	75

**FS-9 Six Lane Road: Centre Lane or Two Lanes Closed**

**Freeway**

Mobile Operations

Intermittent

Very Short Duration

Short Duration

Long Duration

**NOTES**

i) Where signs cannot be accommodated in the median, provide additional signs on the right shoulder.

ii) Left Lane Closed: mirror image of Right Lane Closed.

**For stationary Long Duration operations (longer than five days), Temporary Concrete Barriers must be used to separate the Work Area from traffic.**

\*The TC-4 sign must be installed at or just beyond the beginning of a lane closure taper.

For further detail on Work Zone components, see [Table C \(Freeways, pg. 242\)](#).

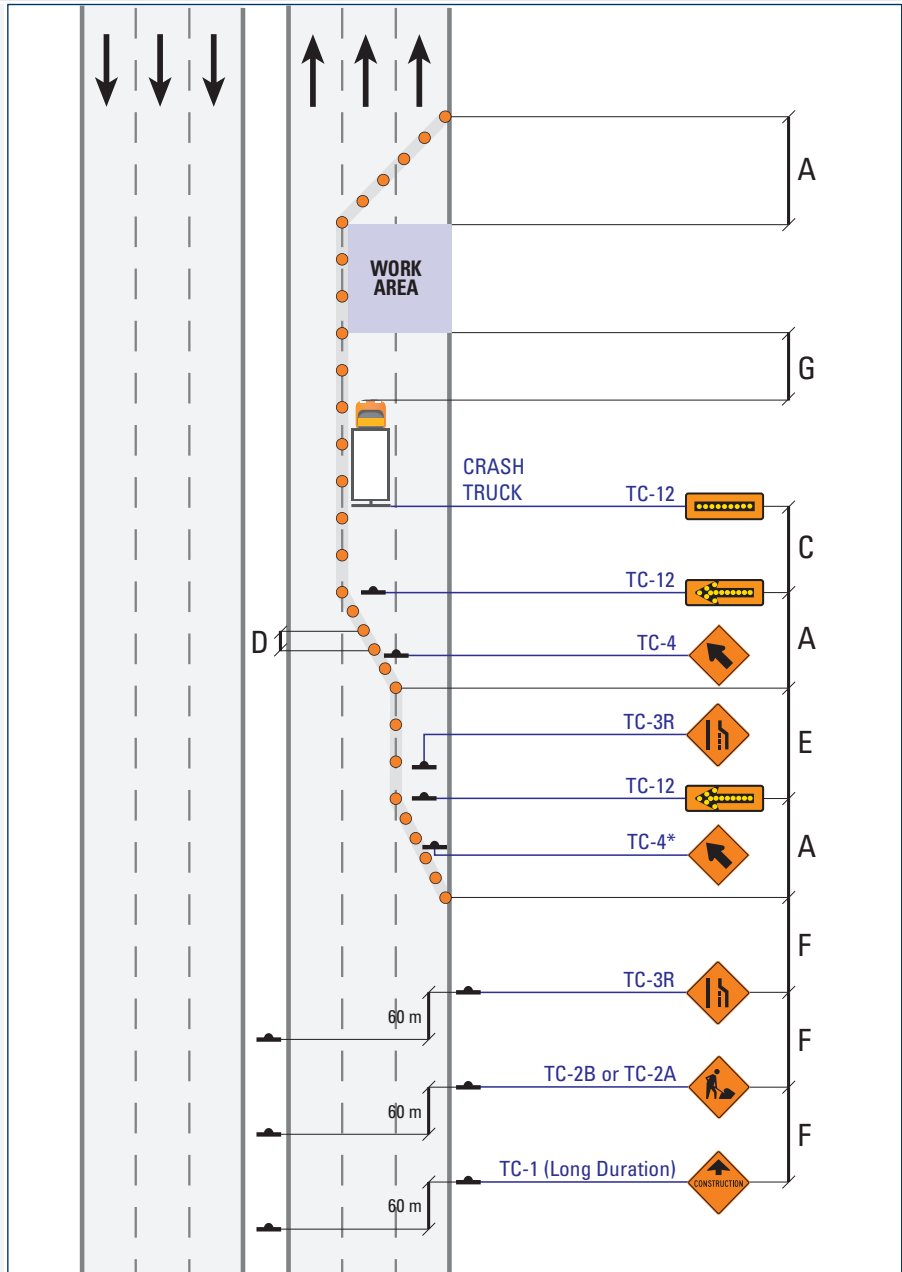

Label	Description	Normal Posted Regulatory Speed (km/h)			
		80	90	100	110
<b>A</b>	Taper Length for Full Lane Closure (m)	220	250	300	300
<b>C</b>	Longitudinal Buffer Area (LBA) (m)	60	75	95	110
<b>D</b>	Maximum Distance between Markers (m)	12	24	24	24
<b>E</b>	Minimum Tangent between Tapers (m)	220	250	300	300
<b>F</b>	Distance between Construction Signs (m)	160	180	200	200
<b>G</b>	Stationary Work (Lateral Intrusion Deterrence Gap (LIDG) (m)	60	65	70	75

**FR-1 Lane Closed at Exit Ramp**

**Freeway**      Mobile Operations      Intermittent      Very Short Duration      **Short Duration**      Long Duration

**NOTES**

i) For Right Lane Closed, see FS-8.

ii) In the immediate area of the exit, Marker spacings of half of those shown on Table C should be used.

**For stationary Long Duration operations (longer than five days), Temporary Concrete Barriers must be used to separate the Work Area from traffic.**

For further detail on Work Zone components, see [Table C \(Freeways, pg. 242\)](#).

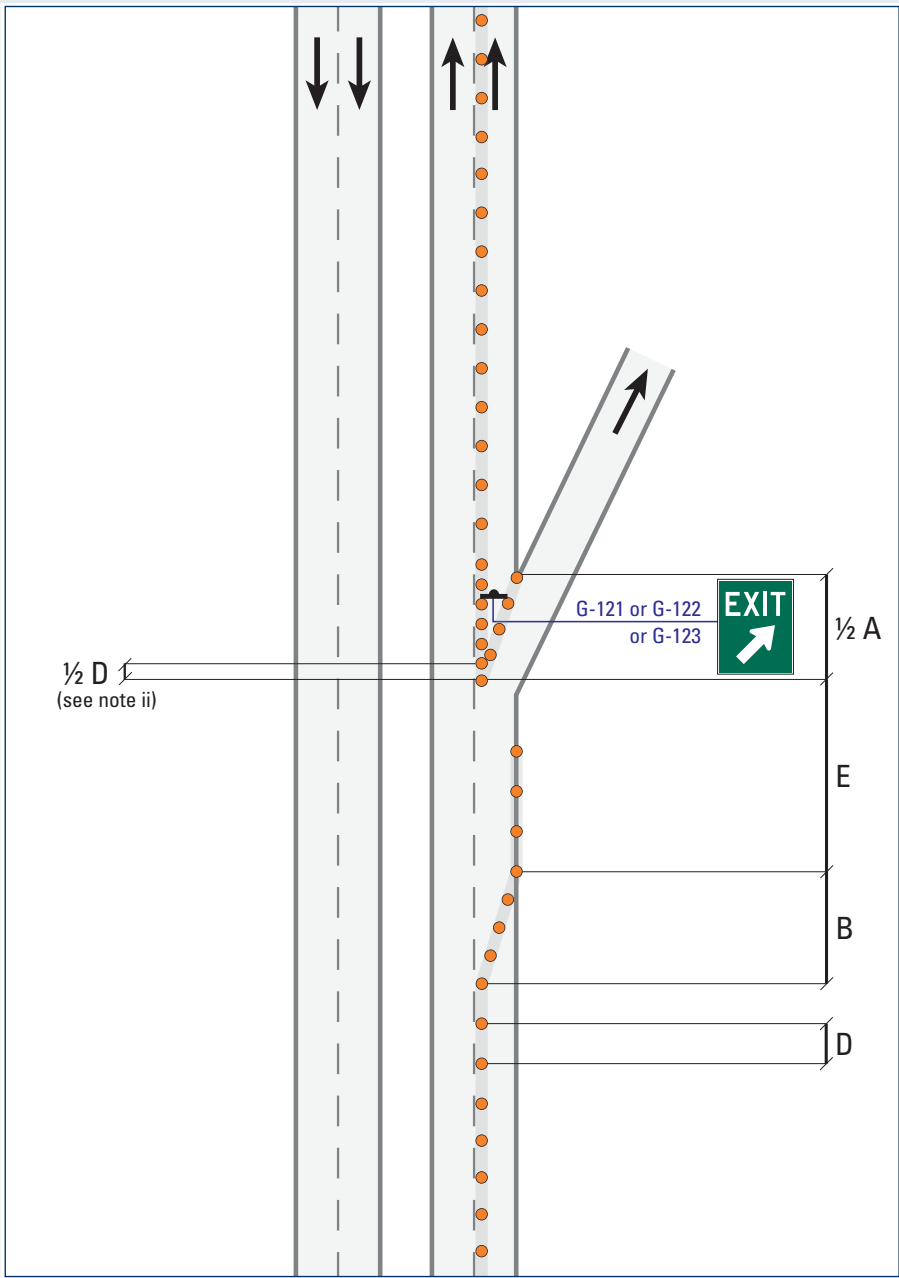

Label	Description	Normal Posted Regulatory Speed (km/h)			
		80	90	100	110
<b>A</b>	Taper Length for Full Lane Closure (m)	220	250	300	300
<b>B</b>	Shoulder Taper (m)	75	85	100	100
<b>D</b>	Maximum Distance between Markers (m)	12	24	24	24
<b>E</b>	Minimum Tangent between Tapers (m)	220	250	300	300

**FR-2 Lane Closed at Exit Ramp with a Deceleration Lane**

**Freeway**

Mobile Operations

Intermittent

Very Short Duration

Short Duration

Long Duration

**NOTES**

- i) For Right Lane Closed, see FS-8.
- ii) In the immediate area of the exit, Marker spacings of half of those shown on Table C should be used.

**For stationary Long Duration operations (longer than five days), Temporary Concrete Barriers must be used to separate the Work Area from traffic.**

For further detail on Work Zone components, see [Table C \(Freeways, pg. 242\)](#).

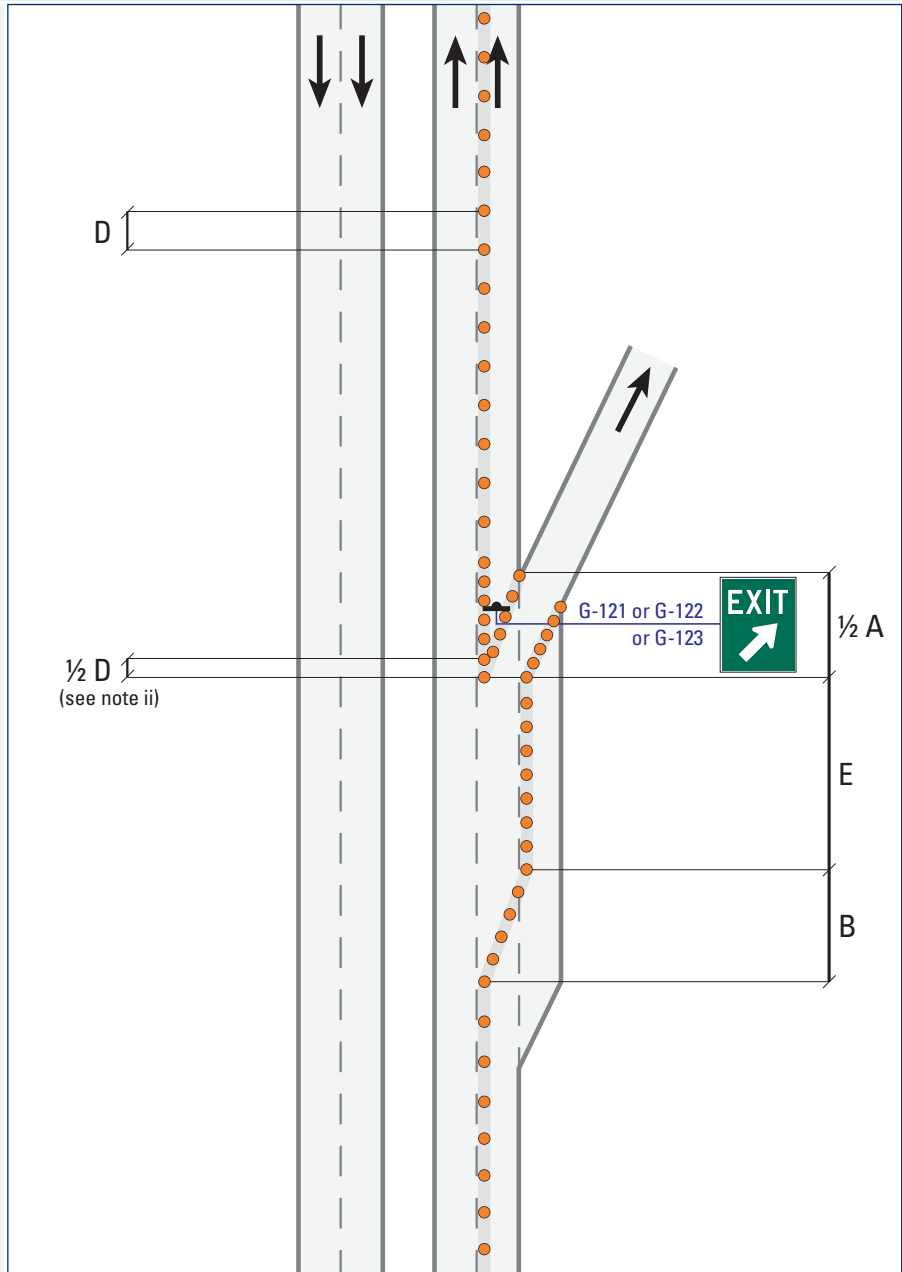

Label	Description	Normal Posted Regulatory Speed (km/h)			
		80	90	100	110
<b>A</b>	Taper Length for Full Lane Closure (m)	220	250	300	300
<b>B</b>	Shoulder Taper (m)	75	85	100	100
<b>D</b>	Maximum Distance between Markers (m)	12	24	24	24
<b>E</b>	Minimum Tangent between Tapers (m)	220	250	300	300

**FR-3 Lane Closed at Entrance Ramp**

Freeway Mobile Operations Intermittent Very Short Duration Short Duration Long Duration

**NOTES**

- i) For Right Lane Closed, see FS-8.
- ii) Where space and work activities permit, the acceleration lane should be made as long as possible.
- iii) In the immediate area of the entrance, Marker spacings of half of those shown on Table C should be used.

**For stationary Long Duration operations (longer than five days), Temporary Concrete Barriers must be used to separate the Work Area from traffic.**

\*The TC-4 sign must be installed at or just beyond the beginning of a lane closure taper.

For further detail on Work Zone components, see [Table C \(Freeways, pg. 242\)](#).

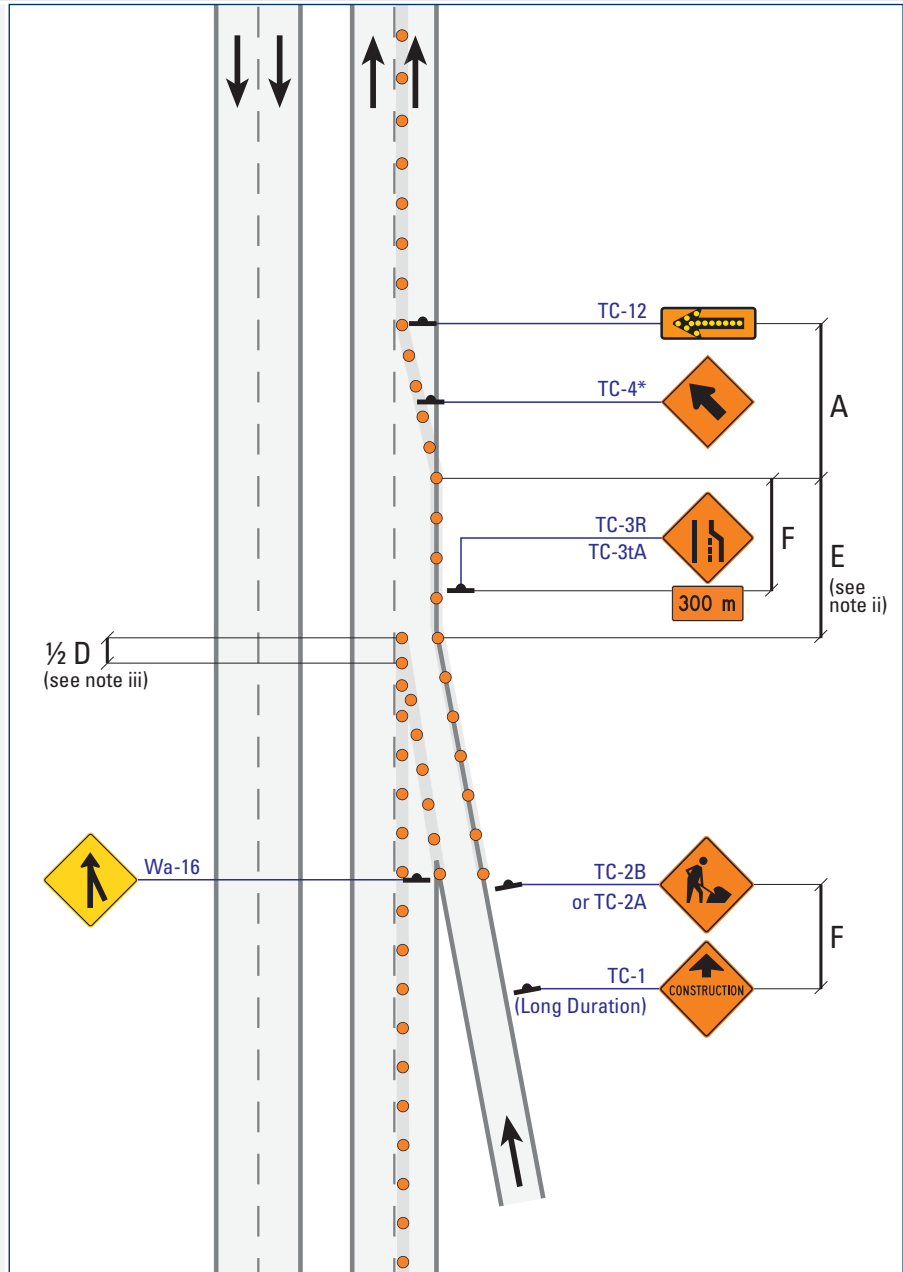

Label	Description	Normal Posted Regulatory Speed (km/h)			
		80	90	100	110
<b>A</b>	Taper Length for Full Lane Closure (m)	220	250	300	300
<b>D</b>	Maximum Distance between Markers (m)	12	24	24	24
<b>E</b>	Minimum Tangent between Tapers (m)	220	250	300	300
<b>F</b>	Distance between Construction Signs (m)	160	180	200	200

**FR-4 Lane Closed at Entrance Ramp with an Acceleration Lane**

**Freeway**

Mobile Operations

Intermittent

Very Short Duration

Short Duration

Long Duration

**NOTES**

- i) For Right Lane Closed, see FS-8.
- ii) Where space and work activities permit, the acceleration lane should be made as long as possible.
- iii) In the immediate area of the entrance, Marker spacings of half of those shown on Table C should be used.

**For stationary Long Duration operations (longer than five days), Temporary Concrete Barriers must be used to separate the Work Area from traffic.**

\*The TC-4 sign must be installed at or just beyond the beginning of a lane closure taper.

For further detail on Work Zone components, see [Table C \(Freeways, pg. 242\)](#).

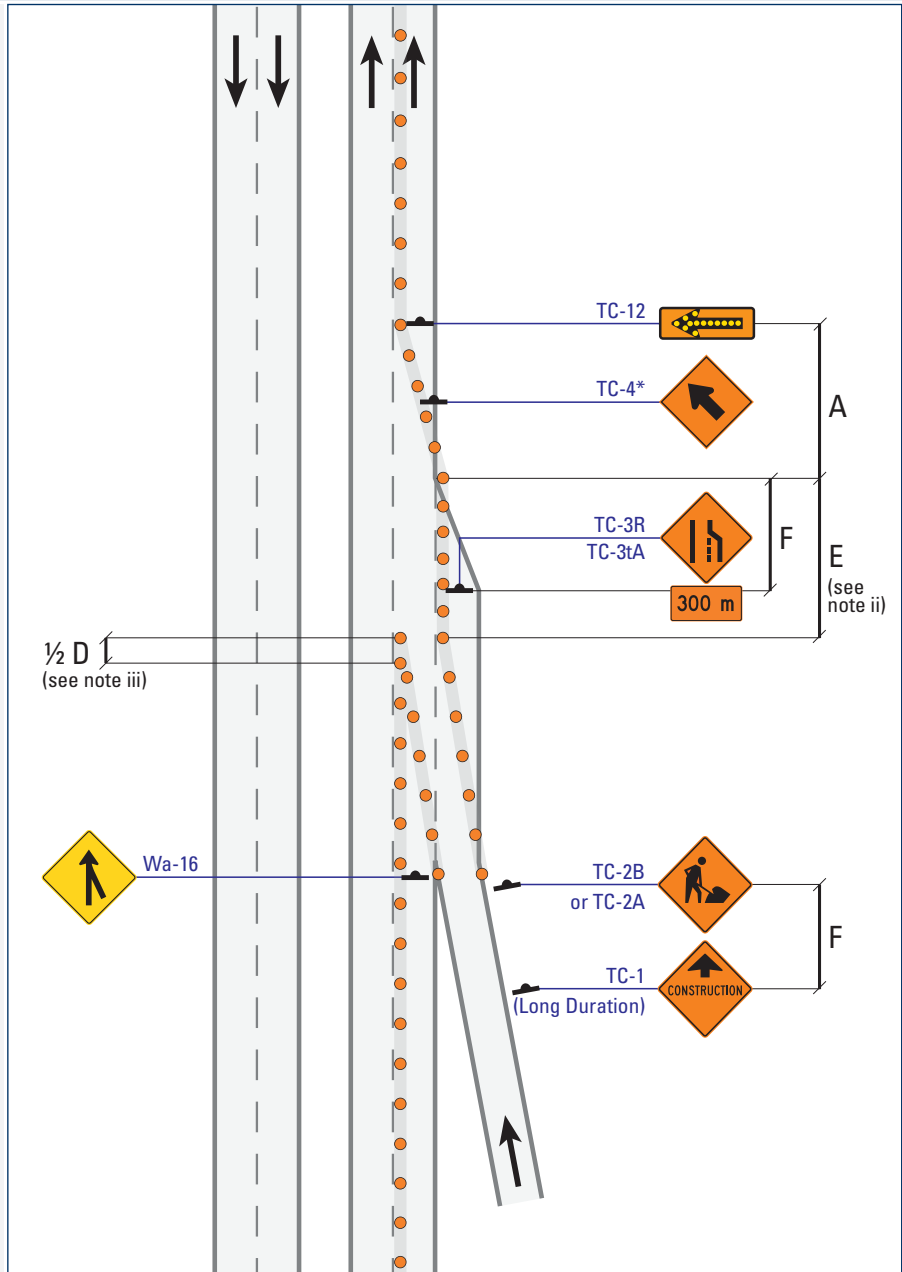

**Normal Posted Regulatory Speed (km/h)**

Label	Description	80	90	100	110
<b>A</b>	Taper Length for Full Lane Closure (m)	220	250	300	300
<b>D</b>	Maximum Distance between Markers (m)	12	24	24	24
<b>E</b>	Minimum Tangent between Tapers (m)	220	250	300	300
<b>F</b>	Distance between Construction Signs (m)	160	180	200	200

**FR-5 Ramp Closed**

Freeway      Mobile Operations      Intermittent      Very Short Duration      Short Duration      Long Duration

**NOTES**

i) Closed sign on Directional Guide Signs to be used for Long Duration only. For details, see OTM Book 8.

ii) See Section 4.3 of the Office Edition for location of TC-64.

**For stationary Long Duration operations (longer than five days), Temporary Concrete Barriers must be used to separate the Work Area from traffic.**

For further detail on Work Zone components, see [Table C \(Freeways, pg. 242\)](#).

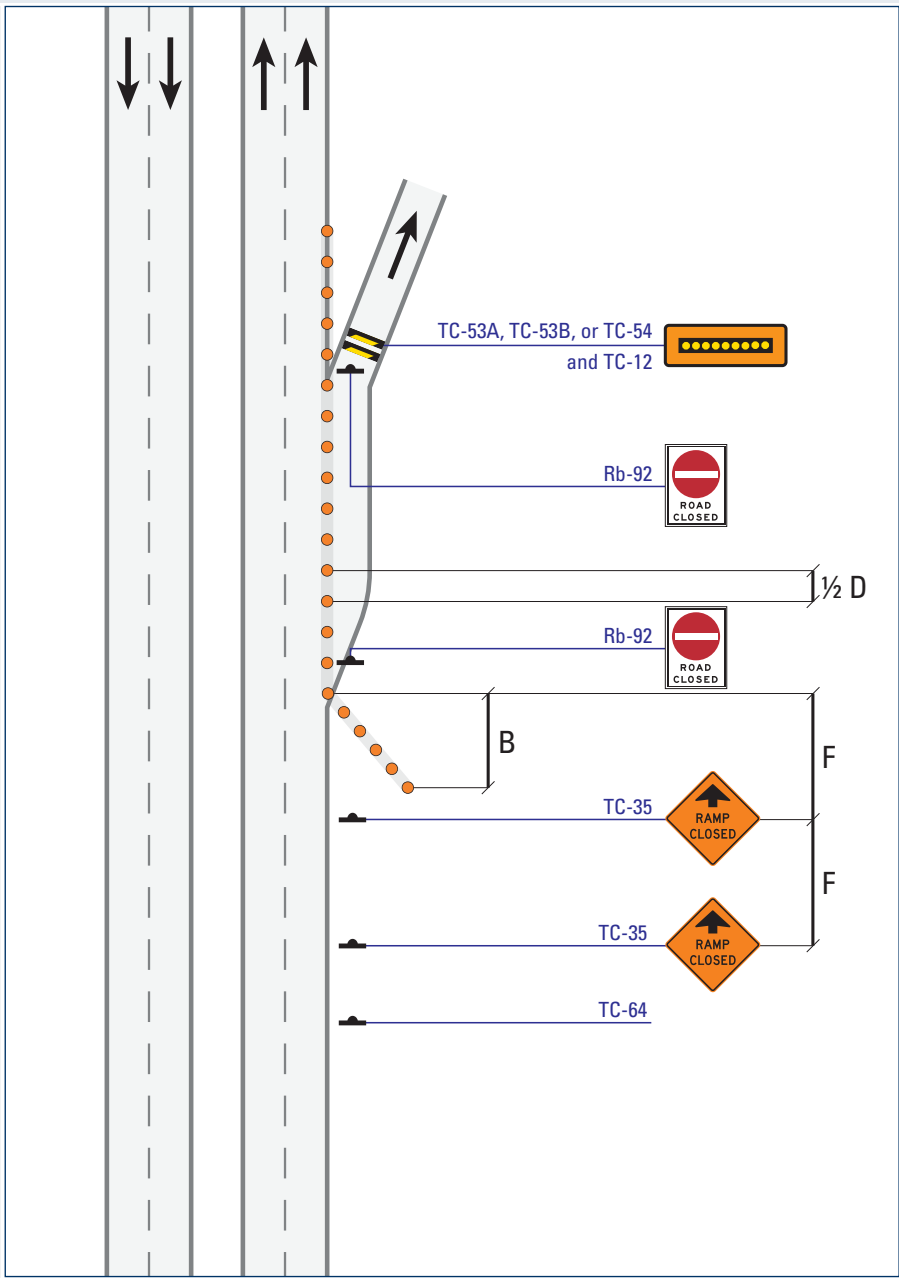

Label	Description	Normal Posted Regulatory Speed (km/h)			
		80	90	100	110
<b>B</b>	Shoulder Taper (m)	75	85	100	100
<b>D</b>	Maximum Distance between Markers (m)	12	24	24	24
<b>F</b>	Distance between Construction Signs (m)	160	180	200	200



**FR-6 Right Developed Lane Closed**

**Freeway**

Mobile Operations

Intermittent

Very Short Duration

Short Duration

Long Duration

**NOTES**

i) Left Developed Lane Closed: mirror image of Right Developed Lane Closed.

**For stationary Long Duration operations (longer than five days), Temporary Concrete Barriers must be used to separate the Work Area from traffic.**

For further detail on Work Zone components, see [Table C \(Freeways, pg. 242\)](#).

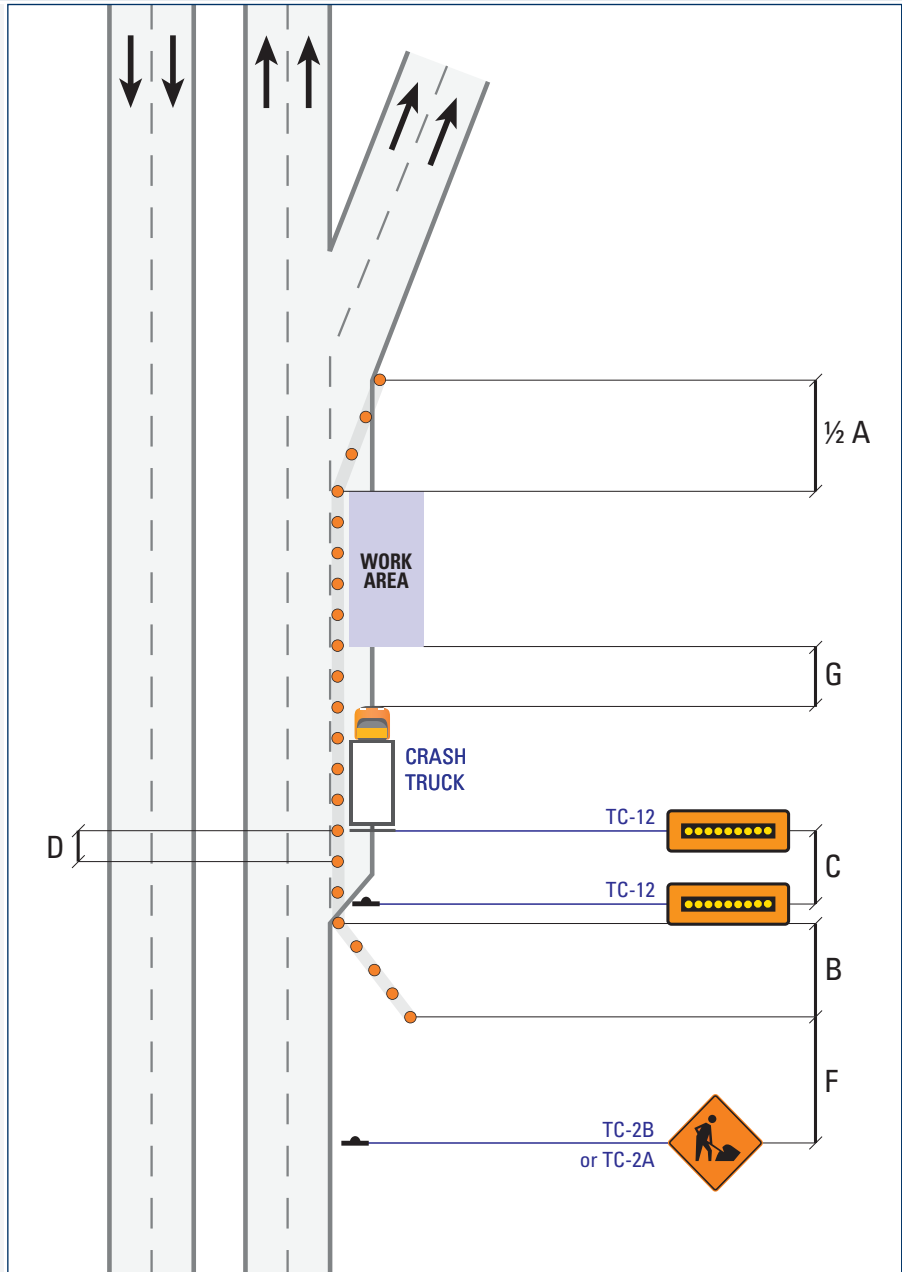

Label	Description	Normal Posted Regulatory Speed (km/h)			
		80	90	100	110
<b>A</b>	Taper Length for Full Lane Closure (m)	220	250	300	300
<b>B</b>	Shoulder Taper (m)	75	85	100	100
<b>C</b>	Longitudinal Buffer Area (LBA) (m)	60	75	95	110
<b>D</b>	Maximum Distance between Markers (m)	12	24	24	24
<b>F</b>	Distance between Construction Signs (m)	160	180	200	200
<b>G</b>	Stationary Work (Lateral Intrusion Deterrence Gap (LIDG) (m)	60	65	70	75

**A****Appendix A: Temporary Traffic Control for Unplanned Events**

---

**A.1 Introduction**

---

Appendix A: Temporary Traffic Control for Unplanned Events is a general guidance for all audience. Hence, each road authority should have specific policies in place, including trainings, for unplanned events and emergency responses.

**A.1.1 Scope**

---

Traffic control is one component of incident management at an unplanned event. Traffic control is the element that:

- Helps to secure the scene.
- Protects other highway users.
- Provides responders with the opportunity to safely deploy necessary actions.

Appendix A provides guidelines to responders on:

- Recommended personal protective equipment (PPE).
- Traffic control devices.
- Progressive staging of traffic control with typical set up procedures.

The guidelines are based on [Section 3.1 Fundamental Principles of Work Zone Design](#) of OTM Book 7. Users should be familiar with both Appendix A and Section 3 as a reference.

The information provided is directed toward:

- Operations personnel.
- First and secondary responders who are responsible for establishing, maintaining, monitoring, modifying, and removing any traffic control at an incident scene or other unplanned event.

[Table A.1](#), below, identifies typical responders and their roles and responsibilities for traffic control.

Table A.1 Typical Responders to Unplanned Events

Response Agency	Roles and Responsibilities Regarding Traffic Control
<b>911 and other Dispatchers</b>	<ul style="list-style-type: none"> <li>• Receive 911 calls from land lines, cell phones, and call boxes.</li> <li>• Dispatch appropriate response agencies.</li> </ul>
<b>Law Enforcement (Provincial, Regional, and Municipal police departments)</b>	<ul style="list-style-type: none"> <li>• Assist in incident detection and verification.</li> <li>• Determine severity of incident and relay information to dispatchers.</li> <li>• Isolate and secure incident scene.</li> <li>• Set up initial traffic control devices.</li> <li>• Determine additional personnel/equipment needed to be called in.</li> <li>• Scene clearance.</li> <li>• Direct traffic.</li> <li>• Identify requirements for crash investigations.</li> </ul>
<b>Fire Rescue (full-time, composite, and volunteer fire departments)</b>	<ul style="list-style-type: none"> <li>• Protect and contain incident scene.</li> <li>• Assist in direction of traffic.</li> <li>• Provide initial dangerous goods response and/or request additional clean-up resources.</li> <li>• Assist in incident clearance.</li> </ul>
<b>Emergency Medical Services (EMS)</b>	<ul style="list-style-type: none"> <li>• Protect and contain incident scene when first on scene.</li> <li>• Determine destination and transportation requirements for the injured.</li> <li>• Coordinate evacuation with firefighters, police, ambulance staff, or airlift personnel.</li> <li>• Transport incident victims.</li> </ul>
<b>Ministry of Transportation or Municipal Road Authority Personnel (or agent)</b>  <b>– Maintenance</b>	<ul style="list-style-type: none"> <li>• Assist in incident detection and verification.</li> <li>• Provide initial and longer-term traffic control.</li> <li>• Provide special equipment or resources as requested.</li> <li>• Provide cleanup and maintenance of damaged highway infrastructure.</li> <li>• Contain minor spills, if possible.</li> <li>• Coordinate with law enforcement regarding alternate routes.</li> <li>• Coordinate personnel resources.</li> <li>• Assess infrastructure damage.</li> <li>• Assist in incident scene clearance.</li> <li>• Supervise site remediation and re-opening.</li> </ul>

Response Agency	Roles and Responsibilities Regarding Traffic Control
<p><b>Ministry of Transportation or Municipal Road Authority Personnel (or agent)</b></p> <p>– Traffic Operations</p>	<ul style="list-style-type: none"> <li>• Assist in incident detection and verification, communicate with emergency services.</li> <li>• Operate Intelligent Transportation System (ITS) devices per approved response plans.</li> <li>• Provide traveler information to public and media, such as estimated time length for closure.</li> <li>• Allocate and dispatch service patrols.</li> <li>• Notify other agencies of incident, as required.</li> </ul>
<p><b>Ministry of Transportation or Municipal Road Authority Personnel (or agent)</b></p> <p>– Construction</p>	<ul style="list-style-type: none"> <li>• Similar duties as maintenance personnel, but within a work zone.</li> <li>• Coordinate with contractor for traffic control and repairs.</li> </ul>
<p><b>Towing and Recovery</b></p>	<ul style="list-style-type: none"> <li>• Assist with incident detection and verification.</li> <li>• Secure incident scene if no encroachment into live lane.</li> <li>• Assist with and relocate disabled vehicles.</li> <li>• Provide containment of minor spills.</li> <li>• Clear the scene.</li> </ul>

**NOTE**  
 Appendix A is a general guidance and each road authority should have specific policies in place for unplanned events and emergency responses.

### A.1.2 Definition of Unplanned Events

Temporary traffic control for construction, maintenance, or scheduled activities, although unique to each location, allows for planning, documentation, and application of the fundamental principles detailed in OTM Book 7.

An unplanned event refers to any incident that occurs without advance notice of time and location which disrupts normal traffic flow and/or presents a hazard to highway users. An unplanned event requires prompt scene management by all responders. Unplanned events include, but are not limited to, the following situations:

- Unplanned infrastructure maintenance such as watermain breaks, fallen poles or signs, bridge/highway washout.
- Vehicle(s)/highway user collision, medical emergencies.
- Vehicle breakdown/fires.

**NOTE**  
 An unplanned event refers to any incident that occurs without advance notice of time and location which disrupts normal traffic flow and/or presents a hazard to highway users.

- Debris on highway - those from nature, objects, spills (including dangerous goods).
- Environmental Safety Hazards (i.e. severe snow, rain, fog).
- Off-highway incidents that affect traffic (i.e. impaired visibility due to fire and smoke located off-highway).
- Pedestrian involved incidents.
- Police investigation not involving an active collision scene.
- Informal and unplanned demonstrations such as protest acts.

### A.1.3 Traffic Control Guidelines

---

It is extremely difficult to establish a clearly defined traffic control zone under emergencies or other unplanned conditions, especially upon arrival. The securing of a scene takes time, and set up should be a progressive activity based on:

- Personnel.
- Equipment.
- Critical needs of the incident.

On-scene traffic control needs can dynamically change as the response efforts progress. See [Table A.2 Progression of Traffic Control](#).

The first priority upon arrival is to establish initial traffic control that provides a safe work area for responders and the public and minimizes the chance of secondary crashes.

Traffic control device placement is impacted by:

- Expected duration of the incident.
- Location.
- Prevailing traffic conditions (i.e., volume, speed).
- Weather and visibility.

Upon arrival, responders should make an estimate of:

1. The magnitude of the incident, then:
2. The expected duration for recovery.

Traffic control can then be progressively established based on this estimate. A preferred sequence would go from:

1. Full highway closure, to
2. Directional lane closure, to

3. Multiple lanes, to
4. Single lane, and to
5. Shoulder closure until the incident is fully resolved and traffic flow returns to normal.

**Lane Closures**

- The initial closure should only be as required to ensure protection of the scene. For example, if only multiple lanes need to be closed, the progressive set up should start from Point 3, above.
- Highway lane closure must be managed so that only the lanes that are necessary to protect the responders, victims, and investigation are closed. Every effort should be made to minimize the amount of time that these lanes are closed.
- The number of closed lanes may change several times during clearance efforts, so traffic control needs to be established and then monitored/changed to fit changing conditions. This should be a coordinated approach between all response agencies as the locations and timelines are affected (i.e., relocation of traffic control devices and resources).
- As resources with traffic control devices/equipment arrive, traffic control should be adjusted to work towards an OTM Book 7 compliant format.

**Table A.2 Progression of Traffic Control**

<b>Upon Arrival</b>	<ol style="list-style-type: none"> <li>1. At any incident where there is encroachment into a live traffic lane, only person(s) qualified under the Highway Traffic Act (HTA) can provide temporary traffic control. If not already present, the appropriate police agency and/or road authority shall be notified that traffic control is required. All other response vehicles shall park in a safe location until initial traffic control is established.</li> <li>2. Ensure all emergency lights are operating as you approach the scene.</li> <li>3. Conduct an initial scene survey to identify hazards and evaluate the situation.</li> <li>4. Begin the establishment of an emergency traffic control zone by slowly coming to a stop and positioning the emergency response vehicle to provide initial safety to the scene.</li> <li>5. All personnel who leave emergency vehicles must wear appropriate high-visibility safety apparel at a minimum. This includes all responders, regardless of duties in the emergency traffic control zone. Some road authorities and agencies will have higher standards of PPE use than the minimum requirements.</li> </ol>
<b>Initial Set up</b>	<ol style="list-style-type: none"> <li>6. When practicable, place cones and/or flares to form an initial taper with devices on hand.</li> <li>7. Position additional responder vehicles to enhance establishment of traffic control zone or direct to park in an appropriate location.</li> </ol>

<b>Initial Set up</b>	8. If required, call for additional resources to secure the scene (i.e., road authority, “safety support vehicle”, additional traffic control devices, etc.).
<b>Enhanced Traffic Control</b>	9. Place appropriate advisory signs in the advance warning area as soon as possible. 10. Expand taper and cone placements for highway conditions and estimated on-scene time. 11. If required, utilize appropriate person(s) to direct traffic on non-freeways and other available traffic control devices, including the use of ramp closure gates.
<b>Ongoing Traffic Control</b>	12. When an extended duration scene of more than two hours is anticipated, additional traffic control devices shall be provided as shown in OTM Book 7 for a planned event of the expected duration (short duration (SD) or long duration (LD)). 13. All safety procedures must remain in place until the incident is terminated (all personnel, hazards, emergency and related vehicles, and equipment are removed from the highway).

## A.1.4 Unified Command

Command needs to be established from the first arriving responder at an incident or unplanned event.

The responsibility of the Incident Commander is to:

- Stabilize the environment.
- Stabilize the scene.
- Stabilize any patients before beginning operations.
- Provide potential ingress and egress routes for responding units.

Depending on the availability of emergency responders, the typical first arriving responder may vary between jurisdictions. As well, the Incident Commander may change among the first responders as the incident progresses. For example:

<b>Incident Situation</b>	<b>Appropriate Incident Commander</b>
1. Medical treatment is required for patients where no extrication is required and there is no risk of fire (or other safety hazards, but significant resources are required to transport the injured parties).	EMS
2. Extrication is required or there is risk of a fire.	Fire Department
3. Patient(s) stabilized or transported from the scene, or the fire extinguished. Focus of command changes to perimeter safety of all parties and expediting traffic flow.	Police

**NOTE**

It is recommended that first responder organizations within a jurisdiction develop an incident command protocol.

## A.2 Guidelines for First on Scene

### A.2.1 Identification of Hazards and Scene Evaluation

The first responder to an unplanned event should conduct an initial scene survey to identify site specific hazards and evaluate the situation.

Placement of vehicles and traffic control devices will be impacted by the unique conditions of each scene. The purpose of traffic control is to:

- Provide protection to responders and the public.
- Provide guidance to highway users.

Any potential hazards to responders or highway users should be identified, and traffic control adjusted accordingly.

Hazards that may affect traffic control include:

- Poor visibility due to weather.
- Limited/obstructed sight lines – hills, curves, trees, signs, etc.
- Increased highway user reaction time required due to highway conditions – wet, icy, snow covered.
- Impact of highway type – gravel, paved, current surface conditions.
- Prevailing traffic characteristics – observed speed, volume, percent of heavy vehicles.
- Impacts from type or level of lighting – artificial illumination (night), sun direction, dusk/dawn.
- Potential impending environmental impacts – debris, chemical leak, etc.
- Estimated on-scene time.

**NOTE**

Any potential hazards to responders or highway users should be identified, and traffic control adjusted accordingly.

### A.2.2 Estimated On-Scene Time – Extended Duration Scene

The first responder to an unplanned event should:

- Make an estimate of the expected on-scene time.
- Determine the adequacy of the resources on hand (vehicles, cones/flares, personnel) to maintain traffic control for the entire duration and various stages of the event.



- Request additional resources as soon as practicable.

Extended duration scenes are typically traffic incidents that involve:

- Dangerous goods.
- Fatal traffic crashes that involve numerous vehicles.
- Other natural or human-made disasters.

Extended duration scene traffic incidents typically involve the closure of all or part of a highway facility for a period that exceeds two hours.

#### NOTE

Extended duration scene traffic incidents typically involve the closure of all or part of a highway facility for a period that exceeds two hours.

Examples include:

- Chain reaction crashes.
- Crashes that require a significant medical response, coroner response, and/or crash reconstruction response (e.g., fatalities).
- Incidents that involve advanced, prolonged environmental cleanup (e.g., incidents that involve dangerous goods).
- Incidents that involve structural damage to highway infrastructure.
- Incidents that involve a mass evacuation. A mass evacuation could lead to prolonged incident response in areas outside of the immediately affected zone.
- Wildfires near the highway.

If an extended duration scene is anticipated, additional equipment, vehicles, and personnel must be called in to provide temporary traffic control as per OTM Book 7.

### A.2.3 Lane Closure and Traffic Direction

Under the HTA, only the following are permitted to close a live lane(s) and/or direct traffic.

- Police.
- Firefighters.
- Road authority.

If first on scene, EMS responders should block lanes effectively closed by the incident as required, to protect the incident area until additional responders arrive.

At any incident where there is encroachment into a live traffic lane, if not already present:

- The appropriate police agency and/or road authority shall be notified that traffic control is required.

- All other response vehicles, such as service and/or tow vehicles shall park in a safe location until initial traffic control is established.

## A.3 Equipment and Devices

---

### A.3.1 High Visibility Safety Apparel

---

All employers must ensure that all workers who are exposed to the hazards of passing traffic are wearing High Visibility Safety Apparel (HVSA) appropriate for the circumstances.

All emergency responders, including secondary support, shall wear HVSA if they are:

- Setting up/removing traffic control devices.
- Directing traffic.
- Working within three metres of a live lane.

#### **Occupational Health and Safety Act (OHSA):**

Consistent with the General Duty under Section 25(2)(h) of the OHSA:

- Employers are required to take every precaution reasonable in the circumstances to protect workers.
- Employers of emergency first responders engaged in various non-construction type activities e.g., police, fire, ambulance, are responsible for conducting an assessment of traffic hazards to determine which type of high visibility garments are appropriate.

The Construction Projects regulation requires that:

- Any worker who may be endangered by vehicular traffic on a project must wear a garment that covers the upper body and provides a high level of visibility.
- Some specifics of that garment can be found In Section 69.1 of O.Reg. 213/91 of the OHSA. For example, if the garment is a vest, it must have an adjustable fit and a side and front tear-away feature. This regulation specifies the performance criteria (i.e., chromaticity/luminance) for the required background material, front and back stripes, or silver nighttime stripes for arms, legs, or sides.

#### **High Visibility Requirements:**

Canadian Standards Association (CSA) Standard Z96-15, American National Standard ANSI/ISEA 107-2015, or European National Standard EN-471 (EN ISO 20471: 2013) may be used to:

- Establish reasonable performance criteria for high visibility garments to protect workers on a case-by-case basis.

- Provide recommendations for the selection of appropriate HVSA and sets out performance criteria for high visibility garments.

The CSA’s current standard (CSA Z96-15) for high visibility safety apparel classifies HVSA by the extent of body coverage:

- Class 3 - greatest body coverage and visibility under poor light conditions and at great distance.
- Class 2 - moderate body coverage and superior visibility.
- Class 1 - lowest recognized coverage and good visibility.

The selection of apparel class is dependent on a case-by-case scenario based on the level of risk associated with the task. [Table A.3](#) outlines some example scenarios of when each class of HVSA may be applicable.

**Table A.3 Scenario Examples of Appropriate HVSA Class Selection Based on Risk Level**

Level of Risk	Applicable HVSA Class	Examples of Situations	Examples of Jobs
Low Risk	Class 2 or Class 1 (not recommended)	<ul style="list-style-type: none"> <li>• When vehicles are moving slowly (e.g., less than 40 km/h).</li> <li>• Worker’s activities permit a continuous consciousness of approaching traffic.</li> <li>• When there is ample separation between the worker on foot and the traffic.</li> <li>• When work backgrounds are not complex, allowing for optimal visibility.</li> </ul>	<ul style="list-style-type: none"> <li>• Workers directing vehicle operators to parking or service locations.</li> <li>• “Right-of-Way” or sidewalk maintenance workers.</li> </ul>
Medium Risk	Class 2 or Class 3	<ul style="list-style-type: none"> <li>• When vehicles or equipment are moving between 40-80 km/h.</li> <li>• When workers are performing tasks that divert attention from approaching vehicle traffic.</li> <li>• When work activities are in closer proximity to vehicles (in or near flowing vehicle traffic).</li> </ul>	<ul style="list-style-type: none"> <li>• Roadway construction, utility, or railway workers.</li> <li>• Survey crews.</li> <li>• School crossing guards.</li> <li>• Parking and/or toll gate workers.</li> </ul>

Level of Risk	Applicable HVSA Class	Examples of Situations	Examples of Jobs
<b>Medium Risk (continued)</b>	<b>Class 2 or Class 3</b>	<ul style="list-style-type: none"> <li>When work backgrounds are complex.</li> <li>Workers who require greater visibility under inclement weather conditions or low light.</li> </ul>	<ul style="list-style-type: none"> <li>Emergency response personnel.</li> <li>Members of law enforcement.</li> <li>Collision site investigators.</li> </ul>
<b>High Risk</b>	<b>Class 2 for daytime or Class 3 for low-light conditions</b>	<ul style="list-style-type: none"> <li>When vehicle speeds exceeding 80 km/h.</li> <li>Workers on foot and vehicle operators with high task loads that clearly place the worker in danger.</li> <li>When the worker must be conspicuous through the full range of body motions at a minimum of 390 m.</li> <li>Work activities taking place in low light or at nighttime.</li> </ul>	<ul style="list-style-type: none"> <li>Roadway construction, utility, or railway workers.</li> <li>Survey crews.</li> <li>Emergency responders.</li> <li>Road assistance/courtesy patrols.</li> <li>Flagging crews.</li> <li>Towing operators.</li> </ul>

**NOTE**  
 For emergency responders, CSA Class 2 or 3 HVSA should be used, within the limitations of the equipment necessary to perform their duties.

For emergency responders, CSA Class 2 or 3 HVSA should be used, within the limitations of the equipment necessary to perform their duties. For details on the exact specifications of size, coverage, fit, brightness, design, colour, care, and maintenance, reference to CSA Standard Z96-15 is highly recommended.

Typically, first responder uniforms do not meet the OHS/A requirement. Hence, while on the highway, their uniforms should be supplemented with an appropriate PPE. For example, most Fire Fighter bunker gear does not meet the reflectivity performance requirements of CSA Standard Z96-15 High-Visibility Safety Apparel. Therefore, firefighter(s) who are controlling traffic using traffic control STOP or SLOW signs are required to wear high visibility safety apparel while performing this work.

Personnel working within a safe zone established by blocker apparatus or police shall wear safety vests. Personnel wearing self-contained breathing apparatus or other specialized PPE such as Hazmat suits do not require safety vests but must be protected within a safe zone established by blocker apparatus or police.

High Visibility garments that comply with the previous CSA Z96-09 standard are considered acceptable if in good condition, however, when old high visibility garments are replaced, they should be replaced with high visibility garments that meet the current CSA Z96-15 standard.

The following resources may be able to assist workplace parties and raise awareness about the hazards associated with work activities on/near highways:

- Public Services Health and Safety Association.
- Infrastructure Health and Safety Association.
- Workplace Safety and Prevention Services.
- Workplace Safety North.
- HSO - Health & Safety Ontario.

### A.3.2 Vehicle Lights and Flares

---

Flashing lights on emergency response vehicles are used to enhance the safety of response personnel and incident victims and are essential in the initial response stage. They may be:

- Red, white, amber, blue, and/or green in colour.
- Capable of high intensity rotating and/or light emitting diode (LED) wigwag, oscillating, or strobe.
- Mounted outside as well as inside.

Flashing lights on emergency response vehicles provide visibility and give immediate information to the travelling public of an emergency. Use of flashing lights must comply with the Highway Traffic Act (HTA).

Too many warning lights can be confusing to drivers. Flashing lights should be used with discipline and discretion to minimize the impact on traffic flow. As practicable, it is recommended that once good traffic control is established at the incident scene, their use should be reduced such that:

- Only amber, rather than red/blue, warning lights remain on once full OTM Book 7 compliant traffic control is in place. If deemed necessary due to visibility issues, such as fog, red/blue lights may be continued.
- The number of lights is minimized to avoid creating glare for motorists and reduce “rubber necking” behavior.
- No (or minimal) forward-facing (into oncoming traffic) emergency lighting is occurring. Emergency response vehicles should be capable of turning off headlights when the responder determines necessary.
- Emergency response vehicles should have day and night settings for vehicle lights.

- Tow vehicle beacons are deactivated once no longer needed to protect workers or public, i.e., after the vehicle is travelling with the traffic stream without a vehicle in tow.
- Appropriate incident commander should establish and communicate which lights should be used to effectively minimize the use of warning lights.

**Use of Flares:**

In addition to the use of emergency vehicle placement as an initial traffic control set up, responders should carry enough emergency flares which can be used to set up a temporary lane closure taper until other efforts, such as traffic cones, can be placed.

Flares, or other illuminated warning devices, are especially useful in low light and reduced visibility conditions to:

- Warn motorists of lane changes, as the bright red lights of the flares tend to visually merge.
- Supplement the visibility of traffic cone placement under night conditions. When flares are placed near cones, they not only warn upstream traffic, but the light also illuminates the cones.

E-flares are a recommended alternative to “disposable” flares as they are not left at the scene.

**A.3.3 Emergency Signs**



First responders may carry flexible, roll-up signs with the EMERGENCY SCENE AHEAD message or directional arrow that can be set up quickly at an incident site using portable lightweight spring stands or other appropriate temporary mounting.

The purpose of the signs is to:

- Alert drivers that the temporary traffic control is a result of an emergency situation.
- Alert drivers to expect responders on the highway.
- Alert drivers to proceed with caution as full temporary traffic control may not yet be established.



The EMERGENCY SCENE AHEAD signs should be placed on the shoulder of a highway by a qualified first responder (fire, enforcement, or the road authority or their agent) in advance of the incident scene.

At an unplanned event, responders have competing priorities, therefore, the following guidelines should be undertaken, as practicable.

#### **Guidelines for Placement of Emergency Signs:**

- EMERGENCY SCENE AHEAD signs should be placed to provide enough warning for vehicles to slow down before reaching the incident scene. For situations near a corner, hill, or other reduced visibility situations, may require the location of advance warning devices to be adjusted.
- Incidents on high speed (over 80 km/h) divided highways (freeways) should have warning signs placed, as practicable, approximately 160 metres in advance of the beginning of the taper. Signs should be placed on the shoulder, 2.0 metres from the edge of the travelled lane.
- Warning signs on other highways should be placed approximately 20 metres in advance of the taper for speeds 60 km/h or less and 70 metres in advance of the taper for speeds above 60 km/h. Signs should be placed on the shoulder 0.3 metres to 2.0 metres from the edge of the travelled lane.
- The directional arrow sign should be placed by a qualified first responder (fire, enforcement, or the road authority or their agent) in advance of the incident scene, at the beginning of the taper where the highway user is required to navigate around an incident.
- Warning and guide signs used for the incident management of emergency traffic situations should have black lettering and a black border on a fluorescent pink background. The fluorescent pink background should be restricted to emergency warning signs only.

### **A.3.4** Traffic Cones

---

Traffic cones are used as channelizing devices and to alert highway users to hazards in or near the travelled way.

#### **Guidelines for the Use of Cones during Unplanned Events:**

- Cones should provide a smooth and gradual transition in moving traffic from one lane to another, into a detour, or in reducing the width of the travelled way.
- Channelizing devices may also be used to separate traffic from the incident area.
- Where possible, they should be set 0.3 metres to 0.6 metres back from the edge of a live traffic lane.
- The standard cone is the TC-51B (700 mm) with a white reflective collar.
- The TC-51C with a white reflective collar is an acceptable alternative

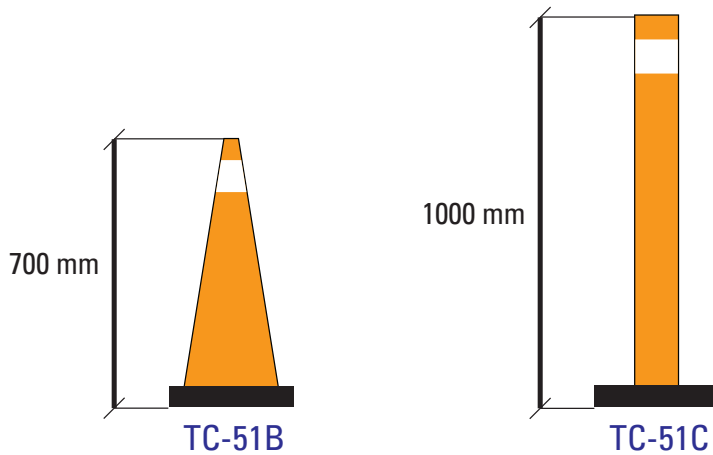

- The white reflective cone collar must be 100 mm to 150 mm wide, mounted on the upper one-third of the cone taper, 100 mm below the top of the cone or marker (Type III or IV, high intensity reflective sheeting).
- The TC-51A (450 mm) may be used when larger cones are not available; however, cones should have sufficient weight to withstand wind gusts.

- Flashing beacons (visible 360°) or flares may be used in conjunction with cones to outline traffic set ups, especially the lateral buffer, and are highly recommended during low light and reduced visibility conditions.
- On high speed freeways, lane closures should be accomplished with vehicles (that have appropriate lighting and flashing arrow board sign) rather than just using cones.

Guidance on the placement of cones is provided in [Section A.4](#).

### A.3.5 Manual Traffic Direction

Manual traffic direction may need to be provided by qualified trained personnel such as a Traffic Control Person (TCP) during the initial phase of the response. Normally, the TCP is one of the responding law enforcement personnel, however, manual traffic direction could also be provided by the fire or road authority (or agent). TCP may be used to guide traffic when:

- Travel lanes are partially blocked.
- The shoulder must be used to pass by the incident.
- Only one lane is available for two-way traffic.

TCP may only be used when the normal posted speed is 90 km per hour or less.

**Guidelines for Manual Traffic Direction:**

- The person directing traffic must always face the traffic, wear the appropriate HVSA, and direct traffic away from and safely around the incident by using large, extended, and consistent gestures to convey the required actions to drivers.
- Where available, STOP/SLOW paddles (TC-22) or a flashlight with a red or orange cone attachment (traffic baton) are preferred for directing traffic. (Refer to Section 4 in OTM Book 7 for more details on procedures for manual traffic direction).



- When resources permit, a traffic spotter may be utilized to monitor traffic and activate an emergency signal if the actions of a motorist do not conform to established traffic control measures in place at the incident scene. (The use of a portable air horn or similar device is suggested as an emergency signal).

### A.3.6 Other Available Traffic Control Devices

---

#### **Variable Message Signs**

Variable Message Signs (VMS), either portable or those permanently placed at critical major decision points of a highway system, can be used to provide notice and information such as alerting motorists in advance of the incident of:

- Lane changes.
- Available alternate routes.
- Detours.
- Expected delays.

The earlier the information can be provided, the greater the opportunity to reduce traffic demand at, and approaching, the scene as well as reduce motorist frustration.

While the VMS text capability is limited, this form of communication is very effective. Information relayed can include:

- Specific incident location.
- Expected incident duration.
- Alternate route details.
- Diversion directions including non-standard motorist actions such as, driving on the shoulder.

#### **Flashing Arrow Board Signs**

Flashing arrow board signs (TC-12 or TC-12A) are additional traffic control devices used where a lane(s) is closed, and traffic must merge with other traffic in an adjacent lane. These devices are brought to an incident scene at a later stage, as full compliancy with Temporary Traffic Control in OTM Book 7 is established.

Some road authorities and emergency responders mount flashing arrow board signs on their work vehicles to provide guidance to road users and to support traffic control.

**Guidelines for Use of Flashing Arrow Board Signs:**

- Flashing arrow board signs should conform to the specifications for TC-12 or TC-12A as provided in [Section 4](#) in OTM Book 7 to ensure visibility and consistent messaging.
- Flashing arrow board signs that do not comply with TC-12 or TC-12A should be considered only supplemental, with sufficient additional traffic control devices provided to guide the highway user.
- Some devices have the capacity to not only display arrows, but also text and other symbol messages such as PVMS. Responders must receive training in the actual operational requirements of flashing arrow board signs, as well as in developing appropriate message sets to fully utilize the available board functions at the incident scene.

**Crash Trucks**

Heavy trucks or trailers with rear-mounted energy adsorption attenuation equipment become a traffic control device, or Crash Truck (CT), when parked to protect a work zone or incident area.

**Guidelines for Use of Crash Trucks:**

- The CT should be placed upstream from the incident work space with the wheels angled slightly away from the incident area and live traffic.
- The CT should be unoccupied as its purpose is to protect the work area by taking any hit before an errant vehicle can enter the zone where people may be otherwise be unprotected.
- The use of a CT must comply with Section 4 in OTM Book 7.

**Safety Support Vehicle**

Risks increase on highways with a posted speed of 70 km/h or greater. Therefore, on any highway with a posted speed of 70 km/h or greater, a Support Vehicle should be dispatched along with the primary response vehicles.

A Support Vehicle can be any emergency vehicle; however, vehicles equipped with designated traffic control devices should be utilized first.

The Support Vehicle functions as a warning device to oncoming motorists by blocking a lane or parking on the shoulder. Personnel who operate a support vehicle may be required to:

- Assist crews on scene.
- Outline the perimeter of the incident scene or secure the site.
- Set up any additional required safety equipment.
- Establish traffic space and monitor traffic flow.
- Block additional traffic lanes as required.

## A.4 Placement of Cones/Flares

### A.4.1 Taper, Buffers and Incident Area

Figure A.1 Placement of Cones/Flares

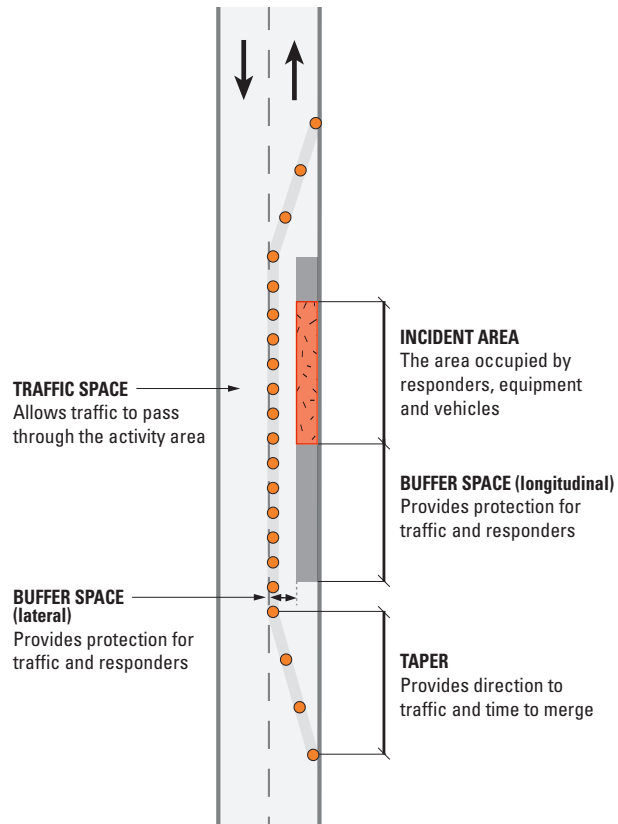

#### Taper

A taper, using traffic cones/flares, should be set up as soon as practicable any time there is a lane closure and/or traffic is moved from one lane to another.

Walking a straight line taper can be both difficult and dangerous, and exposure to traffic flow is almost certain. Therefore, when resources permit:

- A spotter should be present to assist in watching for traffic during taper set up.
- Personnel should place and retrieve cones/flares while facing oncoming traffic.

The speed of the highway should be considered when determining the length of a taper. Typically, a higher highway speed means the need for

a longer taper. However, initial scene set up is dynamic in nature and a balance must be reached between the highway speed and the number of available cones/flares.

For example, if the first responder on scene only has six cones/flares available when responding to an incident on a higher speed highway, they will be only able to set up a short taper; however, **any taper is better than no taper**. A short taper should be extended as soon as resources permit.

#### NOTE

Any taper is better than no taper.

It is recommended that emergency responder vehicles be equipped with, at a minimum, six to eight traffic cones/flares that comply with OTM Book 7.

Key points to remember when setting up a taper:

- A taper should encompass all equipment on the scene.
- Tapers should be set up to accommodate for sight obstacles. The taper should end at the upstream end of the longitudinal buffer space.

- Maximize the space covered with the cones/flare available.
- Block as much of the highway as needed and extend the taper out as far as possible to allow drivers adequate time to merge.

### Buffer Space (Longitudinal)

When setting up cones/flare, a Longitudinal Buffer Area (LBA) that is free of vehicles, equipment, and people, should be provided between the end of the taper and the actual incident area. Cones/flare should be placed along the edge of the LBA, defining a clear boundary between the traffic and the buffer area.

### Incident Area

The incident area is the section of the highway where response activities take place. Cones/flare should be placed along the edge of an incident area, starting at the end of the buffer area to help define a clear boundary between the traffic space and the activity area.

When required, a **lateral buffer space** should also be provided. Lateral buffer space:

- Is a clear area between the incident and the path of travelling vehicles.
- Allows room for responders to work and can encompass partial lanes or an entire lane (i.e., the amount of area necessary to perform duties).

The amount of lateral buffer space is dependent on many conditions including, but not limited to:

- Time of day.
- Weather conditions.
- Highway conditions.

## A.4.2 Conditions that Affect Cone Placement

---

Cone placement should be adjusted (i.e., tapers lengthened, cones enhanced by flare) to account for the following:

### 1. Maximum-Posted Speed

Highway speed affects warning device placement due to:

- The distance travelled while reacting to the perceived hazard. For example, a vehicle that is travelling at 100 km/h is covering about 28 metres (91') per second. Therefore, higher speeds require longer advanced warning/visibility and tapers.
- The distance required to stop the vehicle after vehicle brakes have been applied. Therefore, higher speeds require a longer buffer space and taper.

### 2. Obstruction of the View

Obstacles can keep a driver from seeing the cones/flare, control devices, or hazards.

View obstructions are not the same as reduced visibility. In reduced visibility, the object gradually becomes visible.

Examples of horizontal view obstructions include:

- Embankments.
- Hedges.
- Trees.
- Buildings.
- Vehicles.

Examples of vertical view obstructions include:

- Crests of hills.
- Bridges.
- Overpasses that affect the sight distance or line of sight of drivers.

### 3. Reduced Visibility

Weather and darkness do not obscure a view in the same way as solid objects, but they reduce visibility. They lessen the distance at which you can see things. Some examples include:

- Darkness – lack of lighting or over-driving headlights.
- Weather – fog, smoke, rain, snow, or any combination of these.
- Darkness and weather may combine to further reduce visibility.

The motorist may sometimes drive too fast for conditions present.

### 4. Glare

Glare temporarily blinds the field of vision of a motorist. Examples of glare include:

- Headlight glare - only at night, from oncoming traffic.
- Fixed light glare - back lighting, signs, and stationary vehicles.
- Sun glare - sun glare may make objects invisible to the motorist.

### 5. Other Factors

- Motorist confusion between existing traffic control devices, signals, or pavement markings, and emergency traffic control devices.
- Any change in alignment of a straight and level highway (i.e., elevation, curve, embankment, sudden changes in highway width, on-ramps, off-ramps, or intersections).
- Spacings between cones should provide a visual deterrence from having vehicles enter the closed area. For a reference value of maximum distance between cones, refer to [Table A](#), [Table B](#), or [Table C](#) in [Section 6](#) in OTM Book 7.

## A.5 Positioning of Emergency Response Vehicles

Emergency vehicles may be parked in such a way that they protect incident responders and secure the scene by directing traffic before additional traffic control devices arrive.

### Guidelines for Positioning of Emergency Response Vehicles:

- Emergency vehicles should not unnecessarily impede traffic.
- Emergency vehicles should only block lanes as needed to work safely and efficiently and should return the highway to normal traffic flow as quickly as possible.
- Preferably, all emergency vehicles should be parked on the same side of a highway, in the same direction of the incident.
- The fend-off position is the recommended method for positioning the first emergency vehicle at an incident to provide added protection to the scene from traffic. This position gives approaching motorists the best visibility of the emergency vehicle's side while allowing them to recognize the incident.
- The vehicle is positioned at an angle adequate to protect the incident. This position may also deflect any high-speed impact that would otherwise crash into the scene.
- The vehicle should be positioned to provide both a longitudinal and a lateral buffer space. Subsequent Blocker Trucks or Crash Trucks that arrive on scene should park upstream in accordance with [Section 4](#) in OTM Book 7.
- Vehicles that do not protect the scene or responders should be staged in a safe area. Their location should not create a traffic hazard, obstruction, or impede other emergency vehicles.

**Figure A.2 Longitudinal and Lateral Buffer Space**

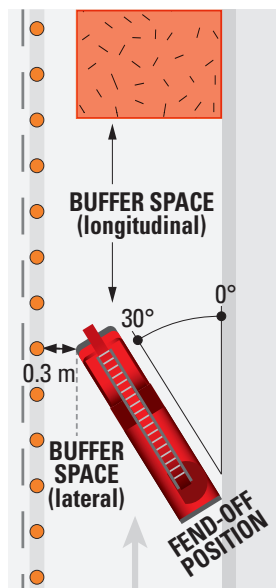

A buffer space established between the incident scene and emergency vehicles is recommended. The suggested distance is 4.0 metres for every 10 km/h of posted highway speed. Reasons for this include:

- If the emergency vehicle is hit from behind, it may not be pushed into the original incident.
- Apparatus remains functional for firefighting operations.
- Scene preservation (crews will not drive inside the collision scene and destroy evidence).
- Cones/flares can be used to close off the buffer space to vehicular traffic by placing them along the lane pavement markings.

### Lateral Buffer Space

- Position the front and/or back bumper of the emergency vehicle at least 0.3 metres from the pavement markings of an open live lane.
- One emergency vehicle in the fend-off position is permitted per lane. The lane adjacent to the incident may be taken to provide a buffer, but an additional emergency vehicle in the fend-off position is required per additional lane.
- This lateral buffer is used to reduce encroachment into the designated traffic lanes.
- Traffic cones/flares should be also placed on the skip line beside the emergency vehicle.

## A.6 Situations that Require Special Attention

### Traffic Control at Rail Crossings

Traffic control at any railway crossing is controlled by rail crossing signs/signals. First responders can neither stop the train nor control their signals.

If an incident affects rail traffic movement or presents a hazard anywhere along the railway right-of-way:

- Contact dispatch or the appropriate railway police authority (i.e., CNR, police).
- Have the trains stopped until the hazard has been removed or stabilized.

### Guidelines for Traffic Control at Rail Crossings:

- Traffic control must be provided to prevent vehicles from stopping on railway tracks.
- Do not stop or park on the railway right-of-way.
- No traffic control devices are to be used on the railway right-of-way.

Each emergency agency should be familiar with contacting the appropriate railway operator within their jurisdiction.

#### NOTE

Each emergency agency should be familiar with contacting the appropriate railway operator within their jurisdiction.

### Traffic Control on High-Speed Highways

High-speed highways present special problems for emergency traffic control. Moving vehicles should always be considered a threat to safety.

When working on high-speed highways:

- Extra care must be taken to ensure visibility and minimize exposure.
- Personnel should not remain in or position themselves beside vehicles that are closing a traffic lane.

- All lane closures should start from the nearest shoulder to the incident site and extend across as many lanes as required, separately closing each lane.
- Where possible, lane closures should be accomplished with vehicles instead of cones or flares.
- Some incident scenes will be located at the end of a curve or near the top of a crest. In these situations, lane closures must be completed well in advance of the view obstruction to provide oncoming motorists with adequate warning.
- On high-speed highways, additional advance warning devices may also be required on the approach to the lane closures.

### **Encroachment into Incident Space during Traffic Control Operations**

Traffic control personnel are trained to operate, whenever possible, off the travelled portion of a highway.

In case of emergencies, traffic control personnel are to:

- Use their planned escape route for oncoming traffic incidents.
- When safe to do so, they are to return to their assigned position and let other emergency responders handle the new emergency as required.

## **A.7** Progression of Traffic Control

---

The following illustrations present the progression of traffic control for various scenarios as a guideline to first and secondary responders.

[Figure A.3 Incident on Shoulder \(Non-freeway\)](#)

[Figure A.4 Incident on Shoulder \(Freeway\)](#)

[Figure A.5 Incident in Live Lane \(Two-Lane Highway\)](#)

[Figure A.6 Incident in Live Lane \(Multi-Lane Non-Freeway\)](#)

[Figure A.7 Incident in Live Lane \(Freeway\)](#)

[Figure A.8 Typical Setup of Incident in Live Lane \(Freeway\)](#)















<b>Legend</b>	
Symbol	Description
	Traffic Control Devices TC-51, TC-52, TC-54 or flares
	Traffic Control Person (TCP)
	Work Vehicle, Sign Truck, Blocker Truck, Crash Truck, or Service Vehicle
 Beacon + 4WF	Vehicle Four-Way Flashers and 360° Beacon (4WF/360° Beacon)
	Incident Area
	TC-12 Arrow Mode
	TC-12 Bar Mode
	Emergency Scene Ahead Sign
 ERV	Emergency Response Vehicle
	EMS Vehicle
	Fire Truck
	Police Vehicle

Figure A.3 Incident on Shoulder (Non-freeway)

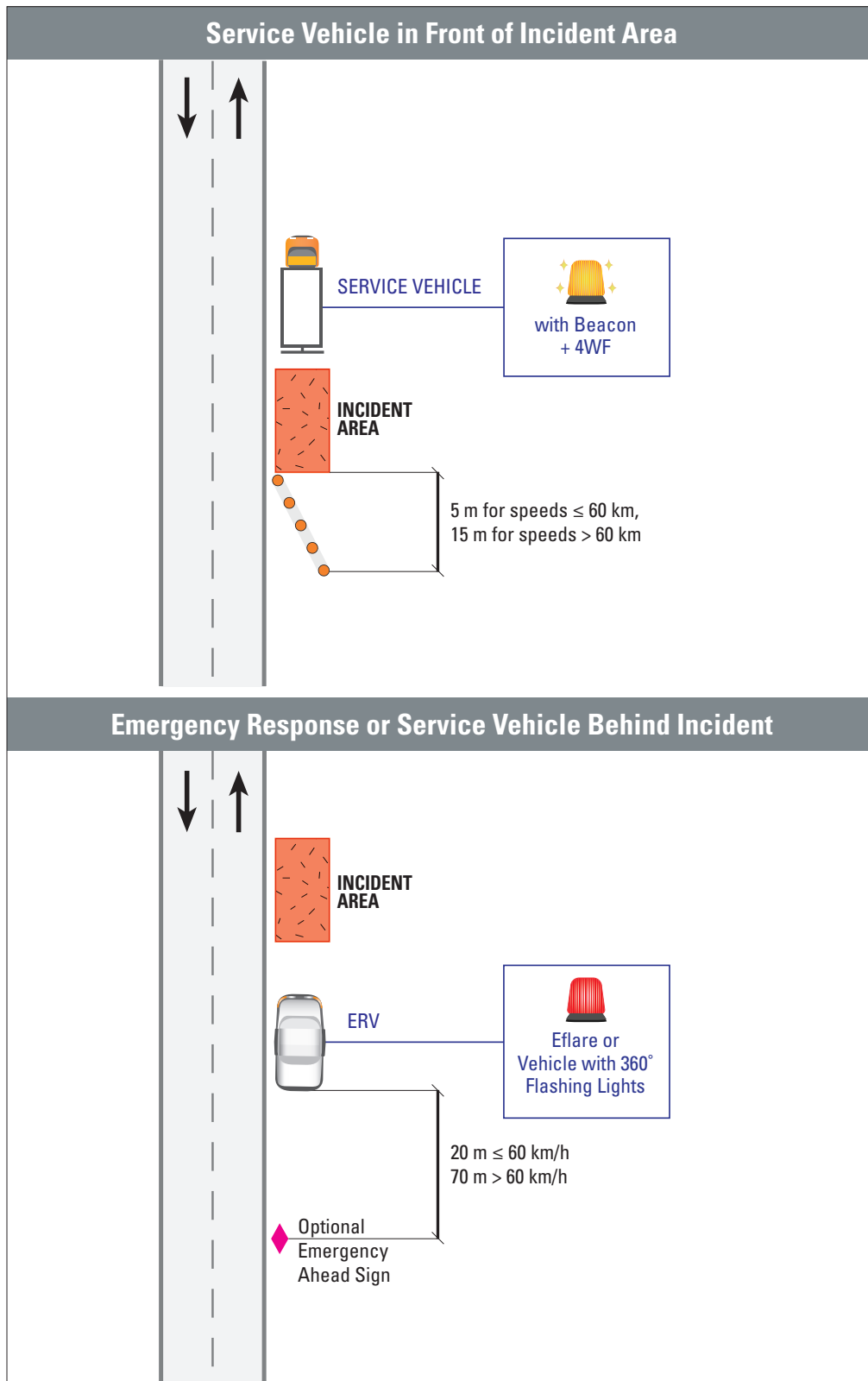
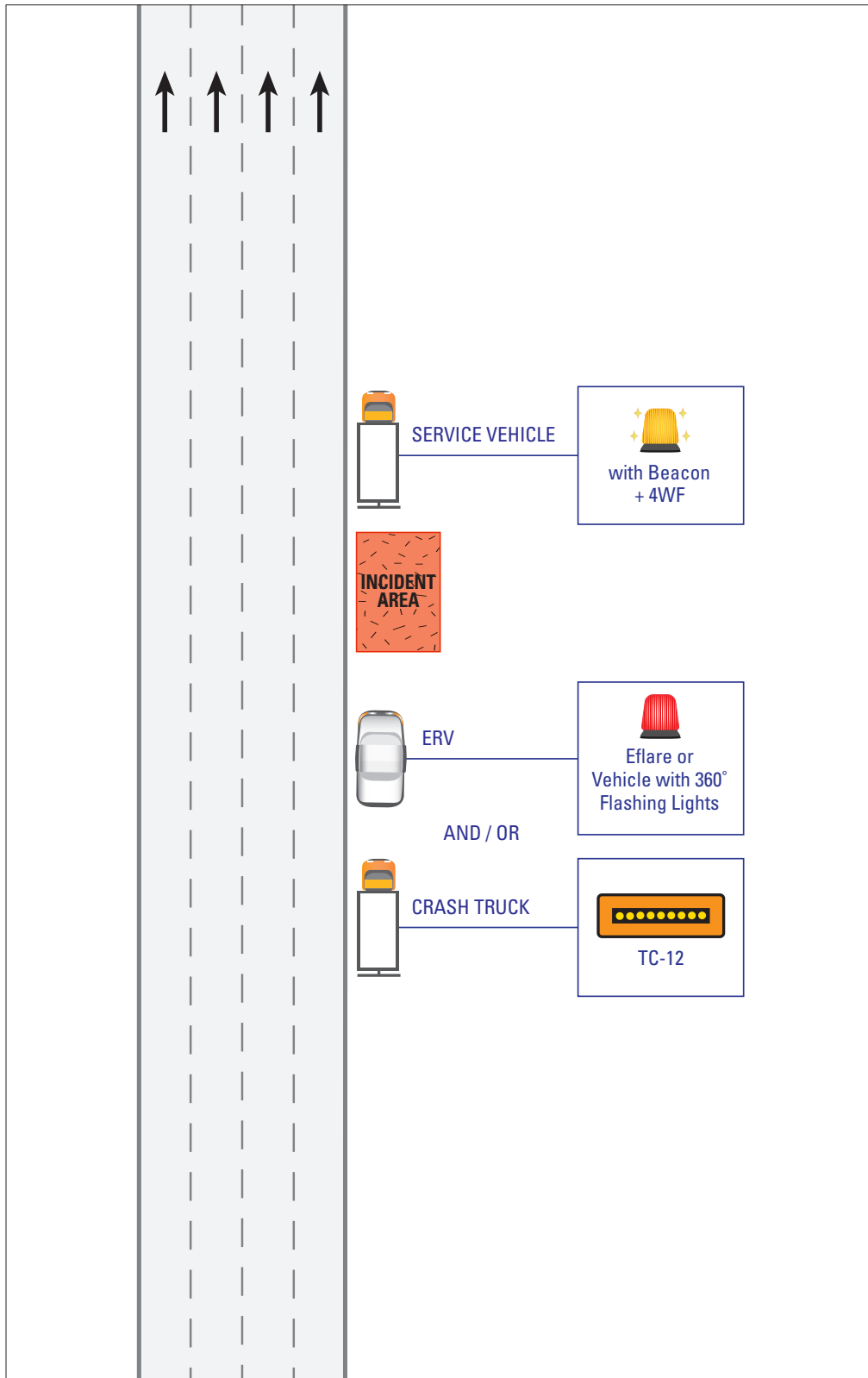

Figure A.4 Incident on Shoulder (Freeway)



**Figure A.5 Incident in Live Lane (Two-Lane Highway)**

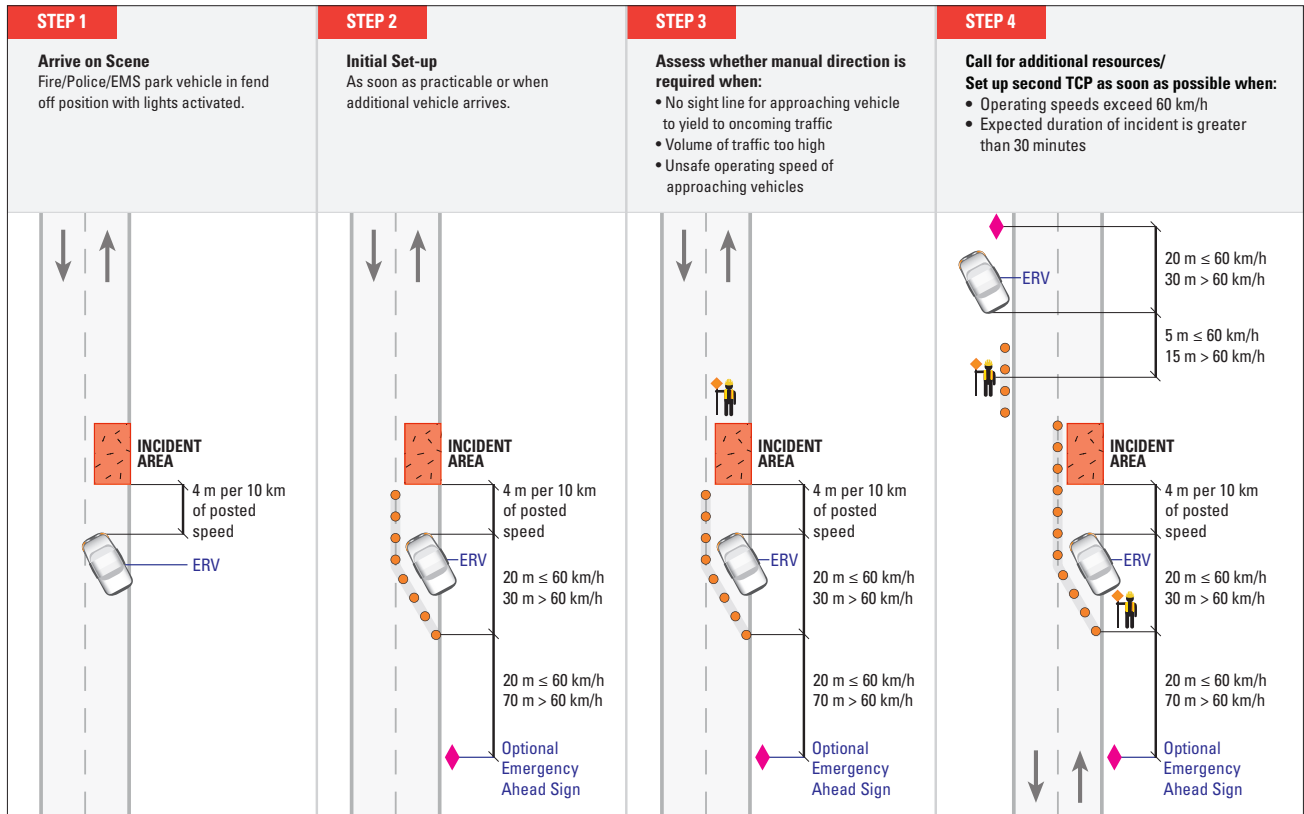
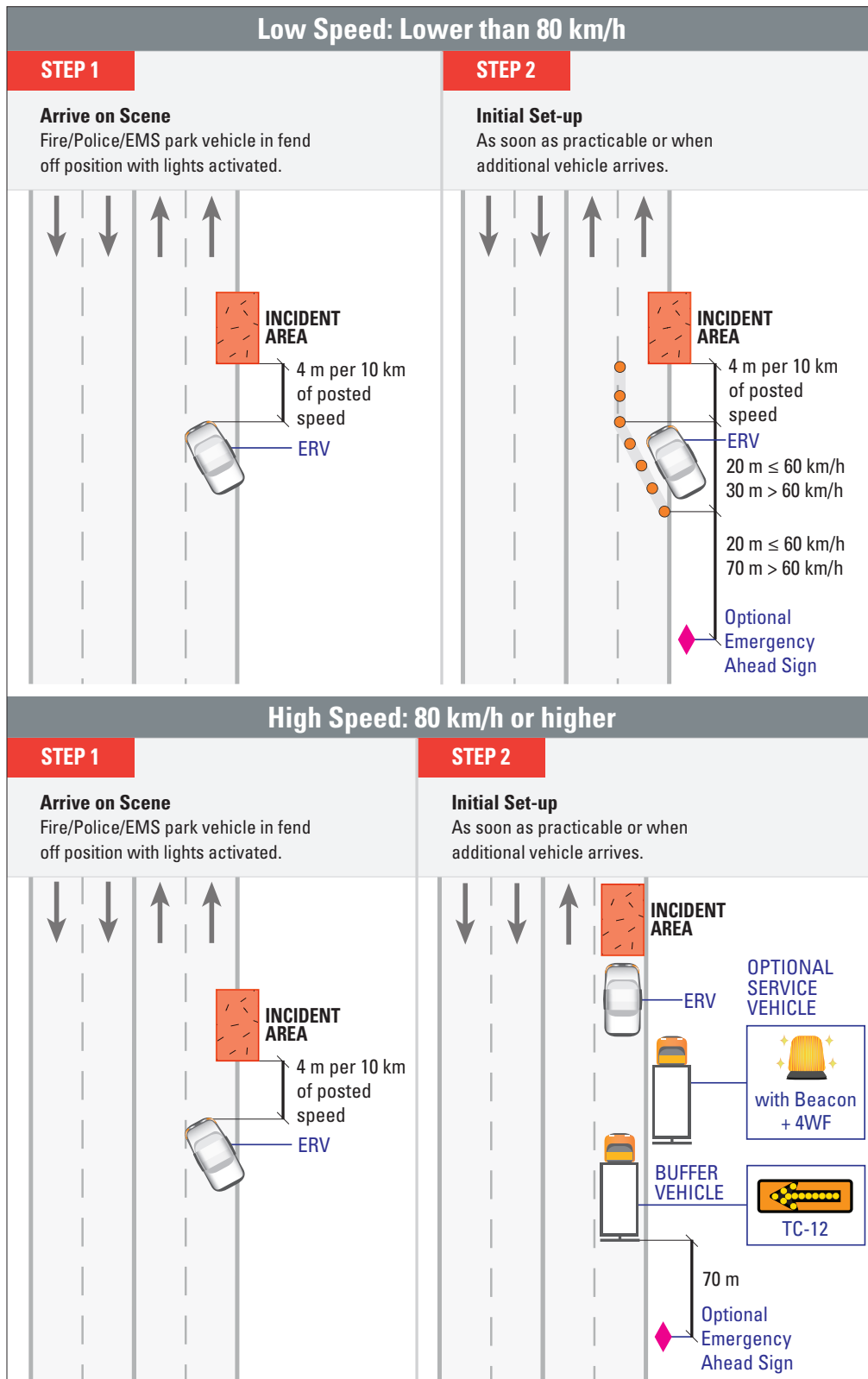

Figure A.6 Incident in Live Lane (Multi-Lane Non-Freeway)



**Figure A.7 Incident in Live Lane (Freeway)**

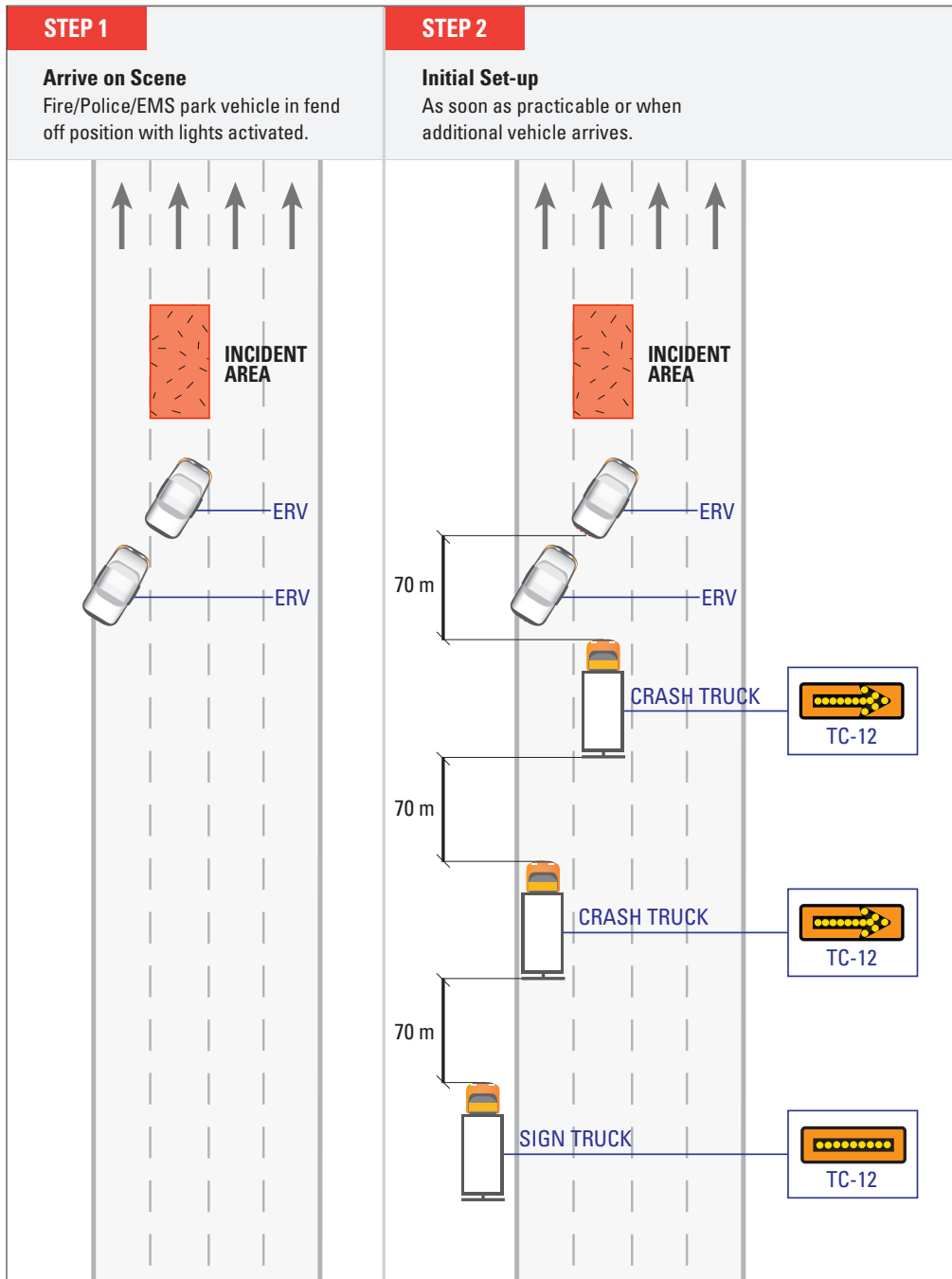
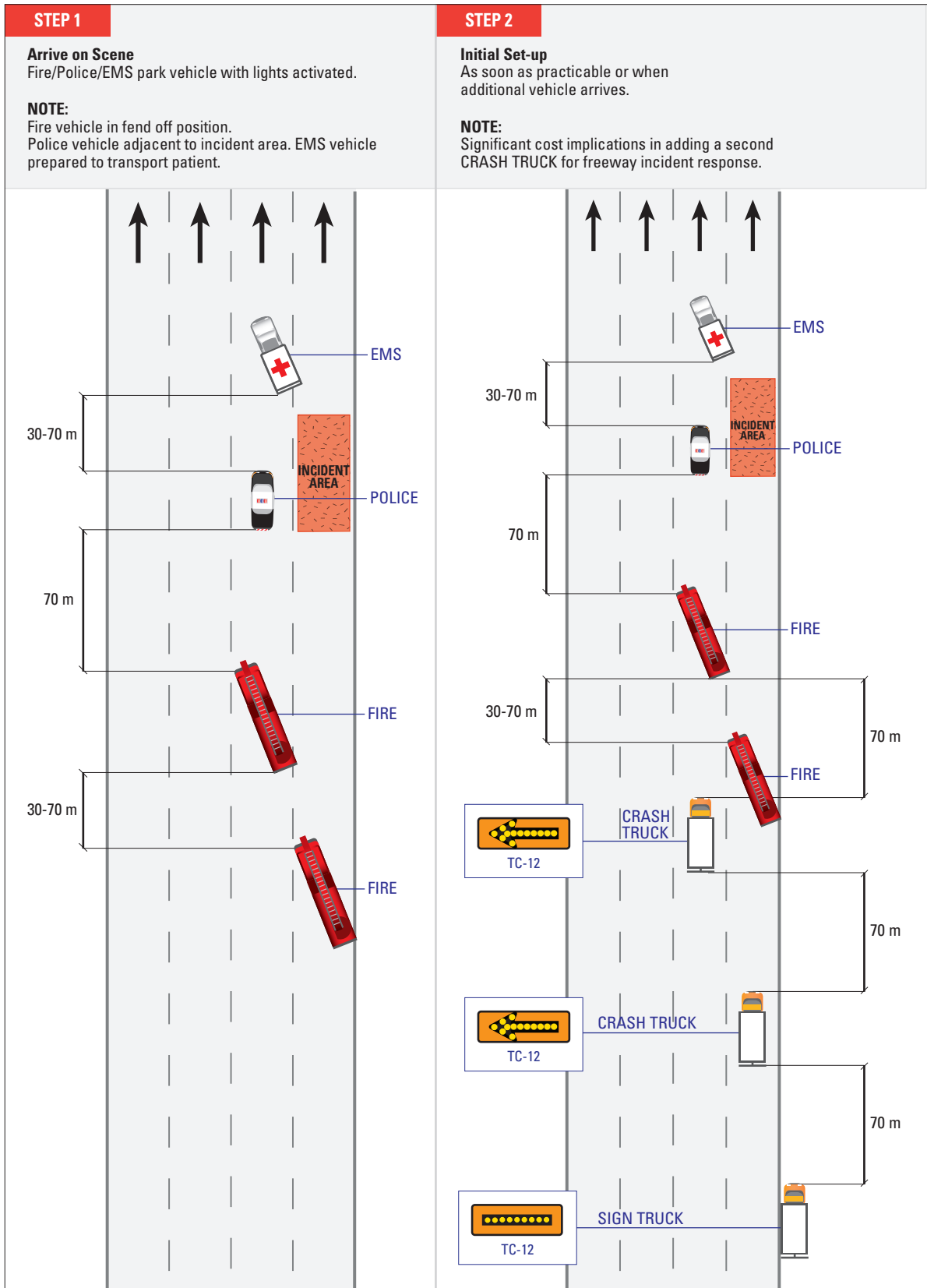

Figure A.8 Typical Setup of Incident in Live Lane (Freeway)



**B****Appendix B: Glossary**

---

**360-Degree Beacon (4WF/360°)**

A 360-degree beacon is a device with an intensely directed light source that continuously shows the light source thru all 360 degrees of the compass. This device must complete a full rotation every 1.5 seconds. Alternatively, rotating LED amber lights can be used in place of 4WF plus 360-degree beacon. See Rotating LED Amber Lights.

**A****AADT**

Annual Average Daily Traffic.

**Acceleration Lane**

A speed change lane for the purpose of:

1. Enabling a vehicle that is entering a highway to increase its speed to a rate at which it can more safely merge with through traffic.
2. Providing the necessary merging distance.
3. Giving necessary time to the main highway traffic to make appropriate adjustments.

**Advance Notification Signing (ANS)**

Signing installed on an affected route prior to the establishment of a work zone. Used to forewarn regular users of a route that work is planned in the near future.

**Advance Warning Area**

The first component of a work zone, upstream of the approach area, used to alert drivers to road work ahead.

**Advance Warning Signing (AWS)**

Signing installed on an affected route to inform highway users of the scope, extent, and duration of a planned work activity. Work may be continuous or reoccurring.

**Advisory Speed**

The speed, determined to the nearest 5 km/h, at which traffic may safely negotiate a potential hazard under favourable driving conditions. Used whenever an unexpected change in geometrics is caused by the work activity.

**AFAD**

See Automated Flagger Assistance Device.



**All-Red Interval Signal (Traffic Signal)**

The time in seconds of a red indication for all intersection traffic. It is used following an amber clearance interval to permit vehicles or pedestrians to clear the intersection before conflicting traffic receives a green indication. In temporary conditions, the all-red interval is used to clear a one-lane section through a work site before opposing traffic receives a green indication.

**Alternate Route Signing (ARS)**

Signing installed on an affected route describing an alternative route to either reach a destination or to bypass congestion. The alternative route itself receives no temporary signing.

**Amber Clearance Interval (Traffic Signal)**

The clearance interval in which the signal indication for that phase is amber. A clearance interval to warn approaching traffic to clear the intersection before conflicting traffic receives a green indication.

**Annual Average Daily Traffic (AADT)**

The total yearly traffic volume on a given highway divided by the number of days in the year.

**ANS**

See Advance Notification Signing.

**AODA**

Accessibility for Ontarians with Disabilities Act.

**Approach Area**

The second component of a work zone used to inform highway users of actions that are required or prohibited such as lane changes, speed reductions, passing restrictions, etc. Highway users require this information at a sufficient distance in advance, to be able to adjust to the altered situation before reaching it. Approach area devices may vary from a single sign or flashing lights, to a series of signs in advance of the transition area.

**ARS**

See Alternate Route Signing.

**ASTM**

American Society for Testing and Materials.

**At-grade Intersection**

An intersection of two highways where there is no vertical separation between the two highways at their point of intersection.

**ATSSA**

American Traffic Safety Services Association.

### **Automated Flagger Assistance Device (AFAD)**

A self-contained, portable traffic control system that is operated remotely by a Traffic Control Person to control traffic movement and features a circular red lens, a circular yellow lens, and a gate arm.

### **Average Daily Traffic (ADT)**

The total volume during a given time period in whole days greater than one day and less than one year, divided by the number of days in that time period.

### **AWS**

See Advance Warning Signing.

## **B**

### **Ballast Filled Barrier**

Longitudinal barrier of segmented polyethylene plastic shells with a steel framework, designed for use with ballast of water or sand. Ballast filled barriers should only be used when approved by the road authority.

### **Barricade**

ATC-53 channelization and delineation device, typically with one or two rails, which provides a visual indicator of a hazardous location or the desired path that a motorist should take but is not intended to contain or redirect a vehicle. A barricade is intended to provide separation or inform of closure or provide direction to pedestrians. A barricade is not the primary means of providing direction to motorists, but supplements other traffic control devices that provide delineation.

### **Barrier**

A device which protects work zones and drivers by providing a physical limitation, through which a vehicle would not normally pass, and is intended to contain or redirect an errant vehicle of a particular size range, at a given speed and angle of impact.

### **Blocker Truck (BT)**

A Buffer Vehicle (BV) that is not equipped with a truck-mounted attenuator (TMA).

### **Brightness**

A term that refers to human perception of luminance. Whereas luminance is a photometrically measured quantity, brightness describes how intense a light source or lighted surface appears to the human eye.

### **Broken Line**

A pavement marking that consists of a cycle of marking segments and gaps. Broken lines are permissive and inform drivers that they are permitted to cross a broken line (two-lane, two-way highways or multi-lane highways) or that there is a change in the use of a particular lane (continuity lines).

**Buffer Vehicle (BV)**

A truck placed upstream of a work area to provide a protective shield for workers against an out of control vehicle approaching a work area. The BV should be unoccupied for stationary operations and may be equipped with a Truck or Trailer Mounted Attenuator (TMA). A BV without a TMA is defined as a Blocker Truck (BT). A BV with a TMA is defined as a Crash Truck (CT). A CT is preferred over a BT as the TMA reduces the risk of injury to the occupants of the incoming vehicle and to the CT driver. A BV requires a mounted TC-12 FLASHING ARROW BOARD SIGN and four-way flashers.

**CTs used on MTO contracts must have:**

- Minimum mass of 6,800 kg (15,000 pounds), excluding attachments or ballast.
- Maximum mass of 12,000 kg (26,400 pounds), including any ballast, flashing arrow boards, or TMA.

**Bull Nose**

The area or point of divergence between two diverging highways, such as freeway mainline lanes and an exit ramp.

**BT**

See Blocker Truck.

**BV**

See Buffer Vehicle.

**C****Capacity**

The maximum number of vehicles which can pass over a given section of lane or a highway in one direction, or both directions for a two- or three-lane highway, during a given time period (usually one hour) under prevailing highway and traffic conditions.

**Centreline**

See Directional Dividing Line.

**CGSB**

Canadian General Standards Board.

**Changeable Message Sign**

A dynamic message sign which may display a limited number of fixed messages, any one of which may be displayed at any given time or with no message at all. It is an electrical, electro-optical, electromechanical, or mechanical sign which permits the sign message to be either locally or remotely changed. See also Dynamic Message Sign and Variable Message Sign.

**Channelization**

The separation or regulation of traffic movements into definite paths of travel by use of pavement markings, raised islands, channelizing devices, or other suitable means to facilitate the safe and orderly movement of both vehicular and pedestrian traffic.

**Channelizing Devices**

Cones, construction markers, flexible drums (barrels), pavement markings, and any temporary barriers used to alert drivers to and direct traffic past hazards created by construction or maintenance activities.

**Chevron Alignment Sign**

A delineation sign (TC-18) used to delineate sharp highway alignment changes. See also OTM Books 6 and 11.

**Closed Lane**

A traffic lane on a highway that has been closed off to traffic by channelizing devices, signs, temporary construction barrier system (TCBS), and/or TC-12 flashing arrow board signs.

**Collision**

An incident that results in property damage, personal injury or death, and involves the loss of control and/or the striking of one or more vehicles with another vehicle, person, animal, or inanimate object.

**Comprehension**

The ability of drivers to understand the meaning of a sign message, including any symbols or abbreviations.

**Cone of Vision**

The small three-dimensional angle of vision, measured at about the axis of the eye's pupil, and from the surface of the eye, within which maximum visual acuity is achieved.

**Conspicuity**

The ability of a traffic control device to attract or command attention, given the visual setting in which it is placed.

**Construction**

All work zone activities, including pre-engineering activities, related to the building, infrastructure repair, or rehabilitation of highways or utilities that are along or crossing highways.

**Construction and Maintenance Signs**

A group of regulatory and warning signs used for the protection of public traffic and workers in the vicinity of a work area located on or near a highway.

**Construction Marker**

A TC-52 channelization and delineation device.

**Construction Zone**

A construction zone encompasses the full length of a project. Within a construction zone there may be one or more work zones. The road authority may legally establish speed fines which are doubled when workers are present. A construction zone must be designated and signed in order to have enforceable maximum speed limits.

**Continuity Line**

A lane line of reduced spacing and increased width, designed to alert highway users to an impending change in lane function.

**Continuous Wide Median**

On a divided highway, a median that has a continuous width of 10 metres or more. See also Divided Highway.

**Contrast**

Contrast refers to the differences in colour or brightness which allow a target, such as a sign message or symbol, to be seen against a sign background.

$$\text{Contrast} = (RL - RB)/RB$$

$$\text{Contrast Ratio} = RL/RB$$

where: RL is Reflectance of Legend; and RB is Reflectance of Background. For light-emitting dynamic message signs, the same relationships apply, except that reflectance is replaced by emitted light intensity for both legend and background.

**Controlled Access Rights-of-Way**

Control of access is the condition where the right of access to or from a highway, by owners or occupants of abutting land or other persons, is fully or partially controlled by the road authority.

**Crash**

See Collision.

**Crash Cushion**

A traffic barrier used to safely shield fixed objects or other hazards from approximately head-on impacts by errant vehicles, which consists of energy-absorbing elements that are progressively deformed on impact.

**Crash Truck (CT)**

A Buffer Vehicle (BV) equipped with a truck-mounted attenuator (TMA) that meets the requirements of the National Cooperative Highway Research Program Report (NCHRP) 350.

**CSA**

Canadian Standards Association.

**CT**

See Crash Truck.

**Curve**

A horizontal or vertical deviation in the highway. A horizontal curve appears as a bend in the highway, which requires drivers to turn their steering wheel. A vertical curve appears as either a “crest” or “sag” to provide for a change in gradient on the profile of the highway.

**Curve Sign**

A warning sign used to inform drivers of an upcoming change in highway alignment. In some cases, a reduction in speed is recommended.

**Cyclist**

A person who is riding a bicycle.

**D****Deceleration Lane**

A speed change lane for the purpose of enabling a vehicle to make an exit from a highway and slow to a safe speed on the exit after it has left the main stream of traffic.

**Delineation**

One or a combination of several types of devices (excluding guide signs) that regulate, warn, or provide tracking information and guidance to drivers.

**Delineation Treatment**

Refers to the higher-level decision process of designing delineation to be installed. Issues such as use of raised pavement markers and post markers are part of delineation treatment.

**Delineators**

Small, retroreflective devices erected in a series adjacent to the edge of the travelled portion of a highway for the purpose of providing positive driver guidance.

**Design Incoming Vehicle (DIV)**

The selected vehicle or vehicles with the size and mass that correspond to a certain proportion of the vehicle population, or a defined level of protection, used in the determination of BV mass and roll-ahead distances for the design of construction and maintenance work zones.

### **Designated Sources for Materials (DSM)**

The MTO DSM is the official list of pre-qualified products and vendors for use on provincial highway construction and maintenance contracts. The MTO does not warrant that the sources listed on their DSM will produce an acceptable or sufficient product for any contract. The MTO DSM listing only indicates that the listed manufacturer/distributor is capable of producing a product that meets MTO requirements or has demonstrated the ability to meet them in the past.

### **Design Speed**

A speed selected for the purposes of the design and correlation of those features of a highway, such as curvature, superelevation, and sight distance, upon which the safe operation of vehicles is dependent.

### **Detector**

A device that indicates the presence or passage of vehicles, including sensor devices, lead-in cables and detector sensor (amplifier) units.

### **Detour**

Occurs when traffic cannot be adequately accommodated within an existing highway and must be diverted from its normal path. Guidance of traffic through detours requires signage that is continuous and complete to guide drivers back to the normal route.

### **Detour Marker**

A sign used to identify a route detour for detour route continuity to assist driver navigation.

### **Device**

See Traffic Control Device.

### **Directional Dividing Line**

A yellow pavement marking that indicates the division of the highway between traffic travelling in opposite directions.

### **Directional Guide Sign**

A broad class of signs that provide route-finding or operational guidance to highway users, including directions to specific destinations.

### **Divided Highway**

A multi-lane highway that physically divides the two-way traffic with dirt, grass, or raised medians. See also Continuous Wide Median.

### **Downstream**

The direction that traffic is going to.

**Driver**

A person who operates a vehicle on a highway.

**Driver Response**

The action taken by a driver as a result of reading a traffic sign or encountering another traffic control device.

**DRS**

Detour Route Signing.

**DSM**

See Designated Sources for Materials.

**DTS**

Detour Trailblazer Signing.

**Duration**

1. The length of time for which a given state, condition or phase exists.
2. In temporary conditions, the length of time for specific construction, maintenance or utility work activities to take place, and for which specific requirements and layouts apply. See Mobile Operations, Intermittent Duration, Very Short Duration, Short Duration, and Long Duration.

**Dynamic Message Sign**

A sign that has the capability of displaying different messages to suit changing conditions on a highway. A dynamic message sign may be a changeable message sign (limited function) or a variable message sign (full function).

**E****Edge Line**

A painted line that marks the edge of a highway.

**Eighty-fifth (85th) Percentile Speed**

The speed at, or below which, 85% of motorists are travelling.

**Emergency**

With regard to road works, an emergency is an unforeseen, unplanned combination of circumstances or the resulting situation that calls for immediate action in order to prevent or reduce damage or hazard to road users, workers, or infrastructure. In an emergency, short duration traffic control provisions should be implemented to the greatest extent practicable, including adequate reflectorization if at night, in order to avoid the creation of additional hazard.



**EMS**

Emergency Medical Services.

**Energy Attenuator**

Energy attenuators on barrier ends are needed to reduce the severity of impacts. Energy attenuators shall be according to OPS or other standard as specified by the road authority.

**Engineering Grade Material**

A retroreflective sign sheeting material that meets ASTM Specification D-4956-19 for Type I material or CGSB Specification 62-GP-S11M for Reflectivity Level II material.

**Expectancy**

Used in traffic engineering to describe a driver's anticipation of upcoming road design and traffic control conditions. Driver expectancy is usually affected by previous experience and the consistency and continuity of traffic control devices encountered. Violation of driver expectancy should be avoided whenever possible.

**Expressway**

A divided, multi-lane arterial highway for through traffic with full or partial control of access and generally with grade separations at major intersections. Some intersections may be at-grade.

**F****f**

Coefficient of friction; sometimes CoF is used.

**Field Edition**

The portable abbreviated version of Ontario Traffic Manual (OTM) Book 7

**Flexible Drum (Barrel)**

ATC-54 channelization and delineation device.

**Fluorescence**

The emission of light produced by certain substances when excited by an ultraviolet (UV) energy source. This emission ceases when the UV source is removed.

**Fluorescent Orange and Yellow-Green**

Fluorescent sign sheeting colours designed for high conspicuity in daytime. Fluorescent sign sheeting may be non-reflective (daytime use only) or reflective (daytime and night-time use).

**Freeway**

For the purpose of the guidelines of OTM Book 7 a freeway is defined as a multi-lane divided highway

with a continuous dividing median (demarcated by more than pavement markings), full control of access and interchanges in place of at-grade intersections, and a normal posted regulatory speed (NPRS) of 90 km/h or greater. This term includes all 400 series divided highways and toll highways built to a freeway configuration, and all freeway speed transition zones where the speed limit has been reduced approaching the end of the freeway and other areas where speed reductions are in place due to geometrics such as curves or freeway to freeway ramps.

## **G**

### **Geometry**

In terms of highway design, geometry refers to the physical characteristics and dimensions of highway parts.

### **Glare Screen**

Glare screens are mounted on the top of barriers to minimize distraction to highway users. Their ability to discourage driver distraction and reduce headlight glare from opposing traffic may improve safety and traffic flow.

### **Gore**

The area between and immediately adjacent to two merging or diverging highways; the area may be painted or unpainted.

### **Grade Crossing**

A railroad that crosses a highway at the same elevation (no vertical separation).

### **Grade Separation**

The vertical separation of two or more intersecting highways or a highway and another transportation mode, e.g., railroad, thus permitting traffic on all highways to cross traffic on all other highways without interference.

### **Gross Vehicle Weight**

The total weight in kilograms transmitted to the highway by a vehicle or combination of vehicle and load. This is not the same as the registered gross vehicle weight, which is a licensed measure.

### **Guide Rail**

A fence or barrier to guide and help restrain vehicles from leaving a highway.

### **Guide Sign**

Traffic sign used to guide traffic around or through work areas, to provide information to highway users related to detours, directions, or types of construction.

**Guideline**

A recommended practice, method, or value for a specific design feature or operating practice.

**H****HAR**

See Highway Advisory Radio.

**Hazard Marker**

See Object Marker.

**Headway**

The spatial distance or time interval between the front ends of vehicles that are moving along the same lane or track in the same direction.

**High Intensity Material**

A retroreflective sign sheeting material that meets ASTM Specification D-4956-19 for Type III or IV or CGSB Specification 62-GP-11M for Reflectivity Level I material.

**Highway**

A general term that denotes a public way for the purposes of vehicular and pedestrian travel, including the area within a right of way. This includes King's Highways, regional and county roads, rural roads, municipal roads, and streets.

**Highway Advisory Radio (HAR)**

Used to provide travel advisory information to motorists as they are travelling in their vehicles. Where used to provide construction/maintenance related information, it is typically necessary to cover only a relatively limited geographical area.

**Highway Delineator**

One of a series of short posts with reflective heads or chevrons, used to indicate horizontal alignment.

**HTA**

Highway Traffic Act (Ontario).

**HOV Lane**

High Occupancy Vehicle Lane.

**Human Factors**

The consideration of human physical, perceptual, and mental limitations in engineering design, so as to optimize the relationship between people and things. The objective is to reduce errors and increase user comfort.

**HVSA**

High-Visibility Safety Apparel.

**I****IARS**

Intercept Alternate Route Signing.

**ID**

See Intermittent Duration (ID) Work.

**IDRS**

Intercept Detour Route Signing.

**IMP**

See Incident Management Plan.

**Incident Management Plan (IMP)**

Plan that outlines priorities and procedures for detecting and rapidly responding to unplanned events to minimize impact on the safety of workers and the public, mobility in order to restore traffic flow. Following an incident, it is critical to document the events that initiated the incident so the TMP can be re-evaluated to determine if any changes are necessary.

**Information Load**

The amount of information presented to a driver by a sign or other traffic control device(s), which is a factor in determining the amount of time that drivers require to read, comprehend, and act on a message.

**Installation**

The process or act of placing, erecting, and/or connecting a traffic control device or system into its functional position and state of operational readiness.

**Interchange**

A system of interconnecting highways in conjunction with one or more grade separations, providing for the interchange of traffic between two or more highways on different levels.

**Interdictory Symbol**

An annular (circular) red band with a diagonal red stroke at 45 degrees, or as close to 45 degrees as practicable, signifying that whatever is depicted within the symbol is prohibited.

**Intermittent**

Not continuous. As used for traffic control devices, usually means regularly spaced either in time or space. Otherwise, may mean regularly or irregularly timed or spaced.

**Intermittent Duration (ID) Work.**

ID work occupies a fixed location for 15 minutes or less, including the time it takes to set up and remove traffic control devices. For example, pothole patching, surveying, dead animal removal, minor debris pickup.

**Internal Traffic Control Plan (ITCP)**

Plan that coordinates and assigns the flow of work vehicles, work equipment, and workers within the work zone to ensure worker safety and should include elements such as highway user paths, work vehicle and equipment paths, ingress and egress points, and storage and staging areas.

**Intersection**

The area embraced by the prolongation of lateral curb lines, or if none, the rights of way of two or more highways that join one another at an angle, whether or not one highway crosses the other.

**Intersection Approach**

The part of an intersection leg used by traffic that is approaching an intersection.

**Intersection Channelization**

Raised or painted islands at an intersection that prevent specific movement(s) from being made or provide better definition of large uncontrolled areas of pavement.

**Intersection Leg**

The part of any one of the highways that radiate from the intersection which is close to the intersection but outside the area of the intersection proper.

**ITCP**

See Internal Traffic Control Plan.

**ITE**

Institute of Transportation Engineers.

**J****Jurisdiction**

A legal or other authority with responsibility and control for specific actions within a defined area.

**K****Kilometre (km)**

A measure of distance equal to 1000 m (0.622 miles).

**King's Highway**

A highway, including secondary and tertiary roads designated under the Public Transportation and Highway Improvement Act.

**km**

Abbreviation for kilometre.

**L****Lane**

A defined width of highway intended to accommodate a single line of moving vehicles.

**Lane Closure/Lane Occupied**

Where travelled lane(s) are closed off and traffic is redirected and are used when highway operations result in lane widths of less than 3.0 metres (3.5 metres for freeways) and/or operations occupy a travelled lane.

**Lane Encroachment**

Where workers, vehicles, or equipment are partially within the travelled lane, but there is at least 3.0 metres (3.5 metres for freeways) in width of useable lane for traffic. Except where required for some maintenance mobile operations, lane encroachment is not recommended on freeways.

**Lane Line**

A pavement marking, other than a directional dividing line, which separates two traffic lanes assigned to traffic which is moving in the same direction.

**Large Arrow Sign**

A warning sign intended to inform drivers of a sharp change in highway alignment or the need for a lane change (see Sign Wa-108 in OTM Book 6, and Signs TC-7 and TC-12 in OTM Book 7).

**Lateral Intrusion**

A lateral intrusion occurs when a vehicle, in a live lane adjacent to the work area, laterally intrudes into the gap in the closed lane between the BV and the work area.

**Lateral Intrusion Deterrence Gap (LIDG)**

The gap between a BV and the work area to discourage lateral vehicle intrusions into a closed lane upstream of a stationary work area, or the gap between a BV and work vehicle (or between two BV) to discourage lateral vehicle intrusions into a lane where mobile work operations are taking place.

**LBA**

See Longitudinal Buffer Area.

**LD**

See Long Duration work.

**LED**

Light Emitting Diode.

**Left-turn Lane**

A lane reserved for left-turning vehicles and designated so by pavement markings and/or lane-use signs.

**Legal Authority**

The authority provided, by legislation and regulation, to a jurisdiction or enforcement body for the actions that it takes.

**Legibility Distance**

The distance at which a sign can be read by a given driver under prevailing conditions.

**Legibility Distance, Required**

The distance at which a sign must be legible, based on the travel speed and the sum of reading, perception-reaction, and manoeuvre times.

**Level of Service (LOS)**

A term which, broadly interpreted, denotes any one of an infinite number of differing combinations of operating conditions that may occur on a given lane or highway when it is accommodating various traffic volumes. Level of service (LOS) is a qualitative measure of the effect of a number of factors, which include speed and travel time, traffic interruptions, freedom to maneuver, safety, driving comfort and convenience, and operating costs. In practice, selected specific levels are defined in terms of particular limiting values of certain factors, as in Levels A (free-flow) to F (stop and go) in the Highway Capacity Manual.

**LIDG**

See Lateral Intrusion Deterrence Gap.

**Live Lane**

A highway lane open to traffic. It includes a traffic lane where vehicles, although they may be present, are being diverted away from a stationary or mobile work activity by work vehicles or BVs equipped with traffic control devices, such as a TC-12.

**Local Road**

A street or road primarily for access to residence, business, or other abutting property.

### Long Duration (LD) Work

Stationary maintenance, construction, or utility activities which require a separate work space for longer than 24 hours. See also Short Duration (SD), Very Short Duration (VSD), and Intermittent Duration (ID) work.

### Longitudinal Buffer Area (LBA)

LBA provides protection for traffic and workers, by providing an opportunity for highway users to brake to a halt between the end of the transition area and the work area or Buffer Vehicle (BV). LBA is the fourth component of a work zone. Traffic control devices, work material, vehicles, and equipment must not be stored or parked in an LBA. When an LBA is used with a BV, the appropriate distance to use in front (downstream) of the BV is called the Lateral Intrusion Deterrence Gap (LIDG). The LIDG is used in combination with the taper, LBA, and BV.

### Longitudinal Intrusion

A longitudinal intrusion occurs when a vehicle enters a closed lane upstream of a stationary work area through the taper. The length of the lane closure taper plus the LBA upstream of the BV should provide the driver with sufficient braking distance.

### LOS

See Level of Service.

### Low Volume/High Volume Highway

For temporary conditions, low volume highways are defined as those with a combined traffic volume in both directions of less than 3000 vehicles per day. High volume highways include any section of highway within the limits of the designated construction zone not matching the criteria of a freeway. High volume and/or high-speed non-freeways may be designated by road authorities as freeways for the purpose of traffic control.

### Luminance

The luminous flux in a light ray, which emanates from a surface or falling onto a surface, in a given direction, per unit of projected area of the surface as viewed from that direction, per unit of solid angle (reflective light).

## M

### m

Abbreviation for metre.

### Maintenance

The upkeep of highways, traffic control devices, other transportation facilities, property, and/or equipment.



**Major Road**

The principal route of two roads at an intersection. Also called main road.

**Maneuver Time**

The time to complete any required maneuver before reaching a sign, other traffic control device, or decision point.

**Marker**

See Construction Marker, Detour Marker, Object Marker.

**Marking (Pavement)**

See Pavement Marking.

**Maximum Speed**

The maximum speed that drivers are permitted to travel. The maximum speed is imposed by the Highway Traffic Act (HTA), or municipal by-laws. See also Normal Posted Regulatory Speed.

**May**

Indicates a permissive condition. No requirement for design of application is intended. However, mandatory requirements apply to some specific options if and when they are selected.

**Measure**

A physical device, traffic control device, regulation, or other action which affects the movement of motor vehicles, bicycles, and/or pedestrians.

**Median**

The portion of a divided highway that separates the travelled ways for traffic in opposite directions.

**Median Barrier**

A raised island, wall, or structure located on the centreline of a highway through an intersection or along a highway, which prevents left turns or straight through movements from being made to and from a side street or private/commercial driveway.

**Median Island**

A zone or physical island constructed in the centre of a highway to separate opposing directions of traffic.

**Median Strip**

An expanse of hard surface material that separates opposing lanes on a highway. The hard surface is flush or nearly flush with the adjacent lanes.

**Merging**

The convergence of separate streams of traffic into a single stream.

**Milling**

The grinding off and removal of old asphalt for the purposes of recycling and resurfacing. Milling may produce undesirable longitudinal grooves which affect the behaviour of some vehicles.

**Minimum Guideline**

Where so described, the guideline depicted in the layouts for temporary conditions represents the minimum requirements that must be achieved.

**Ministry of Transportation Ontario (MTO)**

The MTO, through the Highway Traffic Act (HTA), Public Transportation and Highway Improvement Act, and various related statutes, has the legal authority and responsibility to regulate and control traffic on a highway and regulate and control motor vehicles that operate in the province.

**Minor Road**

The lesser of two roads at an intersection.

**MLTSD**

Ministry of Labour, Training, and Skills Development (Ontario). Previously MOL (Ministry of Labour).

**Mobile Barrier**

Mobile Barrier systems consist of a modular unit on wheels pulled by a standard truck tractor with reversible axles which allow the unit to be reconfigured for either right or left applications. The mobile unit alleviates the need for highway crews to use a TCBS, which reduces the exposure of workers to traffic and the overall duration of work.

**Mobile Operations**

Mobile Operations involve work that is done while continuously moving, usually at low speeds (typically 5 to 30 km/h). Mobile Operations may have periodic brief stops related to the mobile activity which do not exceed a few minutes in duration. During a brief stop, no planned work takes place outside of the work vehicle.

**MOL**

Previously Ontario Ministry of Labour. See MLTSD.

**Motor Vehicle**

Includes an automobile, motorcycle, motor-assisted bicycle (moped), and any other vehicle propelled or driven other than with muscular power, but does not include a streetcar, or other vehicles designed to operate on rails, or a motorized snow vehicle, traction engine, farm tractor, and implements of husbandry or road-building machine.

**Motorist**

See Driver.

**Movable Barrier**

Sections of linked barriers that can be mechanically shifted laterally through the use of a special purpose vehicle. Typically used to provide a reversible lane, and when the risk associated with frequent lane closures required to accommodate construction staging warrants the expense of a moveable barrier. The application of moveable barriers must be approved by the road authority.

**MTO**

See Ministry of Transportation Ontario.

**Multi-lane Highway**

Highways with more than one lane dedicated to each direction in two-way traffic.

**Municipalities**

Have the legal authority and responsibility, through the Municipal Act and various regional municipality acts, to regulate and control traffic on their highways. The authority and responsibility also apply to construction and maintenance activities on highways.

**Must**

Indicates a mandatory condition. Where certain requirements in the design or application of the device are described with the “must” stipulation, it is mandatory that these requirements be met when an installation is made.

**MUTCD**

The Manual of Uniform Traffic Control Devices for Ontario, 1995, superseded over time by the Ontario Traffic Manual.

**MUTCDC**

The Manual of Uniform Traffic Control Devices for Canada, latest edition.

**MUTCD-US**

The U.S. Manual of Uniform Traffic Control Devices, latest edition.

**N****Narrow Lanes**

Lanes in a work zone which are narrower than usual, as required by construction, maintenance, utility, or other operations.

**NCHRP**

National Cooperative Highway Research Program (U.S.).

## Night-time

The hours of darkness, taken as the time period from one-half hour before sunset to one-half hour after sunrise.

## Night-time Short Duration Provisions

Provisions required for night-time short duration work, even though one or more may be shown as optional for daytime short duration operations illustrated in the layouts. See [Section 3.8.1](#). For night-time work of any duration, high visibility garments that meet OHSa requirements for night-time work must be used.

## Non-Freeway

Any section of highway within the limits of the designated construction zone not matching the criteria of a freeway. High volume and/or high-speed non-freeways may be designated by road authorities as freeways for the purpose of traffic control.

## Normal Posted Regulatory Speed (NPRS)

The regulatory maximum speed posted on a highway under normal conditions, that is, when no construction zone or work activity is present. Guideline provisions provided in OTM Book 7 are based on normal regulatory posted speed, not temporarily reduced construction zone regulatory or advisory speeds.

## NPRS

See Normal Posted Regulatory Speed.

## NTCIP

National Transportation Communications for ITS Protocol.

# O

## Object Marker

A traffic sign temporarily or permanently mounted on an obstruction, within or adjacent to a highway, to make the obstruction as highly visible as possible.

## Occupational Health and Safety Act (OHSa)

The Ontario Occupational Health and Safety Act and Regulations for Construction Projects by the Ontario Ministry of Labour, Training, and Skills Development (MLTSD).

## Off-Peak Period

The period of time, usually outside the morning and afternoon peak periods. If there is a midday peak with traffic volumes that equal or approach those in the a.m. or p.m. periods, then this midday peak should be excluded from the off-peak period.

**Off-Shoulder Work**

Work within the right-of-way, but completely beyond the shoulder of the highway such that workers, equipment, or vehicles (including parked vehicles) do not encroach onto the shoulder and no traffic control devices are required. Where a shoulder is not clearly defined, the work can be considered off-shoulder if the work area, including all work vehicles and equipment, is beyond 3.0 metres from the edge of the travelled portion of the highway. On provincial highways, off-shoulder work should comply with the Roadside Safety Manual.

**Official Sign**

Any sign approved by the MTO.

**OGRA**

Ontario Good Roads Association.

**OHSA**

See Occupational Health and Safety Act.

**OMB**

Ontario Municipal Board.

**Operating Speed**

The speed at which the majority of vehicles are travelling, typically the 85th percentile, regardless of the speed limit.

**OPS**

Ontario Provincial Standards.

**OPS/PMC**

Ontario Provincial Standards/Products Management Committee.

**Oversize Sign**

A traffic sign with greater proportional dimensions than the minimum dimensions specified in this manual. Such signs are generally required on higher speed highways, or other highways in special cases.

**P****Pace Vehicle (PV)**

Used to control the speed of vehicles through a work zone where speed control is required but is difficult to achieve by other means.

**Partial Lane Shift**

Where more than one lane is temporarily realigned and is used when encroachment of highway operations will result in a traffic lane width of less than 3.0 metres. However, squeezing all lanes to minimum will provide lane widths that are at least 3.0 m for each lane. See also Narrow Lanes and Roadside Diversions.

**Pavement**

The part of a highway that has a constructed hard surface for the facilitation of vehicular movement.

**Pavement Marking**

A coloured marking applied to the pavement to provide drivers with highway alignment information.

**PDO**

Paid Duty Officer.

**Peak Hour**

The one hour each day when traffic volumes are at their highest on a given highway.

**Peak Period(s)**

One or more periods each day, usually consisting of two or three hours, when traffic volumes are at their highest on a given highway, usually corresponding to a morning “to work” period and an afternoon “from work” period.

**Pedestrian**

Any person who is on foot, not in or on a vehicle, motorized or otherwise propelled, or riding on an animal.

**Perception-reaction Time**

The time required to make a decision, after reading or encountering a traffic control device, and initiate a maneuver if required.

**Permissive Symbol**

An annular (circular) green band used on a sign to signify that whatever is depicted within the symbol is permitted.

**Phase (Traffic Signal)**

A part of a cycle where one or more traffic movements receive a green indication at the same time. Phase time is the time required from the start to the finish of the phase, including amber and all-red interval times.

**Pilot Vehicle**

Used on a two-lane highway to guide, at an appropriate speed, a queue of vehicles through a one-lane section of a complex temporary traffic control zone or detour.

**PIP**

See Public Information Plan.

**PLCS**

See Portable Lane Control Signal.

**PMD**

See Post-Mounted Delineator.

**Portable Lane Control Signal (PLCS)**

Consists of at least one vehicle traffic signal head, normally mounted onto a movable pole/trailer, with programmable signal timing. The use of PLCS is an alternative to continuous flagging by TCP and are not to be confused with PTTS.

**Portable Temporary Traffic Signal (PTTS)**

Consists of two standard traffic signal heads mounted on movable trailers. On MTO contracts the trailers shall not be used at intersections to emulate traffic control signals.

**Portable Variable Message Sign (PVMS)**

Dynamic traffic control device capable of digitally displaying a variety of messages via elements on the face of the sign that can be activated to form letters or symbols. They provide guidance and information to highway users and can enhance static signs in temporary conditions.

**Positive Guidance**

Provision of information to highway users that they will need to avoid hazards, when and where they need it, in a form that they can best use it. See OTM Book 1C (Positive Guidance Toolkit).

**Posted Advisory Speed**

The maximum advisory speed as indicated by appropriate warning or temporary condition signs.

**Posted Speed Zone**

A section of highway upon which the maximum speed is indicated by appropriate regulatory signs.

**PPE**

Personal Protective Equipment.

**Pre-engineering and Engineering Activities**

Activities carried out in preparation for, during, or after completion of a construction project (e.g.,

surveying, geotechnical sampling or testing, pre-construction inspection). For the purposes of traffic control, pre-engineering activities are considered as a part of the construction work activities in OTM Book 7.

### **Provincial Highway**

Any public highway under the jurisdiction of the MTO. See King's Highway.

### **PTTS**

See Portable Temporary Traffic Signal.

### **Public Information Plan (PIP)**

Includes actions and procedures for informing the travelling public, the general public, area residences and businesses and, the local road authority about expected work zone impacts.

### **Public Highway**

Any highway under the jurisdiction of and maintained by a public authority and open to public travel.

### **Public Way**

A sidewalk, street, highway, square, or other open space to which the public has access, as a right or by invitation, either expressed or implied.

### **PV**

See Pace Vehicle.

### **PVMS**

See Portable Variable Message Sign.

## **R**

### **Railroad Crossing**

A location where one or more railroad tracks cross a public highway, road, street, or a private roadway, and includes sidewalks and pathways at or associated with the crossing.

### **Raised Pavement Marker**

A ceramic, metal, glass, or plastic marking device placed on or in the highway to substitute for or act as a supplement to standard pavement markings. Raised pavement markers comprise a variety of configurations, including retroreflective and non-retroreflective markers, and markers that employ prismatic and spherical retroreflectors.

### **Ramp**

An interconnecting highway of a traffic interchange, or any connection between highways at different levels or between parallel highways, on which vehicles may enter or leave a designated highway.



### Reading Time

The time required to read a sign with a given message.

### Reflectivity

A measure of the degree to which a surface reflects incident light. A related term, reflectance, is the amount of light reflected back from a sign, relative to the amount of light that shines on a sign. See Retroreflectivity, Coefficient of (R).

### Reflectorization

A method of incorporating light-reflective material on the approach face of a traffic sign so that the face will reflect light during the hours of darkness while retaining the same colours as by day.

### Regulation

A prescribed rule, supported by legislation, such as any regulation made under the HTA or OHSA or municipal by-law. Regulations provide the legal basis for enforcement.

### Regulatory Sign

A traffic sign that advises drivers of the action that they should or must do (or not do) under a given set of circumstances. Disregard of a regulatory sign usually constitutes as an offence.

### Retroreflective Material

A type of material applied in either strips or sheets which reflects illumination back to its source.

### Retroreflectivity, Coefficient of (R)

R indicates the proportion of light reflected back to the driver from a retroreflective sign surface, in candelas per lux per square metre. See Section 9.1 in OTM Book 1B (Sign Design Principles).

### Right-of-way

1. Allocation of right of movement to a road user, with preference over other road users.
2. The width of the road allowance from the property line on one side to the property line on the opposite side of a roadway.

### Road

See Highway.

### Road Authority

The body (municipal, provincial, or private) that has legal jurisdiction over a highway.

### Road Closure

The closing of a highway to road users. Road closures are covered by Regulation 599 of the HTA.

### Road Edge Work

Construction, maintenance, or utility work that encroaches onto the edge of a road, with much of the work being done on the shoulder. Road edge work is not fully on the shoulder, nor does it result in a remaining travel lane width that is less than 3.0 m (3.5 m on freeways), which would necessitate a lane closure or a partial lane shift. See also Roadside Work.

### Roadside Diversion

A deviation of a normal roadway, essentially within a highway right-of-way, where traffic is required to make a short diversion to bypass a work area. The diversion must be signed by using a TC-9, TC-16, and/or other appropriate signs.

### Roadside Work

Construction, maintenance, or utility work that is done on a shoulder or the edge of a road.

### Roadway

The part of the highway that is improved, designed, or ordinarily used for vehicular traffic, but does not include the shoulder, and where a highway includes two or more separate roadways, the term “roadway” refers to any one roadway separately and not to all of the roadways collectively.

### Roadway Alignment Sign

A warning sign or temporary condition sign used to inform drivers of an upcoming change in roadway alignment, including turns and curves.

### Roadway Edge Line

See Edge Line.

### Rolling Closure

A closure where lead vehicles such as police car(s), Crash Truck(s), and/or sign truck(s), are used to control the speed and restrain vehicles upstream of a construction site, so as to create a time window (usually 5 to 15 minutes) when the road downstream is effectively clear of vehicles. This creates an unhindered opportunity for workers to do work and/or make traffic control changes at the work site while clear of live traffic.

### Rotating LED Amber Lights

Rotating LED amber lights may replace 4WF plus 360-degree beacon on vehicles to enhance visibility and support field operations. The rotating LED amber lights must be positioned as a pair; one on the left and the other on the right, mounted and installed at a height so visible from 360 degrees around (for details, see [Section 4.5.1.3](#) in OTM Book 7).

### Route Detour

A detour where a driver is required to completely depart from the normal route and directed to use an alternate route. The alternative route must be signed by using a combination of the appropriate TC-10 directional signs. Prior to the closing of the roadway and opening of a detour, a TC-65 “Road

Closing Notice” sign must be erected at strategically selected locations of the road at least one week in advance of the actual closing.

### **Rural Area**

An area outside of the limits of any incorporated or unincorporated city, town, village, or any other designated residential or commercial area.

## **S**

### **SAE**

Society of Automotive Engineering (SAE International).

### **Safe Stopping Distance**

The distance required to completely and safely bring a vehicle to rest with normal braking and road conditions.

### **SD**

See Short Duration Work.

### **Shall**

Means the same as “must”.

### **Short Duration (SD) Work**

Short Duration work refers to activities that require work areas that are continuously occupied by workers and/or equipment, for more than 30 minutes but less than one 24-hour period in duration.

### **Should**

Indicates an advisory condition. Where the word “should” is used, the action is advised; recommended but not mandatory. This term is meant to suggest good practice in most situations, but also to recognize that in some situations, for good reasons, the recommended action cannot or need not be followed.

### **Shoulder**

That portion of the highway between the edge of the travelled portion of the highway and the curb or point of intersection of the slope lines at the outer edge of a highway and the fill, ditch, or median slope, for the accommodation of stopped vehicles, emergency vehicles, and for lateral support.

### **Sight Distance**

The distance visible to the driver of a vehicle, measured along the normal travel path of a roadway, to the roadway surface or a specified height above a roadway, when the view is unobstructed by traffic.

**Sign**

A traffic control device mounted on a fixed or portable support which conveys a specific message by means of symbols or words, and is officially installed for the purpose of regulating, warning, or guiding traffic.

**Sign Assembly**

Any traffic sign mounted and installed alone or in conjunction with any combination of associated tab signs.

**Sign Blank Number**

The number conferred to a given size of a standard size blank (substrate), for the purposes of identification, inventory, and fabrication.

**Sign Pattern**

The full-size hard copy drawings or electronic images of individual signs, which show sufficient detail and dimensional accuracy for sign fabrication.

**Sign Sheeting**

The retroreflective material used on the surface of a sign to provide good daytime and night-time visibility.

**Sign Support**

The physical means of holding a sign in its intended position.

**Sign Symbol**

A pictogram, depiction, arrow, silhouette or figures, and/or interdictory or permissive symbols, used to simplify or represent a word message on a sign.

**Sign Truck (ST)**

A vehicle that has:

1. Four-way flashers and a mounted flashing arrow board sign, or
2. A portable trailer with a mounted flashing arrow board sign.

**Signal Indication (Traffic Signal)**

The illumination of one or more lenses in a signal head which conveys a message to traffic that is approaching the signal from one direction.

**Signalized Control**

The use of a traffic signal control device to control traffic on a road section or intersection.

**SMD**

Saddle-Mounted Delineator.

**Speed Change Lane**

A tapered auxiliary traffic lane used by traffic that is entering or leaving a freeway or expressway for the purpose of acceleration or deceleration, respectively.

**Speed Limit**

The maximum vehicular speed allowed within any given posted or unposted speed zone.

**Speed Zone**

A specific section of roadway upon which a maximum speed limit has been imposed. Such zones may be posted or unposted. A construction speed zone must be posted.

**ST**

See Sign Truck.

**Standard**

A rule, principle, pattern, or measure, which practice or theory has shown to be appropriate for a given set of conditions, and applicable, as the case may be, to planning, design, traffic control devices, operations, or maintenance.

**Statutory Speed Limit**

A maximum speed limit automatically in effect on all roads, unless otherwise signed. The statutory speed limit applies even where no maximum speed limits are signed.

**Stopping Sight Distance**

The distance required by a driver of a vehicle, travelling at a given speed, to bring the vehicle to a stop after an object on the roadway becomes visible. It includes the distance travelled during the perception-reaction time and the vehicle braking distance.

**Street**

An urban highway.

**Striper**

A self-contained marking system mounted on a truck chassis and used to apply pavement markings on the road.

**Substrate**

The surface on which sign sheeting is applied.

**SWTTS**

Span Wire Temporary Traffic Signal.

**T****Tab Sign**

A sign which is smaller than its associated primary sign, and mounted below it. There are two types of tab signs:

1. Supplementary tab signs – contain additional, related information, and
2. Educational tab signs – convey the meaning of symbols during their introductory period.

**TAC**

Transportation Association of Canada.

**Tangent Section**

1. A straight section of roadway between curves.
2. In temporary conditions, the distance between the end of one taper and the beginning of the next taper, where more than one lane is being closed.

**Taper**

The gradual narrowing of a lane which is intended to safely guide drivers into an adjacent lane. The taper length is the length of the section of roadway required to achieve full lane closure (e.g., construction zone) or full lane transition.

**TC**

See Temporary Conditions.

**TCTM**

See Temporary Conditions Traffic Management Manual.

**TCP**

See Traffic Control Person.

**Temporary Conditions (TC)**

Roadway and traffic control conditions related to non-permanent construction, maintenance, and utility work on any highway open to the public.

**Temporary Conditions Traffic Management (TCTM) Manual**

Manual published by Ministry of Transportation Central Region Traffic Office to promote uniformity of treatment in the design, selection, application and operation of temporary conditions traffic management systems on provincial highways within the Ministry of Transportation's Central Region.

### Temporary Construction Barrier System (TCBS)

A portable barrier system consisting of segments, commonly in lengths of 2.5 m to 4.0 m that are positively connected to form a continuous barrier. The most common barrier system, temporary concrete barriers, used in Ontario must meet the requirements of the Ontario Provincial Standards Specifications and placed in accordance with the Ontario Roadside Safety Manual.

### Temporary Pavement Marking

Temporary pavement markings are used during temporary conditions to mark the intended vehicle path that traffic is to follow, normally in combination with appropriate warning signs, channelizing devices, and delineation.

### Temporary Raised Pavement Marker (TRPM)

Temporary raised pavement marker is a ceramic, metal, glass, or plastic marking device placed on the highway to substitute for or act as a supplement to standard pavement markings (for details, see [Section 4.2.6.1](#) in OTM Book 7, and OTM Book 11 (Pavement, Hazard and Delineation Markings)).

### Temporary Sign

A regulatory, warning, or guide sign, intended to be used for temporary conditions.

### Temporary Traffic Signal (TTS)

A temporary traffic signal installed to control traffic at a crossing, such as a temporary roadway, truck access route, pedestrian crossing, etc. A temporary traffic signal must comply with Section 144(31) of the HTA. The design specifications for temporary signals, which require prior approval by the appropriate road authority, are specifications which apply to permanent traffic control signals at signalized intersections (for details, see [Section 4.4.3.4](#) in OTM Book 7, and OTM Book 12 (Traffic Signals)).

### Temporary Transverse Rumble Strips

Also called in-lane or travel-way rumble strips, are grooved or raised corrugations that are placed on the highway pavement surface perpendicular to the path of travel, such that motor vehicles passing over the corrugations simultaneously generate audible and vibratory stimuli. Used to alert motorists that they are about to enter a work zone where an unusual or unexpected highway condition exists, to bring driver's attention to other warning devices, or a change in the highway ahead that requires a speed reduction or stop.

### Termination Area

Area where traffic makes the transition back to the normal path of a road. Termination area is the sixth and last component of a work zone. Termination Area extends from the downstream end of the work area to the point where traffic is able to resume normal driving, typically at the end of the delineation of the termination taper on multi-lane divided highways, or at the TC-2 in the opposing direction of an undivided highway.

**The Road Authority (TRA)**

A web-based database application that provides an information resource on roadway products, services, and technologies used in the province.

**TMA**

See Truck (or Trailer) Mounted Attenuator.

**TMP**

See Transportation Management Plan.

**TOP**

See Traffic Operations Plan.

**TPP**

See Traffic Protection Plan.

**TRA**

See The Road Authority.

**Traffic Cone**

ATC-51 channelization and delineation device.

**Traffic Control Device**

Any sign, signal, marking, or device placed upon, over, or adjacent to a roadway by a public authority or official, or private road owner, with jurisdiction, for the purpose of regulating, warning, guiding, or informing road users.

**Traffic Control Installer**

A person duly trained and authorized to install and remove traffic control devices in a work zone.

**Traffic Control Person (TCP)**

A person duly trained and authorized to manually regulate vehicle traffic using a TC-22 TRAFFIC CONTROL SIGN (STOP/SLOW Paddle), and often arm motions, to prevent conflicts between workers, work zone activities, opposing highway traffic, work vehicles, and pedestrians.

**Traffic Control Plan**

A detailed plan for the control of traffic during construction, maintenance, or utility operations on a highway, taking into account the organized, systematic, safe conduct of a project, including, as applicable, detours, staging sequences, work vehicle access to and departure from work sites, temporary barriers, removal of old pavement markings, and selection and planned implementation of appropriate layouts for traffic control.



### **Traffic Control Signal (Traffic Signal)**

Any power-operated traffic control device with at least three signal lenses, whether electrically or mechanically operated, by which traffic is alternately directed to stop and permitted to proceed.

1. When used in general discussions, a traffic signal is a complete installation including signal heads, wiring, controller, poles, and other instruments.
2. When specifically used, the term refers to the signal head which conveys a message to the observer.
3. The part of a traffic control signal system that consists of one set of no less than three coloured lenses; red, amber, and green, mounted on a frame and commonly referred to as a signal head.

### **Traffic Count**

A record of the number of vehicles or people aboard vehicles, or both, and pedestrians that pass a given checkpoint during a given time period.

### **Transportation Operations Plan (TOP)**

A Transportation Operations Plan (TOP) includes strategies used to mitigate work zone impacts using improved traffic operations and management techniques. Strategies include vehicle restriction strategies, alternative traffic flow strategies, and improvements to the transportation network because of restrictions (signal timing modifications or detour routes).

### **Traffic Protection Plan (TPP)**

A plan required by the OHSA and its regulations for the protection of workers in a work zone. The plan must contain a written description of the traffic hazards to which workers may be exposed and measures used to protect them.

### **Traffic Sign**

A device (other than markings, delineators, and traffic control signals) which may be installed beside or above a roadway for the purpose of regulating, warning, or guiding traffic.

### **Traffic Signal Control System**

An area or corridor signal system under signalized control.

### **Transition Area**

The third component of a work zone, downstream from the approach area, and upstream of the longitudinal buffer area, where traffic is channelled from a normal path to a new path required to move traffic past a work space. The transition area contains the tapers and parallel tangent sections (if more than one lane closed) that are used to close the lanes effectively. Work material, vehicles, and equipment must not be stored or parked in transition areas.

### **Transportation Management Plan (TMP)**

A coordinated set of strategies and work zone safety guiding principles designed to mitigate the impacts of work zone activities during the work period. Inclusion of these strategies can help achieve the fundamental principles for work zone planning, design, and operation.

### **TRPM**

See Temporary Raised Pavement Marker.

### **Truck**

A commercial vehicle that exceeds a specified weight or length as defined by the HTA, municipal by-law, or toll agency.

### **Truck (or Trailer) Mounted Attenuator (TMA)**

An energy-absorbing device mounted on the rear of a truck, which deforms on impact in a controlled manner, thereby reducing the rate of:

1. Deceleration (and associated injury) for the occupants of a vehicle that has struck the TMA from the rear; and
2. Acceleration (and associated injury) for the driver of the truck.

TMA must satisfy the requirements of NCHRP 350 Level TL-2 (70 km/h) or TL-3 (100 km/h) and should be selected for the appropriate posted speed. All TMA used on freeways must satisfy the TMA TL-3 requirement (100 km/h).

### **TTS**

See Temporary Traffic Signal.

### **Turn Lane**

A lane designated to facilitate vehicular turn movements from a through roadway.

### **Turn Prohibition**

A regulation that prohibits a straight-through movement or a left/right turn at an intersection. Turn prohibitions are sometimes used in association with barriers that physically prevent a turn from being made.

### **Two-lane Highway**

Highways with a single lane dedicated to each direction in two-way traffic.

### **Two-way Left-turn Lane**

The centre lane on some of the three, five, or seven lane sections of undivided highways which is designed to facilitate left turns from each direction.

## U

### Undivided Highway

Highway that does not physically divide the two-way traffic. The two opposing directions are delineated with yellow pavement markings.

### Upstream

The direction that traffic is coming from.

### Urban Area

An area within the limits of any incorporated or unincorporated city, town, village, or any other designated residential or commercial area with a high density of population and infrastructure.

## V

### Vehicle

Includes a motor vehicle, trailer, traction engine, farm tractor, road-building machine, bicycle, and any vehicle drawn, propelled, or driven by any kind of power, including muscular power, but does not include a motorized snow vehicle or motorcycle sidecar.

### Vehicle Arresting System

Portable netting, cables, and energy-absorbing anchors designed to gradually slow down errant vehicles and prevent penetration into activity areas. Used to prevent errant vehicles from entering the work space when sections of a highway are frequently opened and closed during extended work operations.

### Very Short Duration (VSD) Work

Any work activity which occupies a fixed location for up to 30 minutes in duration, including set-up and takedown of the traffic control provisions (e.g., some utility work, minor road maintenance, stormwater catchbasin cleanout, etc.). The work site may be moved along the road and make frequent, short stops.

### VMS

See Variable Message Sign.

### Volume

The number of vehicles or pedestrians that pass over a given section of a lane or highway, or make a particular movement during a specific time period (such as one hour or 24 hours).

### VSD

See Very Short Duration (VSD) Work.

## W

### Warning Sign

A sign which indicates conditions on or adjacent to a highway or street that are actually or potentially hazardous to traffic operations.

### Work Area

Areas where the work takes place and/or equipment and material are stored. Work area is the fifth component of a work zone, downstream from the LBA and upstream of the termination area. Work areas may or may not contain a work vehicle. Work areas may be in a fixed location or move as work progresses. There may be more than one work area within a work zone. It is still considered a work area when work has temporarily stopped yet the road has not returned to its normal operation conditions.

### Work Site Identification

Visible identification of the work area by passive and/or active traffic control devices to show road users where work is taking place.

### Work Zone

An area, usually made up of six component areas, where traffic control devices have been set up to provide positive guidance to highway users through a temporary situation and include the entire section from the first advance warning sign through to the last traffic control device, where traffic returns to its normal path and conditions. A work zone can be in the travelled portion of the road or on the boulevard or shoulders and may be stationary or mobile. See Mobile Operations, Very Short Duration, Short Duration, and Long Duration Work.

## WT

WorkTruck.

## Y

### Yield

To cede the right of way.

## C

## Appendix C: References

**Referenced Documents:**

American Road & Transportation Builders Association/Texas Transportation Institute. (1999) Equipment Details. Screen-Safe™ Highway Glare Screen & Work Zone Safety Shield. [Internet], [http://www.workzonesafety.org/safety\\_products/record/10101](http://www.workzonesafety.org/safety_products/record/10101) (equipment link: TranspoR Industries, Inc. <http://www.transpo.com/>).

American Society of Testing and Materials (ASTM). (1999) Specification D 4956-19. Standard Specification for Retroreflective Sheeting for Traffic Control. West Conshohocken, PA.

American Traffic Safety Services Association (The). (1993) Quality Standards for Work Zone Traffic Control Devices. [Internet]. Fredericksburg, VA. American Traffic Safety Services Association.

Canadian General Standards Board. (1978) Specification 62-GP-11M (Amendment No. 2, 1987).

Canadian Standards Association (CSA). (2015) CSA Z96-15 High-Visibility Safety Apparel. Toronto, ON.

Colavincenzo, O. and Harmelink, M. (2001) Protection of Workers in a Work Zone from Errant Vehicles, ON. Dillon Consulting Ltd.

Government of Canada. (2014) Grade Crossing Regulations. [Internet], <https://laws-lois.justice.gc.ca/eng/regulations/SOR-2014-275/>. Ottawa. Minister of Justice.

Health and Safety Ontario. (1994) Handbook for Construction Traffic Control Persons. [Internet], <https://www.ihsa.ca/PDFs/Products/Id/B016.pdf>. Mississauga, ON. Infrastructure Health & Safety Association.

Ministry of Transportation - Ontario and Municipal Engineering Association. (2020) Ontario Provincial Specification Standards (OPSS). ON.

Ministry of Transportation - Ontario. (2020) Roadside Design Manual. [Internet], <https://www.library.mto.gov.on.ca/SydneyPLUS/Sydney/Portal/default.aspx?lang=en-US>. St. Catharines, ON. Ministry of Transportation Ontario.

Ministry of Transportation - Ontario. (2020) MTO Design Supplement for TAC Geometric Design Guide (GDG) for Canadian Roads. St. Catharines, ON. Ministry of Transportation Ontario.

Ministry of Transportation – Ontario (2000). Temporary Conditions Traffic Management; Advance Notification, Advance Warning and Alternative Route Signing for Provincial Highways in MTO Central Region. For use on Provincial Highways and other roadways in MTO's Central Region. Downsview, ON. Central Region Traffic Office.

Ministry of Transportation – Ontario. (1999) Proposed PVMS Message Format for Incident Management/ Construction Closures on Standard Provincial Highways.

Ministry of Transportation – Ontario (MTO). (2005) Ontario Traffic Manual. Book 1. Introduction to the Traffic Manual. [Internet], <https://www.library.mto.gov.on.ca/SydneyPLUS/Sydney/Portal/default.aspx?lang=en-US>. St. Catharines, ON. Ministry of Transportation Ontario.

Ministry of Transportation – Ontario (MTO). (2001) Ontario Traffic Manual. Book 1A. Introduction to the Ontario Traffic Manual. Appendix A – Illustrated Sign and Signal Display Index. [Internet], <https://www.library.mto.gov.on.ca/SydneyPLUS/Sydney/Portal/default.aspx?lang=en-US>. St. Catharines, ON. Ministry of Transportation Ontario.

Ministry of Transportation – Ontario (MTO). (2001) Ontario Traffic Manual. Book 1B. Introduction to the Ontario Traffic Manual. Appendix B – Sign Design Principles. [Internet], <https://www.library.mto.gov.on.ca/SydneyPLUS/Sydney/Portal/default.aspx?lang=en-US>. St. Catharines, ON. Ministry of Transportation Ontario.

Ministry of Transportation – Ontario (MTO). (2001) Ontario Traffic Manual. Book 1C. Introduction to the Ontario Traffic Manual. Appendix C – Positive Guidance Toolkit. [Internet], <https://www.library.mto.gov.on.ca/SydneyPLUS/Sydney/Portal/default.aspx?lang=en-US>. St. Catharines, ON. Ministry of Transportation Ontario.

Ministry of Transportation – Ontario (MTO). (2005) Ontario Traffic Manual. Book 2. Sign Design, Fabrication and Patterns. [Internet], <https://www.library.mto.gov.on.ca/SydneyPLUS/Sydney/Portal/default.aspx?lang=en-US>. St. Catharines, ON. Ministry of Transportation Ontario.

Ministry of Transportation – Ontario (MTO). (2020) Ontario Traffic Manual. Book 4. Ground-Mounted Sign and Support Inspection and Maintenance. [Internet], <https://www.library.mto.gov.on.ca/SydneyPLUS/Sydney/Portal/default.aspx?lang=en-US>. St. Catharines, ON. Ministry of Transportation Ontario.

Ministry of Transportation – Ontario (MTO). (2020) Ontario Traffic Manual. Book 5. Regulatory Signs. [Internet], <https://www.library.mto.gov.on.ca/SydneyPLUS/Sydney/Portal/default.aspx?lang=en-US>. St. Catharines, ON. Ministry of Transportation Ontario.

Ministry of Transportation – Ontario (MTO). (2020) Ontario Traffic Manual. Book 6. Warning Signs. [Internet], <https://www.library.mto.gov.on.ca/SydneyPLUS/Sydney/Portal/default.aspx?lang=en-US>. St. Catharines, ON. Ministry of Transportation Ontario.

Ministry of Transportation – Ontario (MTO). (2010) Ontario Traffic Manual. Book 8. Guide and Information Signs. [Internet], <https://www.library.mto.gov.on.ca/SydneyPLUS/Sydney/Portal/default.aspx?lang=en-US>. St. Catharines, ON. Ministry of Transportation Ontario.

Ministry of Transportation – Ontario (MTO). (2000) Ontario Traffic Manual. Book 11. Pavement, Hazard and Delineation Markings. [Internet], <https://www.library.mto.gov.on.ca/SydneyPLUS/Sydney/Portal/default.aspx?lang=en-US>. St. Catharines, ON. Ministry of Transportation Ontario.

Ministry of Transportation – Ontario (MTO). (2012) Ontario Traffic Manual. Book 12. Traffic Signals. [Internet], <https://www.library.mto.gov.on.ca/SydneyPLUS/Sydney/Portal/default.aspx?lang=en-US>. St. Catharines, ON. Ministry of Transportation Ontario.

Ministry of Transportation – Ontario (MTO). (2016) Ontario Traffic Manual. Book 15. Pedestrian Crossing Treatments. [Internet], <https://www.library.mto.gov.on.ca/SydneyPLUS/Sydney/Portal/default.aspx?lang=en-US>. St. Catharines, ON. Ministry of Transportation Ontario.

Ministry of Transportation – Ontario (MTO). (2020) Ontario Traffic Manual. Book 18. Cycling Facilities. [Internet], <https://www.library.mto.gov.on.ca/SydneyPLUS/Sydney/Portal/default.aspx?lang=en-US>. St. Catharines, ON. Ministry of Transportation Ontario.

Province of Ontario (1986). Public Transportation and Highway Improvement Act; Revised Statutes of Ontario, 1990, and the Regulations thereunder (as amended), 2020. ON.

Province of Ontario (2001). Municipal Act; Revised Statutes of Ontario. Statutes of Ontario, 2001, as amended, 2020. ON.

Province of Ontario. (1990) Highway Traffic Act (HTA); Office Consolidation; Revised Statutes of Ontario, 1990, and the Regulations thereunder (as amended), 2020. ON.

Province of Ontario. (1990) Ontario Health & Safety Act and Regulations for Construction Projects; Revised Statutes of Ontario, 1990, Revised Regulations of Ontario 213/91 as amended by 631/94 and 145/00, 2020. Ontario Ministry of Labour.

Transportation Association of Canada. (2017) Geometric Design Guide for Canadian Roads. Ottawa. Transportation Association of Canada.

Transportation Association of Canada. (2014) Manual of Uniform Traffic Control Devices for Canada; Fourth Edition. Ottawa. Transportation Association of Canada.

U.S. Department of Transportation. (2009) Manual of Uniform Traffic Control Devices; Part VI, Standards and Guides for Traffic Controls for Street and Highway Construction. Maintenance, Utility, and Incident Management Operations, 2009 Edition of MUTCD. Washington, D.C. Federal Highway Administration.

U.S. Department of Transportation. (2009) Manual of Uniform Traffic Control Devices. Washington, D.C. Federal Highway Administration.

### **Additional References and Literature Reviewed:**

Alberta Transportation (2008) Traffic Accommodation in Work Zones. [Internet]. Edmonton, AB.

American Traffic Safety Service Association. (2011) Pedestrian Safety and Accessibility in Work Zones. [Internet]. USA.

American Traffic Safety Services Association (The) (ATSSA). (2010) Guidelines on the Use of Positive Protection in Temporary Traffic Control Zones. [Internet]. Fredericksburg, VA. Federal Highway of Administration.

American Traffic Safety Services Association (The) (ATSSA). (2009) Work Zone Positive Protection Toolbox. [Internet] Fredericksburg, VA. Federal Highway Administration.

Antonucci, N.D., Hardy, K.K., Bryden, J.E., Neuman, T.R., Pferer, R. & Slack K. (2005) Guidance for Implementation of the AASHTO Strategic Highway Safety Plan Volume 17: A Guide for Reducing Work Zone Collisions. Washington D.C.

- Bligh,R.P, Menges,W.L. & Haug,R.R. (2006) Crashworthy Work-Zone Traffic Control Devices. Washington,D.C.
- British Columbia Ministry of Transportation and Infrastructure. (2015) Traffic Management Manual for Work on Roadways. [Internet]. Victoria, BC.
- CAA South Central Ontario. (2009) Emergency Road Service Manual.
- Campbell,J.L., Richard,C.M., Brown,J.L., Lichty,M.G., Graham,J. & O’Laughlin,M. (2010) Human Factors Guidelines for Road Systems Collection C: Chapters 16, 17, 18, 19, 20, 22 (Tutorials 4, 5, 6), 23. (Updated),24, 25, 26 (Updated).Washington, D.C.
- Canadian Centre for Occupational Health and Safety (CCOHS). (2020) High-Visibility Safety Apparel. [Internet], [https://www.ccohs.ca/oshanswers/prevention/ppe/high\\_visibility.html](https://www.ccohs.ca/oshanswers/prevention/ppe/high_visibility.html). Hamilton, ON.
- Centre for Health and Safety Innovation (2001) Guidelines for a Traffic Protection Plan. Mississauga, ON.
- CDED Special Provisions Archive Document. <https://www.library.mto.gov.on.ca/SydneyPLUS/TechPubs/Portal/tp/TechnicalPublications.aspx>.
- City of Saskatoon. (2017) Temporary Traffic Control Manual. [Internet]. Saskatoon, SK.
- Construction Safety Association of Ontario. (2010) Handbook for Construction Traffic Persons. [Internet]. Mississauga, ON. Infrastructure Health & Safety Association.
- District Department of Transportation. (2004) DC: Temporary Traffic Control Manual. [Internet]. Washington, DC
- Dunn, W.M. & Latoski,S,P. (2003) A Synthesis of Highway Practice. Washington, D.C.
- Ellis,R.D., Amos,S. & Kumar,A. (2003) Illumination Guidelines for Nighttime Highway Work. Washington, D.C.
- Elvey, R. and Morall, J. (2003) Emergency Traffic Management. In: Transportation Association of Canada, The Transportation Factor 2003 Annual Conference of the Transportation Association of Canada. St. John’s, Newfoundland and Labrador. September 21 to 24, 2003. Transportation Association of Canada: Ottawa, ON.
- Federal Highway Administration (FHWA). (2019) Improving Pedestrian and Bicyclist Safety in Work Zones. Washington, D.C.
- Florida Department of Law Enforcement (2006) Traffic Crash Investigations. Tallahassee, FL.
- Garber & Zhao. (2002) Crash Characteristics at Work Zones [Internet]. Virginia Transportation Research Council.
- Illinois Department of Transportation Bureau of Safety Programs and Engineering. (2016) Traffic Control Field Manual for IDOT Employees. [Internet]. Springfield, IL.
- Infrastructure Health & Safety Association (2011) Guidelines for Training Traffic Control Persons. Mississauga, ON.
- Infrastructure Health & Safety Association. (2010) Construction Health and Safety Manual. Mississauga, ON.



- Institute of Transportation Engineers. (1999) Transportation and Traffic Engineering Handbook. Washington, D.C.
- Iowa State University. (2002) Synthesis of Best Practice for Increasing Protection and Visibility of Highway Maintenance Vehicles. Ames, IA.
- Mahoney, K.M., Porter, R.J., Taylor, D.R., Kulakowski, B.T. & Ullman, G.L. (2006) Final Report For NCHRP Report 581: Design of Construction Work Zones on High-Speed Highways. Washington, D.C.
- Mahoney, K.M., Porter, R.J., Taylor, D.R., Kulakowski, B.T. & Ullman, G.L. (2007) Design of Construction Work Zones on High-Speed Highways. Washington, D.C.
- Manitoba Infrastructure and Transportation. (2015). Manitoba: Work Zone Traffic Control Manual [Internet]. Winnipeg, MB.
- Michigan Department of Transportation. (2007) Michigan: Maintenance Work Zone Traffic Control Guidelines [Internet]. Lansing, MI.
- Migletz, Graham et al. (1999) Work Zone Speed Limit Procedure [Internet]. Transportation Research Record: Journal of the Transportation Research Board 1657 p. 24-30.
- Ministry of Labour. (2003) Fire Fighters Guidance Note # 6-10. Toronto, ON.
- Ministry of Transportation – Ontario (MTO). (1995) Turning Orange: Construction Zones in Ontario. RoadTalk. [Internet], June 1995, Vol 15 (3).
- Ministry of Transportation – Ontario (MTO). (1995) Reducing Headlight Glare. RoadTalk. [Internet], June 1995, Vol 1 (3), p. 2.
- Ministry of Transportation - Ontario (MTO). (2009) Quantm Route Selection: No Stone Left Unturned. Road Talk. [Internet], Spring 2009, Vol 15 (3), p.1.
- Ministry of Transportation - Ontario (MTO). (2009a) Portable Variable Message Signs (PVMS). Best Practices Manual. ON. Advanced Traffic Management Section.
- Ministry of Transportation - Ontario (MTO). (2009b) MTO's Designated Sources for Materials. General Requirements for Listing of Vendors and Products. [Internet]. St. Catharines, ON. Design and Contract Standards Office, Ministry of Transportation.
- Ministry of Transportation - Ontario (MTO). (2011). Fluorescent Orange Temporary Pavement Markings. Policy Number: 2011-01. St. Catharines, ON. Traffic Office, Highway Standards Branch.
- Ministry of Transportation - Ontario (MTO). (2008) Portable Temporary Traffic Signals Policy. Policy Number: 2008-03. [Internet]. St. Catharines, ON. Traffic Office, Ministry of Transportation.
- Ministry of Transportation - Ontario (MTO). (2011) Innovative Mobile Work Zone Barrier on Highway 115 Project. RoadTalk. [Internet], Winter 2011, Vol 17 (1), p. 1.
- Ministry of Transportation Ontario (MTO) (2009) Guidelines for Accommodating Cyclists in Construction Zones and Road Closures. Ottawa, ON.

Minnesota Department of Transportation. (2005) Minnesota: MUTCD – Temporary Traffic Control [Internet]. Roseville, MN.

Mobile Barriers LLC. (2009-2010) Mobile Barriers® Mobile Barriers & Protected Areas for: Road & Bridge Construction & Maintenance, Airport Maintenance, Security, Defense and Other Applications. [brochure].

Mobile Barriers LLC. (2007-2012) Mobile Barriers® Mobile Work Zones Mobile Security. [Internet], <http://www.mobilebarriers.com/>.

Morales, J.M. (2009) Safe and Effective Use of Law Enforcement Personnel in Highway Work Zones: Pocket Guide. [Internet]. Fredericksburg, VA. American Traffic Safety Services Association.

National Cooperative Highway Research Program (NCHRP). (2009) Improving the Safety of Mobile Lane Closures. Washington, D.C.

New Brunswick Department of Transportation. (2009) New Brunswick: Work Area Traffic Control Manual [Internet]. Fredericton, NB.

Newfoundland and Labrador Department of Transportation and Works. (2014) Traffic Control Manual [Internet]. St. John's, NL.

New York State Department of Transportation. (2015) Work Zone Traffic Control [Internet]. Albany, NY.

Nova Scotia Department of Transportation and Infrastructure Renewal. (2018) Nova Scotia: Temporary Workplace Traffic Control Manual [Internet]. Halifax, NS.

NZ Transport Agency. (2011) Trials of traffic control devices – Guidelines. Wellington, NZ. Ontario,

Oregon Department of Transportation. (2016) Oregon: Temporary Traffic Control Manual [Internet]. Salme, OR.

Oregon Department of Transportation. (2017) Transportation Management Plan (TMP), 2nd Edition [Internet]. Salme, OR.

Province of Nova Scotia. (2006) Traffic Management Guidelines for Emergency Scenes. Halifax, NS. Quixote

Québec the ministère des Transports. (2017) Roadwork Signing [Internet]. Montréal, QC.

ResponderSafety.com. (2008) SOP SOG For Your Fire Department Safe Positioning While Operating or Near Moving Traffic.doc [Internet]. USA. Office of Justice Programs, U.S. Department of Justice.

Road Authority, The. (2011). The Road Authority [Internet], ON. ASI Technologies Inc.

SAE International. (2019). J845 Optical Warning Devices for Authorized Emergency, Maintenance, and Service Vehicles. Warrendale, PA.

Saskatchewan Ministry of Highways and Infrastructure. (2017) Traffic Control Devices Manual [Internet]. Saskatoon, SK.

Science Applications International Corporation American Transportation Research Institute. (2010) Traffic Incident Management Handbook Update. Washington, D.C.

State of California, Business, Transport and Housing Agency, Department of Transportation. (2006) California Manual on Uniform Traffic Control Devices (2006) [Internet]. Sacramento, CA.

Transportation Association of Canada. (2005) Synthesis of Practices for Speed Zone Management. Ottawa. Transportation Association of Canada.

Transportation Association of Canada. (2016) National Guidelines for Work Zone Safety in Canada. Ottawa. Transportation Association of Canada.

Transportation Research Board of the National Academies. (2007) Making Night Work Zones Safe Reports 475 and 476; CRP-CD-50. [Internet]. USA. National Cooperative Highway Research Program.

Transportation Research Board. (1994) Highway Capacity Manual, 3rd Edition. Washington, D.C.

Transportation Safety Inc. (2007) Safe-HitR Product Catalog.

University of Wisconsin-Madison Department of Civil and Environmental Engineering. (2018) Guidelines for Work Zone Designers - Pedestrian & Bicycle Accommodation [Internet]. Madison, WI.

U.S. Department of Transportation (1994) Roadway Delineation Practices Handbook. Washington, D.C. Federal Highway Administration.

U.S. Department of Transportation, Federal Highway Administration. (2009) Traffic Control Concepts for Incident Clearance. Washington, D.C.

U.S. Department of Transportation, Federal Highway Administration. (2009) US: Manual on Uniform Traffic Control Devices - MUTCD (FHWA) [Internet]. Washington, D.C.

U.S. Department of Transportation. (2009) Manual on Uniform Traffic Control Devices for Streets and Highways. [Internet]. Washington, D.C. Federal Highway Administration.

Ullman, G.L., Finley, M.D., Bryden, J.E., Srinivasan, R. & Council, F.M. (2008) Traffic Safety Evaluation of Nighttime and Daytime Work Zones. Washington, D.C.

Virginia Department of Transportation. (2012) Work Zone Safety - Guidelines for Temporary Traffic Control [Internet]. Richmond, VA.

Washington State Department of Transportation. (2012) Work Zone Traffic Control Guidelines [Internet]. Olympia, WA.

**Ontario** 

**Book**  
**7**

**Ontario  
Traffic  
Manual**

**April 2022**